



Z4 / Z8

SAMPLER

AKAI
professional



User Guide

WARNING

To prevent fire or shock hazard,
do not expose this appliance to
rain or moisture.

取扱説明書

ご使用になる前に、必ずこの
使用説明書をよくお読み下さい。

Important Notice

The material in this document is copyright to AKAI professional M.I. Corp., and may not be quoted or reproduced in any form without written permission from the company.

LIMITED SOFTWARE WARRANTY POLICY

All the software provided with, or purchased especially for, AKAI professional products has been tested for functionality. AKAI professional M.I. Corp. will make its best efforts to correct reported software defects for future releases subject to technical practicabilities.

AKAI professional M.I. Corp. makes no warranty or representation either expressed or implied with respect to the system's performance or fitness for a particular purpose.

In no event will AKAI professional M.I. Corp. be liable for direct or indirect damages arising from any defect in the software or its documentation. Further, AKAI professional M.I. Corp. will not accept any liability for any programs, sounds, audio recording or sequences stored in or used with AKAI professional products, including the cost of recovery of such data.

The warranties, remedies and disclaimers above are exclusive and take precedence over all others, oral or written, express or implied, to the extent permitted by law in the geographical area of the product's use. No employee of AKAI professional M.I. Corp., agent, distributor or employee of an agent or distributor is authorised to offer any variation from this policy.

WARNING!!

To prevent fire or shock hazard, do not expose this appliance to rain or moisture.

1-En

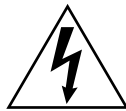

CAUTION
RISK OF ELECTRIC SHOCK
DO NOT OPEN



CAUTION: TO REDUCE THE RISK OF ELECTRIC SHOCK
DO NOT REMOVE COVER (OR BACK).
NO USER-SERVICEABLE PARTS INSIDE.
REFER SERVICING TO QUALIFIED SERVICE PERSONNEL.

THE SYMBOLS ARE RULED BY UL STANDARDS (U.S.A.)

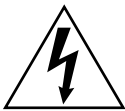

The lightning flash with arrowhead symbol, within an equilateral triangle, is intended to alert the user to the presence of uninsulated "dangerous voltage" within the product's enclosure; that may be of sufficient magnitude to constitute a risk of electric shock to persons.



The exclamation point within an equilateral triangle is intended to alert the user to the presence of important operating and maintenance (servicing) instructions in the literature accompanying the appliance.

5B-En

Lithium battery

This product uses a lithium battery for memory backup.

The lithium battery should only be replaced by qualified service personnel.

Improper handling may cause risk of explosion.

24A-En

WARNING: WHEN USING ELECTRIC PRODUCTS, BASIC PRECAUTIONS SHOULD ALWAYS BE FOLLOWED, INCLUDING THE FOLLOWING:**WARNING**

The Z4/Z8 is designed to be used in a standard household environment.

Power requirements for electrical equipment vary from area to area. Please ensure that your Z4/Z8 meets the power requirements in your area. If in doubt, consult a qualified electrician or AKAI professional dealer.

120 VAC	@ 60 Hz for USA and Canada
220~240 VAC	@ 50 Hz for Europe
240 VAC	@ 50 Hz for Australia

PROTECTING YOURSELF AND THE Z4/Z8

- Never touch the AC plug with wet hands.
- Always disconnect the Z4/Z8 from the power supply by pulling on the plug, not the cord.
- Allow only an AKAI professional dealer or qualified professional engineer to repair or reassemble the Z4/Z8. Apart from voiding the warranty, unauthorized engineers might touch live internal parts and receive a serious electrical shock. There are no user serviceable parts inside.
- Do not put, or allow anyone to put any object, especially metal objects, into the Z4/Z8.
- Use only a household AC power supply. Never use a DC power supply.
- If water or any other liquid is spilled into or onto the Z4/Z8, disconnect the power, and call your dealer.
- Make sure that the unit is well-ventilated, and away from direct sunlight.
- To avoid damage to internal circuitry, as well as the external finish, keep the Z4/Z8 away from sources of direct heat (stoves, radiators, etc.).
- Avoid using aerosol insecticides, etc. near the Z4/Z8. They may damage the surface, and may ignite.
- Do not use denatured alcohol, thinner or similar chemicals to clean the Z4/Z8. They will damage the finish.
- Modification of this equipment is dangerous, and can result in the functions of the Z4/Z8 being impaired. Never attempt to modify the equipment in any way.
- Make sure that the Z4/Z8 is always well-supported when in use (either in a specially-designed equipment rack, or on a firm level surface).
- When installing the Z4/Z8 in a 19" rack system, always allow 1U of ventilated free space above it to allow for cooling. Make sure that the back of the rack is unobstructed to allow a clear airflow.
- In order to assure optimum performance of your Z4/Z8, select the setup location carefully, and make sure the equipment is used properly. Avoid setting up the Z4/Z8 in the following locations:
 1. In a humid or dusty environment
 2. In a room with poor ventilation
 3. On a surface which is not horizontal
 4. Inside a vehicle such as a car, where it will be subject to vibration
 5. In an extremely hot or cold environment

For U.K. customers only

WARNING
THIS APPARATUS MUST BE EARTHED
IMPORTANT

This equipment is fitted with an approved non-rewireable UK mains plug.

To change the fuse in this type of plug proceed as follows:

- 1) Remove the fuse cover and old fuse.
- 2) Fit a new fuse which should be a BS1362 5 Amp A.S.T.A or BSI approved type.
- 3) Refit the fuse cover.

If the AC mains plug fitted to the lead supplied with this equipment is not suitable for your type of AC outlet sockets, it should be changed to an AC mains lead, complete with moulded plug, to the appropriate type. If this is not possible, the plug should be cut off and a correct one fitted to suit the AC outlet. This should be fused at 5 Amps.

If a plug without a fuse is used, the fuse at the distribution board should NOT BE GREATER than 5 Amp.

PLEASE NOTE: THE SEVERED PLUG MUST BE DESTROYED TO AVOID A POSSIBLE SHOCK HAZARD SHOULD IT BE INSERTED INTO A 13 AMP SOCKET ELSEWHERE.

The wires in this mains lead are coloured in accordance with the following code:

GREEN and YELLOW	— Earth
BLUE	— Neutral
BROWN	— Live

As the colours of the wires in the mains lead of this apparatus may not correspond with the coloured markings identifying the terminals in your plug, please proceed as follows:

The wire which is coloured GREEN and YELLOW must be connected to the terminal which is marked with the letter E or with the safety earth symbol \perp or coloured GREEN or coloured GREEN and YELLOW.

The wire which is coloured BLUE must be connected to the terminal which is marked with the letter N or coloured BLACK.

The wire which is coloured BROWN must be connected to the terminal which is marked with the letter L or coloured RED.

THIS APPARATUS MUST BE EARTHED

Ensure that all the terminals are securely tightened and no loose strands of wire exist.

Before replacing the plug cover, make certain the cord grip is clamped over the outer sheath of the lead and not simply over the wires.

6D-En

FCC WARNING

This equipment has been tested and found to comply with the limits for a Class B digital device pursuant to Part 15 of the FCC rules. These limits are designed to provide reasonable protection against harmful interference in a residential installation. This equipment generates, uses, and can radiate radio frequency energy and, if not installed and used in accordance with the instructions, may cause harmful interference to radio communications. However, there is no guarantee that interference will not occur in a particular installation. If this equipment does cause harmful interference to radio or television reception, which can be determined by turning the equipment off and on, the user is encouraged to try to correct the interference by one or more of the following measures:

- Reorient or relocate the receiving antenna.
- Increase the separation between the equipment and receiver.
- Connect the equipment into an outlet on a circuit different from that to which the receiver is connected.
- Consult the dealer or an experienced radio/TV technician for help.

21B-En

AVIS POUR LES ACHETEURS CANADIENS DU Z4/Z8

Le présent appareil numérique n'émet pas de bruits radioélectriques dépassant les limites applicables aux appareils numériques de la Class B prescrites dans le Règlement sur le brouillage radioélectrique édicté par le ministère des Communications du Canada.

27-F

This digital apparatus does not exceed the Class B limits for radio noise emissions from digital apparatus set out in the Radio Interference Regulations of the Canadian Department of Communications.

27-En

VENTILATION

Do not prevent the unit's ventilation, especially by placing the unit on soft carpet, in a narrow space, or by placing objects on the unit's chassis—top, side, or rear panels. Always keep the unit's chassis at least 10 centimeters from any other objects.

31C-En

CHANGES OR MODIFICATIONS NOT EXPRESSLY APPROVED BY THE MANUFACTURER FOR COMPLIANCE COULD VOID THE USER'S AUTHORITY TO OPERATE THE EQUIPMENT.

32-En

COPYRIGHT NOTICE

The AKAI professional Z4/Z8 is a computer-based device, and as such contains and uses software in ROMs. This software, and all related documentation, including this Operator's Manual, contain proprietary information which is protected by copyright laws. All rights are reserved. No part of the software or its documentation may be copied, transferred or modified. You may not modify, adapt, translate, lease, distribute, resell for profit or create derivative works based on the software and its related documentation or any part thereof without prior written consent from AKAI professional M.I. Corp., Yokohama, Japan.

Contents

1 Introduction	1
Features	1
Architecture	2
2 Front & Rear Panels	6
Front Panel	6
Rear Panel	9
3 Getting Started	11
Installation	11
Hookup Example	11
Connecting USB Devices	12
Connecting SCSI Devices	12
Detaching the Removable Panel (Z8 only)	13
Connecting the Power Cord	13
Switching On & Off	13
Navigating the User Interface	14
Using the PLAY Button	15
Using the Clipboard	16
Entering Names	17
4 Loading	18
Loading	18
Sound Library CD-ROM	19
5 Recording Samples	22
Sampling	22
Adding New Samples to Programs	25
Auto Sampling	26
Sampling with Q-FX	27
6 Editing Samples	29
About Sample Editing	29
Selecting Samples for Editing	29
Tagging Samples	30
Selecting a Monitoring Item	30
Trimming Samples	30
Viewing the Waveform	31
Zooming Samples	31
Special Sample Playback for Auditioning	31
Setting the Start Point	32
Setting the End Point	32
Sample Edit	33
Resampling with Q-FX	38
Setting Loops	40
Setting and Fine-tuning the Loop Start & End Points	41
Auto Loop Find Functions	42

Crossfading Loops	42
Setting Regions	43
Adjusting Region Start & End Points	43
Slicing Regions	44
BPM Tempo Matching	45
Renaming Samples	46
Copying Samples	46
Deleting Samples	47
Adding Samples to Programs	47
7 Using Programs	48
About Program Mode	48
Selecting Programs	48
Configuring Programs	49
Creating Keygroup Programs	50
Configuring Keygroup Programs	51
Creating Drum Programs	56
Configuring Drum Programs	57
Configuring Program Modulation	58
Renaming, Deleting, Copying, Merging, Purging & Converting Programs	60
Configuring Program MIDI Options	61
Configuring Pitch Bend	62
Configuring the LFOs	63
Configuring the Filters	64
Configuring the Amp, Filter & Aux Envelopes	65
8 Using Multis	67
About Multi Mode	67
Selecting Multis	67
Creating Multis	68
Assigning Programs to Parts	69
Filtering MIDI Data	71
Applying FX to Parts	72
Copying Multis	72
Deleting Multis	73
Playing Songs	74
9 Using Q-Link	75
About Q-Link	75
Configuring Q-Link	75
10 Using FX	78
About the FX	78
Configuring FX Inputs	78
Configuring FX Outputs	79
Selecting FX Types	79
Linking FX	80
Setting the FX Level	81
Editing FX	81
FX Types	82

11 Saving	84
Saving	84
12 Disk & File Utilities	87
Deleting Files & Folders	87
Formatting Disks	88
13 General Utilities	89
Setting the Master Level, Tuning, SCSI ID & MIDI OUT/THRU	89
Setting the Display Contrast, Note Display, Date & Time	89
Setting the System Clock & Digital Out Sync	90
Monitoring MIDI Activity	91
Initializing the Z8	91
Erasing Entire Memory	92
Testing Memory	92
Defragmenting the Memory Space	92
Appendix	93
Specifications	93
Index	94

1 Introduction

Thank you for choosing an AKAI Professional sampler.

This User Guide uses the model name “Z8” to cover both the AKAI Professional Z8 and Z4. Unless otherwise stated, information applies to both models.

Features

- Removable front panel allows remote operation (Z8 only)
- WAV support provides compatibility with numerous sound libraries
- Assignable Q-Link controls for real-time Program and FX control
- Versatile sample editing includes Loop, Time Stretch, Pitch Shift, Normalize, Join, Fade, Delete Section, Reverse, and Tempo Match, etc.
- 64-voice polyphonic, 128-part multitimbral (32-voice polyphonic with the system clock set to 96kHz)
- Drum-type Programs specifically for use with drum and phrase Samples
- Playback SMF (Standard MIDI File) songs in Multi mode
- 192 two-pole resonant filters, up to three simultaneous filters per voice, 35 filter types by combination of three filters
- Two independent LFOs
- 4 multi-effects processors (Z4 requires EB4JS option)
- Sample and resample with FX (QuickFX)
- Supports 16/24-bit, 44.1/48/96 kHz sampling (32-voice polyphonic with the system clock set to 96kHz)
- 24-bit/96 kHz ADC/DAC, with Enhanced Dual Bit 64-times oversampling ADC and Advanced Multi-bit 128-times oversampling DAC
- Balanced analog I/O
- S/PDIF format digital I/O (Z4 requires IB-4D option)
- Built-in sample rate converters enable you to input and output digital signals easily without considering the difference in sampling rates between the devices. (Q-Link Digital Connection)
- Wordclock input for synchronizing the digital output signals to external devices
- Memory expandable up to 512 MB
- 32-channel multi-port MIDI interface (MIDI IN x2, OUT/THRU x2)
- SCSI port for connecting hard disks and removable media drives
- USB slave port for connecting a Mac/PC running the AKAI Professional ak.Sys software
- USB master port for connecting USB floppy disk drives, hard disks, removable media drives, or a USB keyboard for quick name entry
- Internal 3.5-inch drive bay for ATA hard disk or removable media drive
- Supports DOS FAT16/FAT32 disk formats for PC compatibility
- Hierarchical filing system uses folders to organize files
- Flash ROM programmable operating system
- Optional 2-in/8-out ADAT board (IB-4ADT)
- Optional 8 individual analog output board (IB-48P)

Note: An optional ADAT card (IB-4ADT) and an Individual Analog Output card (IB-4P) cannot be installed at the same time.

Note: The Z8 Samplers contain no user serviceable parts. Please consult your AKAI Professional dealer regarding the installation of options and upgrades.

Architecture

This chapter explains how sounds are constructed in the Z8 and the hierarchic relationship between Samples, Programs, and Multis, in which Samples, the sound building blocks, are assigned to Programs, and Programs are assigned to Multis. It also introduces many of the terms used throughout this *User Guide*.

Samples

Samples are the sound building blocks used to create Programs and Multis. Samples can be recorded in Record mode, or loaded from disk. See “Recording Samples” on page 22 for more information on recording samples. Also, see “Loading” on page 18 for more information on loading samples from disk.

Samples can be edited in Sample mode. See “Editing Samples” on page 29 for more information.

Programs

A Program is, by analogy, a musical instrument, and consists of one or multiple samples that have been processed via filter, envelope, LFO, and other parameters. It could be a piano sound made of few samples that cover different ranges from high to low. Or, it could be a drum kit containing a snare, bass drum, and cymbal samples. There are two types of Programs: Keygroup and Drum. You can use these types to create different sounds.

Keygroup Programs consist of one or multiple Keygroups, which is somewhat like containers of Samples. In Keygroups, a Sample can be assigned to a group of adjacent notes, called a Keyspan. You can also specify the range of a Keyspan. Keygroup Programs are often used for sounds that are played in scales on a keyboard, such as a piano. You can assign up to four Samples to a Keygroup, and play multiple Samples simultaneously, or play different Samples by changing the velocity (how hard you play the keys) (Zone function).

Each Keygroup features various editing parameters, such as a filter and an envelope, which enable you to make detailed adjustments to the sounds.

The following example illustrates the most basic Program configuration, with one Sample assigned to one Keygroup and a Keyspan that covers the entire keyboard.

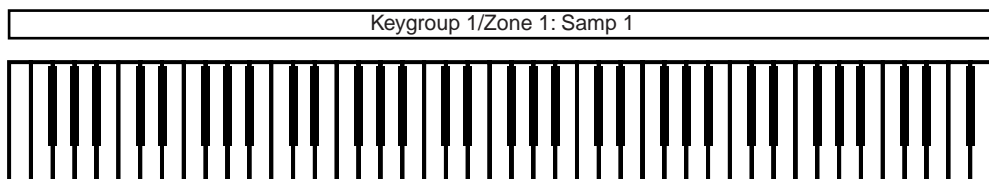

The following Program consists of four Keygroups, each with its own Keyspan, and one Sample assigned to each Keygroup.

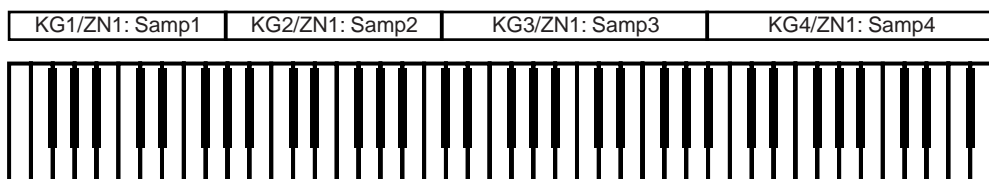

The following Program consists of two Keygroups with overlapping Keyspans. Crossfade can be applied to the overlapping parts.

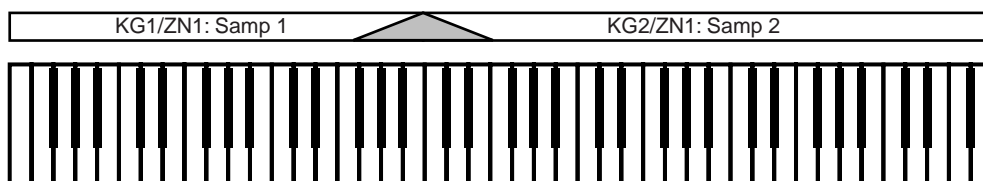

The following Program consists of three Keygroups: one that spans the entire keyboard, and two with overlapping Keyspans and a crossfade.

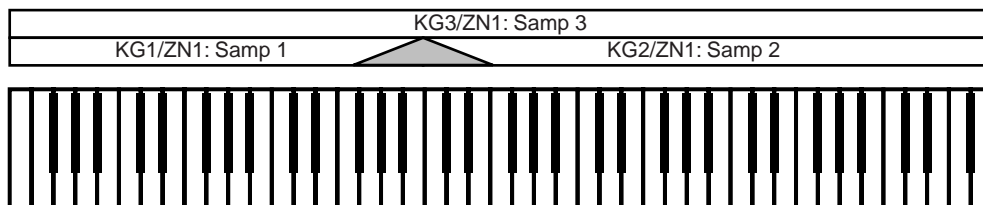

The following Program consists of two Keygroups. One Sample is assigned to each of four Zones within each Keygroup. via the Zone function.

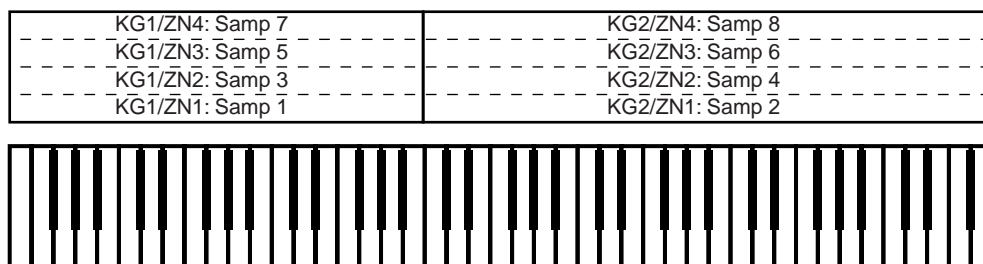

The following Program consists of three Keygroups: one that spans the entire keyboard with three Samples assigned, and two overlapping Keygroups with four Samples assigned.

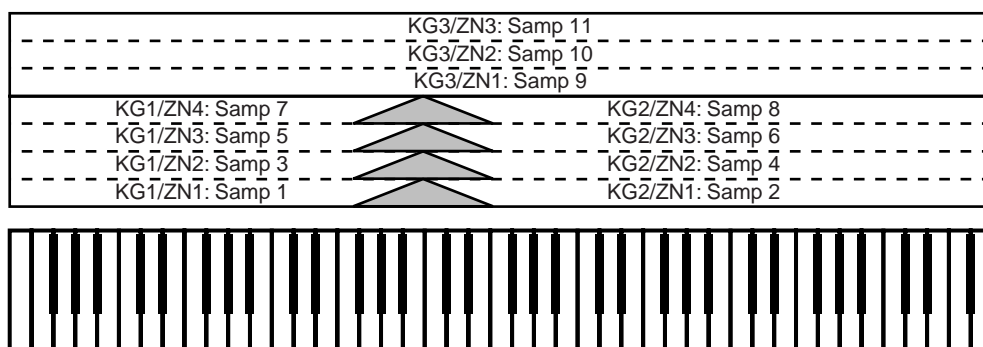

Drum Programs are intended for use with drum and phrase Samples. The main difference from Keygroup Programs is that each drum Sample is assigned to a single note number instead of a Keygroup. Drum Programs are not used to play different tunes (in scales) on the keyboard, unlike Keygroup Programs. Rather, they are useful when you want the different notes to play different sounds, such as drum and phrase Samples. Otherwise, Drum Programs are almost identical to Keygroup Programs.

The following example illustrates a basic Drum Program, with one Sample assigned to each note.

Zone 1: Kick1
Zone 1: Kick2
Zone 1: Snar
Zone 1: O.Hat
Zone 1: C.Hat
Zone 1: Tom1
Zone 1: Tom2
Zone 1: Tom3
Zone 1:

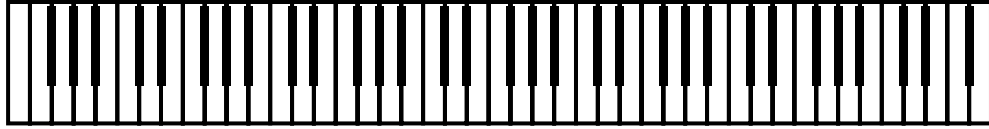

The following Drum Program uses Zones #1 and #2 to layer drum Samples, with velocity crossfades on certain notes.

Zone 1: Kick1	Zone 2: Thud
Zone 1: Kick2	Zone 2: Boom
Zone 1: Snar	Zone 2: Clap
Zone 1: O.Hat	Zone 2: Tish
Zone 1: C.Hat	Zone 2: Click
Zone 1: Tom1	Zone 2: Tom4
Zone 1: Tom2	Zone 2: Tom5
Zone 1: Tom3	Zone 2: Tom6
Zone 1:	Zone 2:

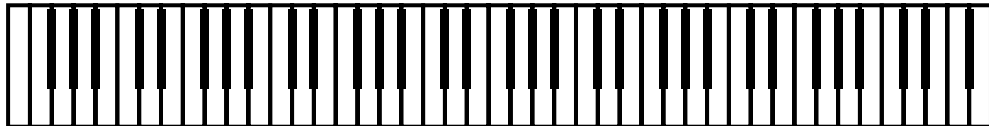

Each Keygroup of the Keygroup Programs and each note of the Drum Programs have independent parameters that include basic parameters, such as level, pan, tuning, etc. Combining these parameters with the Z8's filters, envelope shapers, and LFOs enables you to perform advanced sound editing.

See "Using Programs" on page 48 for detailed information on creating and editing Programs.

Multis

To play Programs, you need to make various settings in Multis. A Multi is constructed from one or multiple Parts. Each Part provides independent level, pan, MIDI Channel, and other settings required for playing the Z8 via MIDI keyboards or external MIDI devices. You can play Programs when they are assigned to Parts. You can use MIDI Program Change messages to select Programs for Parts inside a Multi, and to select a Multi as a voice or sound from several Multis.

When you use Multis, you can use the Q-Link controls to adjust tonal color in real time. See “Using Q-Link” on page 75 for more information.

FX

The Z8 features four 24-bit/96 kHz multi-effects processors (Z4 requires EB4JS option), offering a whole host of FX types, including reverbs, delays, modulation-based FX, dynamics, wah-wah, and pitch shifting. FX can be applied while sampling (see page 27), re-sampling (see page 38), or in Multi mode. In addition to the various FX types, Quick-FX presets such as Power, Swell, and Crisp provide an intuitive way to apply FX. See “Using FX” on page 78 for information on selecting and editing FX types.

When you use Multis, you can adjust FX parameters via the Q-Link control in real time. See “Using Q-Link” on page 75 for more information.

Loading

Samples, Programs, Multis, Songs, and files can be loaded from hard disks and CD-ROMs. Files can be loaded individually or in groups. See “Loading” on page 18 for more information.

Saving

Individual Samples, Programs, Multis, Songs, and files can be saved to hard disks and removable media drives. Loaded data, recorded Samples, created or edited Programs and Multis are temporarily kept in the memory of the Z8. When the power to the Z8 is turned off, the data in memory will be lost. Be sure to save important data to hard disks or external storage devices. You can load the data saved on an external storage device in Load mode. See “Saving” on page 84 for more information.

2 Front & Rear Panels

Front Panel

Z8 Front Panel

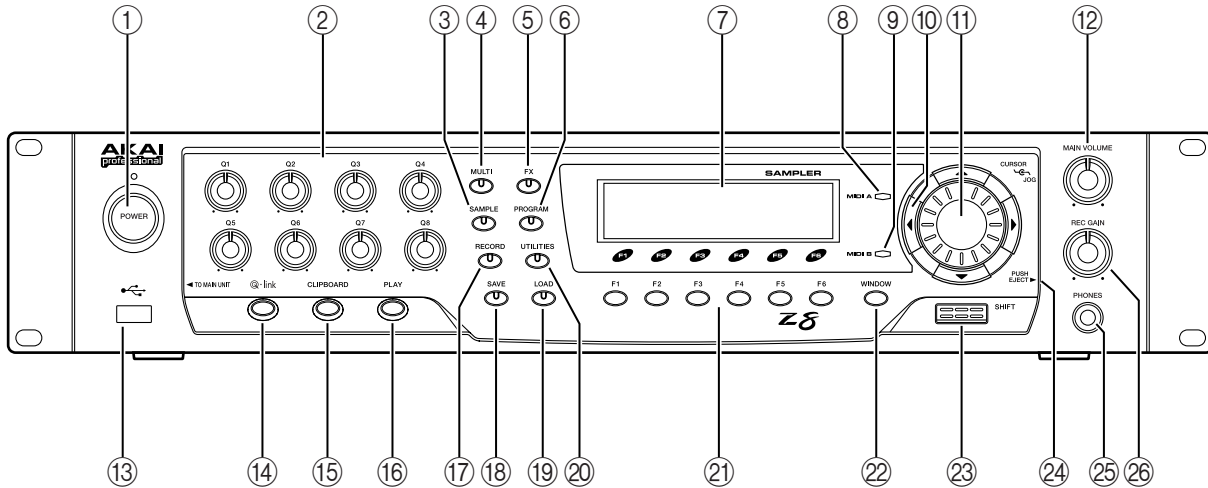

Z4 Front Panel

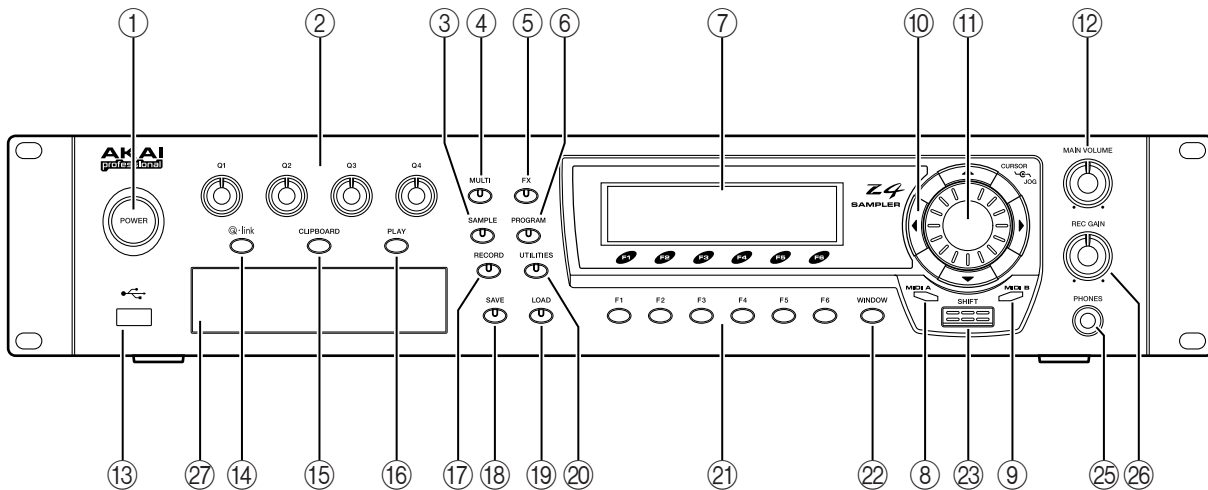

1 POWER switch

This switch is used to turn on and off the power to the Z8. See “Switching On & Off” on page 13 for more information.

2 Q-LINK controls

Up to eight parameters (four on the Z4) can be assigned to these controls for real-time control. See “Using Q-Link” on page 75 for more information.

3 SAMPLE button & indicator

Pressing this button selects Sample Edit mode, which is used to edit Samples. The SAMPLE button indicator lights up when this mode is selected. See “Editing Samples” on page 29 for more information.

4 MULTI button & indicator

Pressing this button selects Multi mode, in which Multis can be selected, edited, and played. The MULTI button indicator lights up when this mode is selected. This mode is typically used when the Z8 is connected to a MIDI keyboard or MIDI sequencer. Standard MIDI Files (SMF) can also be played in this mode. See “Using Multis” on page 67 for more information.

5 FX button & indicator

Pressing this button selects FX mode, which is used to select and edit the four independent FX processors (optional on the Z4). The FX button indicator lights up when this mode is selected. See “Using FX” on page 78 for more information.

6 PROGRAM button & indicator

Pressing this button selects Program mode, in which Programs can be selected, edited, and played. See “Using Programs” on page 48 for more information.

7 Display

This back-lit 248 by 60 dot LCD (liquid crystal display), together with the illuminated panel buttons, displays the current operating state of the Z8. See “Navigating the User Interface” on page 14 for more information.

8 MIDI A activity indicator

This indicator lights up when MIDI data is received at the MIDI IN A port.

9 MIDI B activity indicator

This indicator lights up when MIDI data is received at the MIDI IN B port.

10 CURSOR buttons

These buttons are used to select items (parameter) on the display pages. See “Navigating the User Interface” on page 14 for more information.

11 JOG dial

This dial is used to increment or decrement parameter values. Rotating it clockwise increases values; rotating it counterclockwise decreases them. See “Navigating the User Interface” on page 14 for more information.

12 MAIN VOLUME control

This control is used to set the volume of the MAIN OUT and PHONES.

13 USB port (Host)

Various USB (Universal Serial Bus) devices can be connected here, including floppy disk drives, hard disk drives, CD-ROM, and removable media drives for additional storage, or USB keyboards for quick name entry. See “Connecting USB Devices” on page 12 for more information.

14 Q-LINK SETUP button

This button selects the Q-LINK SETUP page, which is used to assign parameters to the Q-Link controls. See “Using Q-Link” on page 75 for more information.

15 CLIPBOARD button

The Clipboard can be used as a temporary store while editing Samples, Programs, or Multis, allowing A/B comparisons. See “Using the Clipboard” on page 16 for more information.

16 PLAY button

Pressing the PLAY button plays the currently selected Sample or Program. See “Using the PLAY Button” on page 15 for more information.

17 RECORD button & indicator

Pressing this button selects Record mode, which will light up its indicator. This mode is for sampling sounds. See “Recording Samples” on page 22 for more information.

18 SAVE button & indicator

Pressing this button selects Save mode, which is used to save Samples, Programs, Multis, Songs, and files. The SAVE button indicator lights up when this mode is selected. See “Saving” on page 84 for more information.

19 LOAD button & indicator

Pressing this button selects Load mode, which is used to load Samples, Programs, Multis, Songs, and files. The LOAD button indicator lights up when this mode is selected. See “Loading” on page 18 for more information.

20 UTILITIES button & indicator

Pressing this button selects Utilities mode, which contains various global functions. See “General Utilities” on page 89 for more information.

21 Function buttons F1 to F6

The functions of these buttons change depending on the selected display page. Each button corresponds to a function on the display. See “Navigating the User Interface” on page 14 for more information.

22 WINDOW button

The WINDOW button is used to open and close display windows. See “Navigating the User Interface” on page 14 for more information.

23 SHIFT button

This button is used as a short cut to special functions, in conjunction with other buttons.

24 Removable Panel release button (Z8 only)

Pressing this button releases the Removable Panel for remote operation of the unit. Removing this panel also allows access to the 3.5" drive bay. See “Detaching the Removable Panel (Z8 only)” on page 13 for more information.

25 PHONES jack

This 1/4-inch (6.3 mm) stereo phone jack outputs the headphone signal, which is the same as the MAIN OUT signal.

26 REC GAIN control

This control is used to set the recording level. See “Sampling” on page 22 for more information.

27 Front Panel 3.5" Drive Bay (Z4 only)

This 3.5" Drive Bay is a mounting for additional storage devices.

View of 3.5" Drive Bay (Z8 only)

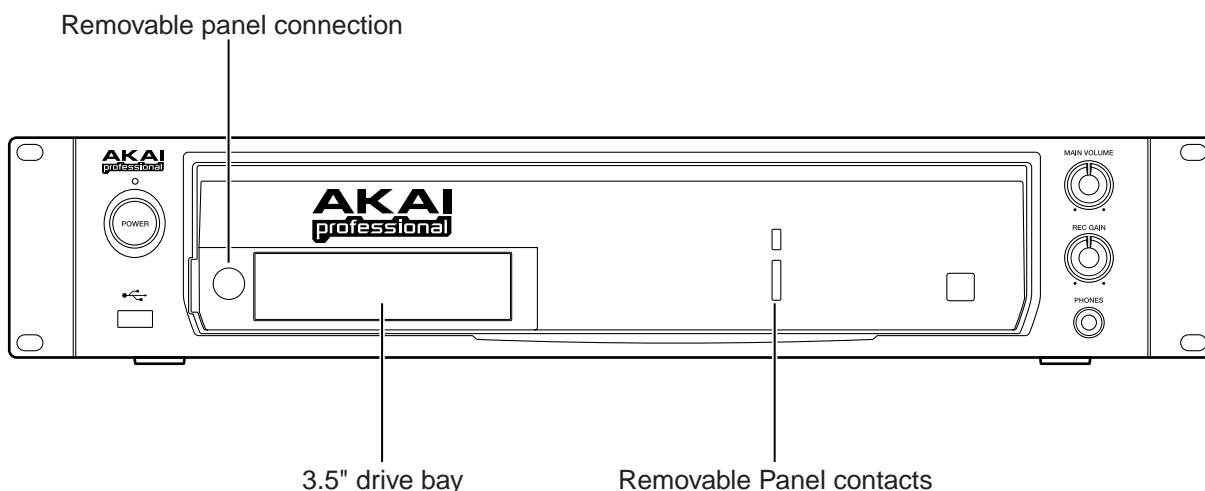

To protect the Removable Panel contacts against corrosion, and to avoid accidentally shorting them, always fit the supplied Contact Cover when the Removable Panel is detached.

Rear Panel

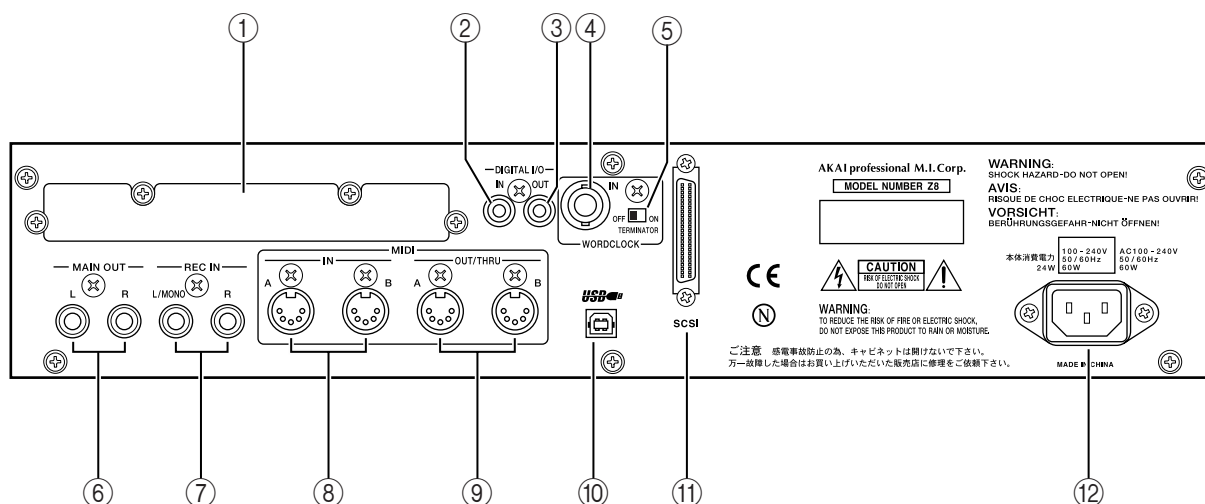
**1 Option slot**

This slot is for installing optional interface cards.

2 DIGITAL I/O IN (optional on Z4)

This phono connector is used to input S/PDIF format digital audio signals, typically from CD players, DAT decks, or any audio device with S/PDIF format digital I/O. See “Sampling” on page 22 for more information.

3 DIGITAL I/O OUT (optional on Z4)

This phono connector is used to output the MAIN OUT signals as S/PDIF format digital audio.

4 WORDCLOCK IN (optional on Z4)

This BNC connector is used to receive external wordclock signals.

5 Wordclock TERMINATOR switch (optional on Z4)

This switch is used to terminate the external wordclock signal connected to the WORDCLOCK IN.

6 MAIN OUT

These two 1/4-inch balanced phone jacks are the main analog audio outputs. They are wired as follows: tip = hot, ring = cold, sleeve = ground.

7 REC IN

These two 1/4-inch balanced phone jacks are used to input analog audio signals and are wired as follows: tip = hot, ring = cold, sleeve = ground. See “Sampling” on page 22 for more information.

8 MIDI IN x 2

The Z8’s two MIDI IN ports support 32 MIDI channels, referred to as 1A to 16A (MIDI IN A) and 1B to 16B (MIDI IN B). See “Assigning Programs to Parts” on page 69 for more information.

9 MIDI OUT/THRU x 2

These MIDI ports transmit MIDI data received at the respective MIDI IN port (A or B). MIDI Song data can also be transmitted. See “General Utilities” on page 89 for more information.

10 USB port (Slave)

This USB port is used to connect the Z8 to a PC or Mac for use with AKAI professional Akai ak.Sys software, which allows file transfer between the Z8 and the computer, and remote editing of Programs and Multis. See “Connecting USB Devices” on page 12 for more information.

11 SCSI port

This is a 50-way SCSI connector that supports the SCSI standard. It can be used to connect additional storage devices, including hard disk, CD-ROM drives, and removable media drives. See “Connecting SCSI Devices” on page 12 for more information.

12 AC inlet

The supplied AC power cord is connected here. See “Getting Started” on page 11 for more information.

3 Getting Started

This chapter explains how to get the Z8 up and running, including connecting, switching on, navigating the user interface, and some operating basics.

Installation

If the Z8 is rack mounted, 5 cm of space should be left above and below it to provide adequate ventilation. Do not mount the Z8 directly above equipment that produces a lot of heat, such as a power amplifier. If the Z8 is to be free standing, ensure that it is placed on a sturdy, level surface, and that its ventilation grilles are not obstructed.

Hookup Example

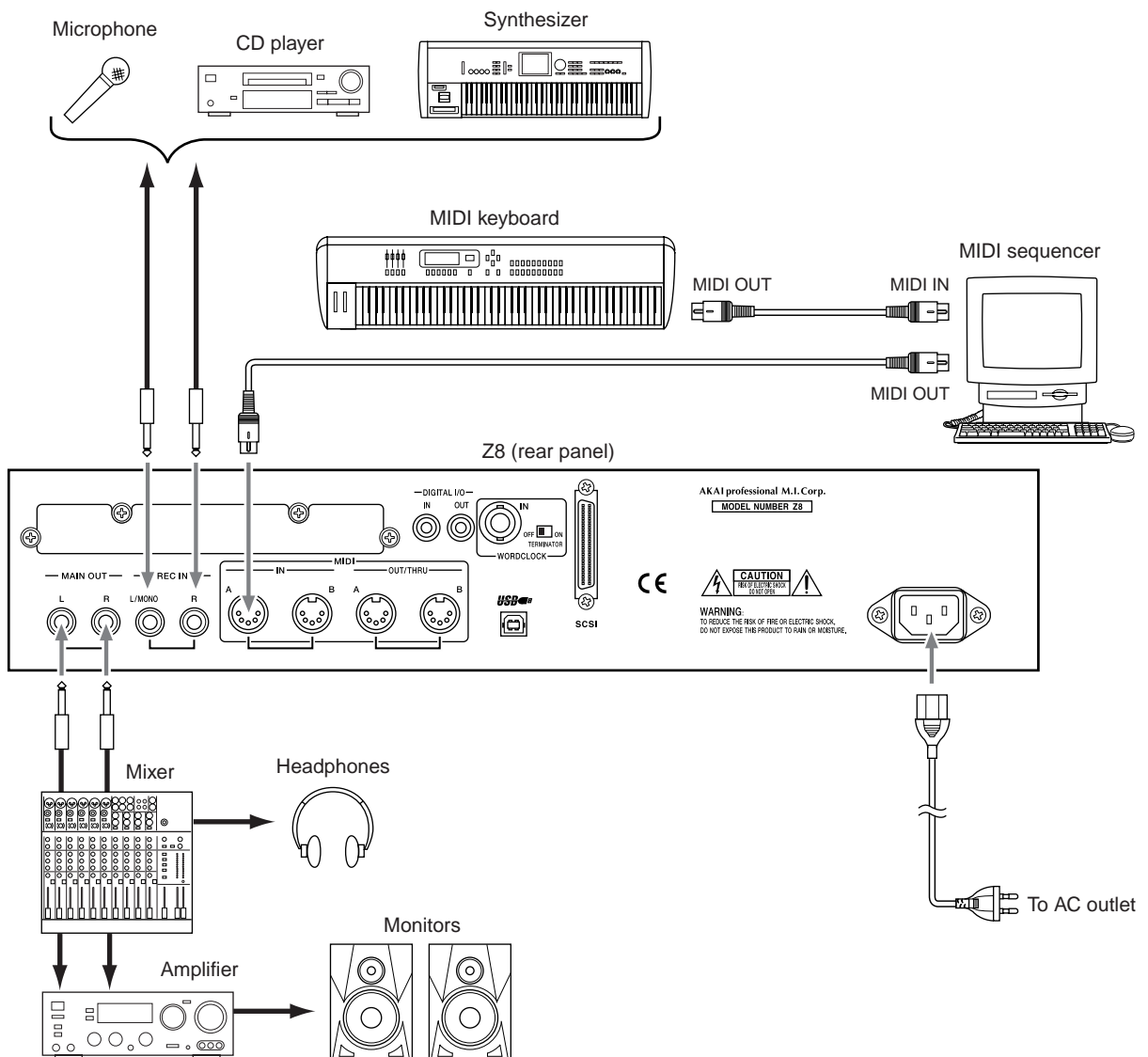

Connecting USB Devices

There are two USB ports on the Z8. The rear panel (slave) port is for connection to a PC or Mac equipped with a USB port, for remote operation of the Z8 using Akai professional ak.Sys software. The front panel (host) port is for connecting USB storage devices, such as floppy disk drives, hard disks, CD-ROM drives, and removable media drives. A USB keyboard can also be connected for quick name entry.

The USB ports are “hot-pluggable,” which means devices can be connected or disconnected even while the Z8 is on. Supported devices are recognized automatically. If a device is not supported, the Z8 simply ignores it.

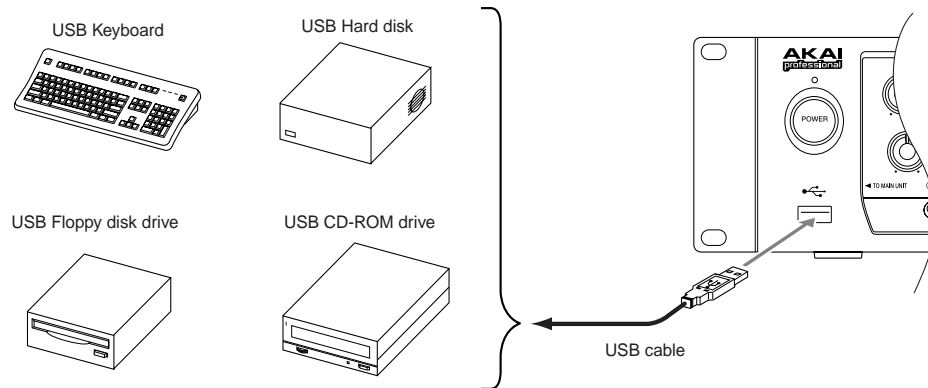

Connecting SCSI Devices

The Z8 features a SCSI port on the rear panel for connecting SCSI storage devices, including hard disks and removable media drives.

The Z8 and your SCSI devices must be switched off before they are connected. Up to seven SCSI devices, each with its own unique SCSI ID, can be connected to the Z8. The last device on the bus must be terminated correctly. See your SCSI device’s manual for details.

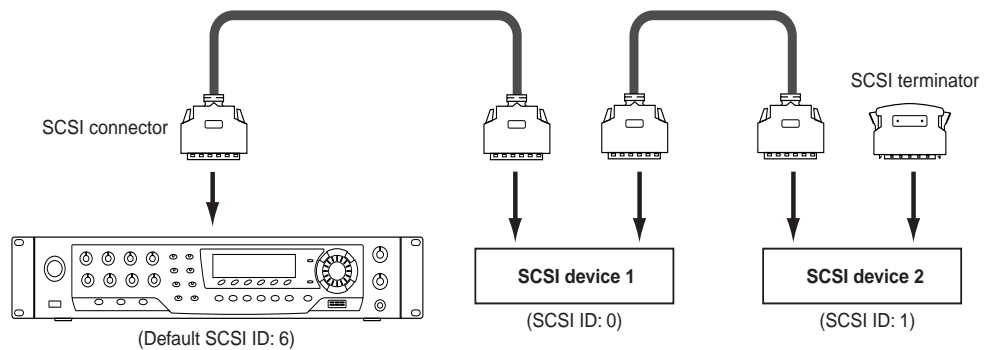

Note: Never assign an external SCSI device to the same SCSI ID as that of the Z8.

See page 89 for information on setting the Z8 SCSI ID (The factory default ID number is “6”). Occasionally, depending on the type and number of SCSI devices connected to the bus, you may find that errors occur when trying to access devices, or there are problems operating the Z8. In this case, try the following:

- Ensure that no two devices have the same SCSI ID.
- Disconnect or disable the terminator, or change the order of the connected devices.
- Check the SCSI cables. Use the highest quality shielded cables you can find, and choose the shortest practical length.

For information on the drives that can be used with the Z8, please contact your Akai dealer or Akai Professional M.I. Service Department.

Detaching the Removable Panel (Z8 only)

The Z8 features a Removable Panel for remote operation.

Note: Do not attach or detach the Removable Panel while the Z8 is on.

- 1 While pressing the release button, push the Removable Panel to the right in order to release it from the main unit.
- 2 Connect the supplied connecting cable between the removable panel and the Z8, as shown below.

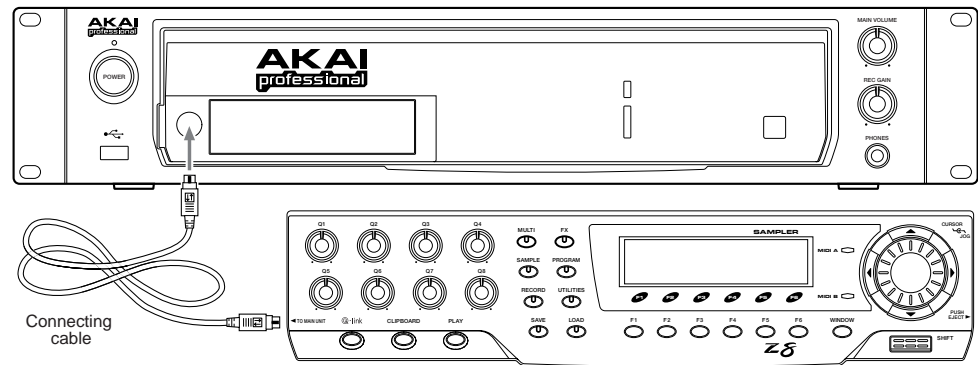

Before reattaching the Removable Panel, switch off the Z8, and disconnect the connecting cable. Fit the Removable Panel into the recessed bay of the main unit and push it to the left until it locks into place.

Note: To avoid accidentally shorting the contact pins on the main unit, always fit the supplied Contact Cover when the Removable Panel is detached.

Connecting the Power Cord

Connect the supplied power cord to the AC inlet socket on the rear panel of the Z8, and connect the other end to a suitable AC wall outlet that conforms to the power requirements stated on the Z8 rear panel.

Switching On & Off

To help protect your loudspeakers (and your hearing) from switch-on clicks and thumps, switch on the Z8 and any other sound sources first. Monitor amps should always be switched on last. Reverse this sequence when switching off your equipment.

- 1 Press the **POWER** switch to switch on the Z8.

The Startup page appears, as shown below.



The Z8 takes a few seconds to start up.

- 2 Press the **POWER** switch again to switch off the Z8.

Navigating the User Interface

This section explains how to find your way around the Z8.

Pages & Windows

Z8 functions are organized as display pages and windows. Along the bottom of each page or window are the names of additional pages or functions, which can be accessed by pressing the F1 through F6 function buttons located directly below the display. For example, to access the KGRP page from the following page, you'd press F2. To select the ZONE page, you'd press F3, and so on.

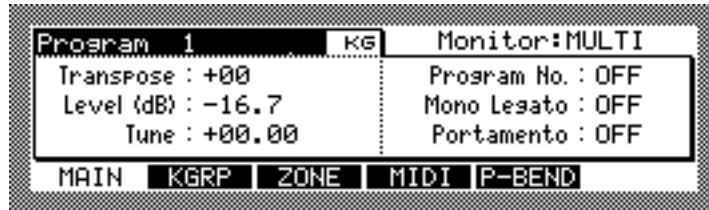

Items that indicate the corresponding information on the display or that can be edited are called “parameter.” Parameters that can be edited display a colon (:) after their name, such as “Level: -16.7” (above). Parameters that cannot be edited but are for display purposes only indicate an equal sign (=) after their name.

You can access windows by pressing the WINDOW button when certain parameters are selected. Pressing the WINDOW button when the Program name is selected on the display shown above, opens the Program window (shown below).



Windows close and the previous display screens are restored when you press the WINDOW button again, or by pressing “CLOSE” or “CANCEL” (if available). In some parameters, pressing the WINDOW button does not open any windows.

Selecting & Editing Parameters

Parameters are selected for editing by using the CURSOR buttons. The selected parameter appears highlighted, as shown by the “St” parameter below.



For certain parameters, in addition to a value, you can also select the parameter’s name. For example, on the TRIM, LOOP, or REGION page, the “End” parameter name, shown below, is used to set the End parameter display format.



Use the JOG dial to edit parameter values.

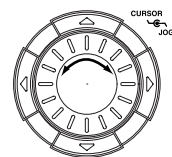

To select the digits in the numeric parameters, for example, during Sample editing, press and hold the SHIFT button, then use the CURSOR Left and Right buttons.

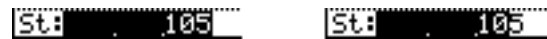

Use the JOG dial to change the value of the selected digits. In this example, the illustration on the left indicates that you can change the value of the units digit (i.e., the right-most digit). When you press the CURSOR left button while holding down the SHIFT button, the tens digit is selected (as shown in the illustration on the right) enabling you to change the value.

Using the PLAY Button

Samples, Programs, or Multis can be auditioned by pressing the PLAY button even when a MIDI keyboard is not connected. A Note On message is generated when the PLAY button is pressed, and a Note Off message, when it's released.

You can specify which Note is generated, its velocity, and MIDI Channel as follows.

1 While holding down the PLAY button, press the WINDOW button.

The PLAY window appears, as shown below.



2 Select the parameters, and use the JOG dial to set them as required.

Note: This determines the note that is generated when the PLAY button is pressed. If you hold down the PLAY button while changing this value, a new Note On message is generated as each note is selected. This is convenient for checking the transitions between Keygroups, and for checking what Samples are assigned to notes in a Drum Program. This technique can also be used while holding notes (i.e., press the SHIFT button while holding down the PLAY button).

Velocity: (0–127) This determines the velocity of the note generated when the PLAY button is pressed. If you hold down the PLAY button while changing this parameter, a new Note On message with the specified velocity is generated each time the value is changed. This is convenient for checking Programs with velocity switching between Samples.

MIDI channel: (1A–16A, 1B–16B) This determines the MIDI Channel used to transmit the generated note.

Echo to Midi Out: (On, Off) This determines whether or not a Note On message is output when the PLAY button is pressed. With the On setting, the note information is output from MIDI OUT when you press the PLAY button.

3 Press "CLOSE."

Using the Clipboard

Samples, Programs, and Multis can be stored temporarily in the Clipboard. By copying a Sample, Program, or Multi to the Clipboard before editing, you can use the Clipboard to compare your edits with the original. The Clipboard can also be used as an Undo function. There are separate Clipboards for Samples, Programs, and Multis.

- 1 **To copy a Sample, Program, or Multi, to the Clipboard, select the desired Sample, Program, or Multi, then press the CLIPBOARD button.**

The Clipboard window appears, as shown below.

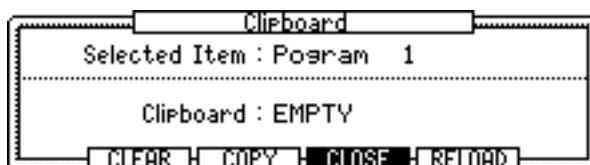

The selected item appears in the Selected Item parameter, and the item currently stored in the Clipboard appears in the Clipboard parameter.

- 2 **Press “COPY” to copy the current Sample, Program, or Multi to the Clipboard.**

The name of the item in the Clipboard appears at the top of the window. While the Clipboard window is open, you can play the Sample, Program, or Multi in the Clipboard by pressing the PLAY button, or by pressing a key on a connected MIDI keyboard. When the Clipboard window is closed, you can play the current Sample, Program, or Multi, allowing you to compare it with the Clipboard contents.

- 3 **To load the Clipboard Sample, Program, or Multi back into memory, overwriting the Sample, Program, or Multi with the same name, press “RELOAD.”**

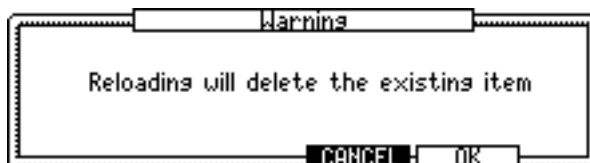

The Warning window appears.

This works just like an Undo function. If the original Sample, Program, or Multi cannot be found (e.g., it's been deleted or renamed), the Clipboard item is copied into memory as a new Sample, Program, or Multi.

- 4 **Press “OK” to load.**

This works just like an Undo function. If the original Sample, Program, or Multi cannot be found (e.g., it's been deleted or renamed), the Clipboard item is copied into memory as a new Sample, Program, or Multi.

- 5 **To erase the contents of the Clipboard, press “CLEAR.”**

Entering Names

Samples, Programs, Multis files are named and renamed by using the Name window, shown below, which appears when the JOG dial is rotated while a nameable parameter is selected. Names can be up to 16 characters long, including spaces.



Use the Left and Right CURSOR buttons to move the CURSOR within the name. Use the Up and Down CURSOR buttons to select uppercase and lowercase characters respectively. To enter a space, while holding down the SHIFT button, press the Right CURSOR button. To delete, while holding down the SHIFT button, press the Left CURSOR button. You can copy and paste the name entry by using the “COPY” and “PASTE” buttons. Press “ENTER” when you have finished. Press “CANCEL” to cancel the Name window. A USB keyboard can be connected to the front panel USB port for quick name entry.

4 Loading

Loading

You can load Samples, Programs, Multis, Songs, and files as follows.

1 Press the LOAD button.

The Z8 enters Load mode, and the following page appears.

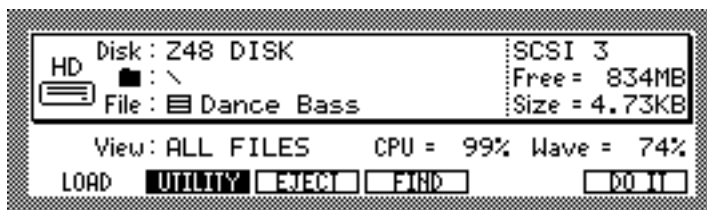

This page displays the amount of free space available on the currently selected disk (“Free=”), the size of the currently selected file (“Size=”), and the amount of free Z8 memory (“Wave=”).

2 Select the “View” parameter, then use the JOG dial to select the type of file that you want to load.

The “View” parameter allows you to filter the file types that can be selected by the File parameter, which is useful when you have many files. For example, if you set the “View” parameter to “SAMPLES,” only Sample files appear at the File parameter. Other options include: ALL FILES, PROGRAMS, MULTIS, FOLDERS, and SONGS.

Note: If a removable storage device is connected, when you want to change the disk, press “EJECT” on the SAVE page, not the eject button on the device. While the device is connected to the Z8, its eject button is disabled.

3 Turn the JOG dial in the “Disk” parameter.

The Disk List window appears.

4 Use the CURSOR buttons to select the desired disk, and press “CLOSE” to close the Disk List window.

The specified disk is selected. See “Saving” on page 84 for more information on the Disk List window.

5 Use the Folder (■) parameter to select the folder that contains the file you wish to load.

If the selected disk does not contain any folders, or if you have selected the root directory (the folder in the upper-most hierarchy), (■) appears in the display. Only files in the selected folder can be selected by the File parameter. The files listed in the File parameter have icons that correspond to the file types.

```

[ ] MID
[ ] MULTI
[ ] PROGRAM
[ ] SAMPLE

```

To move transversely through the folder hierarchy, while holding down the SHIFT button, use the Left and Right CURSOR buttons. To move down through the hierarchy, hold down the SHIFT button, and press the Right CURSOR button. To move up through the hierarchy, hold down the SHIFT button, and press the Left CURSOR button.

6 Press “DO IT” to display the Load Sample, Load Program, Load Multi, or Load Folder window, depending on the selected file.

Tips for selecting a file:

The File Directory window is useful for navigating through the folder hierarchy and selecting files. To open the File Directory window, press the WINDOW button in the Folder parameter or File parameter.



The file directories (tree) are displayed graphically.

Files are managed hierarchically by the file system, and organized in the tree structure via folders. This system is similar to that often used by common computer operating systems.

In the File Directory window, the left column corresponds to the Folder parameter, and the right column corresponds to the File parameter. The folder selected in the Folder parameter includes the (xxx) icon. In this window, you can also use the Left and Right CURSOR buttons to move transversely through the hierarchy. For example, if you select a folder in the right column (File parameter) and press the Right CURSOR button, the folder you just selected in the File parameter now appears in the left column (Folder parameter), and in the right column, you can select a file from the selected folder.

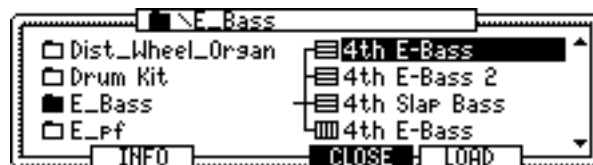

When you close the window by pressing “CLOSE,” the folder selected in the left column appears in the Folder parameter, and the file selected in the right column appears in the File parameter.

To load the selected file, press “LOAD.”

You can search for files by using the Find File window, which you can access by pressing “FIND.” Here you can enter a few characters of a file name, and specify the type of file that you’re trying to find in the File Type parameter. Press “DO IT” to execute searches. Found files appear in the Found Files window. Use the JOG wheel to select a file, then press “LOAD” to load the file.

Sound Library CD-ROM

To load sounds from the included CD-ROM, you will need to connect a CD-ROM drive. Some Programs and Multis on the CD-ROM may require more memory than the standard memory size (16 MB). You will need to expand the memory to load such files. Consult your local dealer or Akai Professional M.I. Service Department regarding the compatible CD-ROM drives and memory expansion.

Loading Samples

If you're loading a Sample, the Load Sample window appears, as shown below.

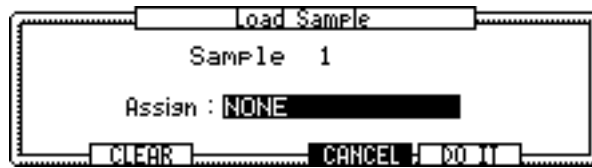

Set the “Assign” parameter as required, and then press “DO IT,” or press “CLEAR” to clear the entire memory before loading.

The “Assign” parameter options are as follows: “NONE” doesn't load the Sample into a Program. “Add to Program” adds the Sample to Program, in which case the Add to Program window appears and you can select an existing Program or create a new Program, and specify the Original Note, Key Range, and Keyboard Tracking parameters. For Drum Programs, you can specify the note that will play the Sample. For information on using the Add to Program window, see “Adding New Samples to Programs” on page 25.

Loading Programs

If you're loading a Program, the Load Program window appears, as shown below.

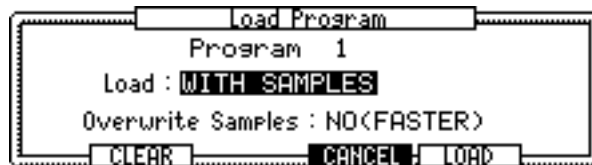

Set the “Load” and “Overwrite Samples” parameters as required, then press “LOAD,” or press “CLEAR” to clear the entire memory before loading.

The “Load” parameter options are as follows: “WITH SAMPLES” loads the Program with its Samples. “PROGRAM ONLY” loads the Program without its Samples.

The “Overwrite Samples” parameter options are as follows: “YES” overwrites Samples with the same name that are already loaded. “NO (FASTER)” loads only the Samples that are not already loaded.

Loading Multis

If you're loading a Multi, the Load Multi window appears, as shown below.

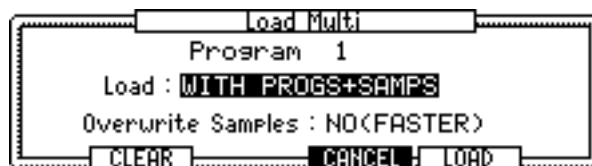

Set the “Load” and “Overwrite Samples” parameters as required, then press “LOAD,” or press “CLEAR” to clear the entire memory before loading.

The “Load” parameter options are as follows: “MULTI ONLY” loads only the Multi. “WITH PROGRAMS” loads the Multi with its Programs. “WITH PROGS+SAMPS” loads the Multi with its Programs and Samples.

The “Overwrite Samples” parameter options are as follows: “YES” overwrites Samples with the same name that are already loaded. “NO (FASTER)” loads only the Samples that are not already loaded.

Loading Folders

If you select a folder in the File parameter and press “DO IT,” the Load Folder window appears, as shown below.



Multiple files in the selected folder can be loaded simultaneously.

Set the “Load” and “Replace same sample” parameters as required, and then press “LOAD,” or press “CLEAR” to clear the entire memory before loading.

The “Load” parameter options are as follows: “SAMPLES” loads all Samples in the specified folder. “PROGS+SAMPLES” loads all Programs and Samples in the specified folder. “MULTIS+PROGS+SAMPLES” loads all Multis, Programs, and Samples in the specified folder. “ALL FILES” loads all files in the specified folder.

The “Replace same sample” parameter options are as follows: “YES” overwrites Samples with the same name that are already loaded. “NO (FASTER)” loads only the Samples that are not already loaded.

In addition to WAV files, the Z8 can load files created for the following instruments:

Manufacturer/Model	File types
AKAI S1000	Sample and Program files
AKAI S3000	Sample and Program files
AKAI S5000 & S6000	Sample, Program, and Multi files
Emu EIII	Sample and Program files

These files can be loaded using the same procedure as for Z8 files.

When Samples that were created for other instruments are loaded, differences may be heard in the sound output. This is due to the different designs and capabilities of the instruments that the sounds were created for. Practical differences arise due to the use of different looping techniques, filter types, the range and types of FX available, and sound output assignments that are not supported.

More file types will be supported in the near future.

5 Recording Samples

This chapter explains how to record Samples, plus Auto Sampling and sampling with FX.

Sampling

You'll need to connect a sound source to the Z8 in order to record. To record from microphones or analog devices, use the REC IN jacks. To record digital signals from CD players or DAT decks, connect to the DIGITAL I/O IN jack. If an optional IB-4ADT interface has been installed, you can also record signals input at the ADAT IN jack.

1 Press the RECORD button.

Its indicator lights up showing that Record mode has been selected, and the following page appears.

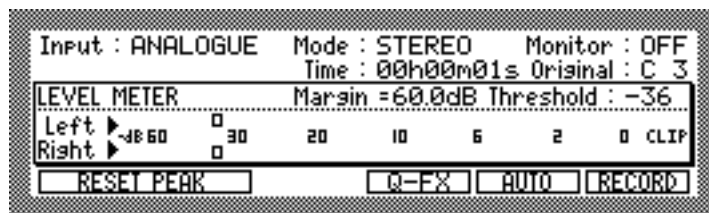

2 Select the “Input” parameter and set the input source to one of the following options:

ANALOGUE: Selects the REC IN as the input source.

DIGITAL: Selects the DIGITAL IN as the input source. (digital inputs are optional on the Z4.)

ADAT (1/2, 3/4, 5/6, 7/8): Selects a pair of ADAT inputs as the input source (requires optional IB-4ADT interface).

MAIN OUT: Selects the Z8's MAIN OUT as the input source, allowing you to record the output from a Multi.

3 Press the WINDOW button to access the “Bit rate,” “Pre-recording time,” and “Auto normalize” parameters.

The Recording Setup window appears. (If the “Time” parameter was selected, the Sample memory window appears instead.)

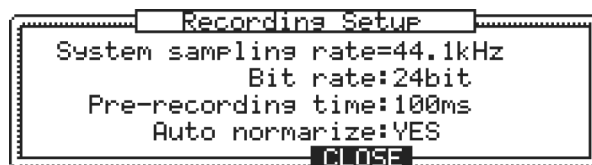

System sampling rate: The system sampling rate can be viewed only here. The sampling rate is set in Utilities mode. See “Setting the System Clock & Digital Out Sync” on page 90 for more information.

Bit-rate: (16 or 24 bit) This sets the bit rate used for recording. Recording in 24-bit offers broader dynamic range, but requires more memory.

Pre-recording: (0–999 ms) This sets the prerecording time, which allows you to start recording up to 999 ms before the point at which recording is actually triggered, or started manually, ensuring that the beginnings of your Samples are captured in full.

Auto normalize: (YES/NO) When Auto normalize is set to YES, the Z8 automatically adjusts the level of the entire Sample to an optimum level after recording.

- 4 Set the Recording Setup options as required, and then press the WINDOW button or “CLOSE” to return to the Record page.
- 5 Select the “Mode” parameter, use the JOG dial to select one of the following:
 - STEREO: Record a stereo Sample using the left (L) and right (R) input signals.
 - MONO L: Record a mono Sample using the left (L) input signal.
 - MONO R: Record a mono Sample using the right (R) input signal.
- 6 Select the “Monitor” parameter, then use the JOG dial to select either:
 - ON: The input source can be monitored via the MAIN OUT and headphones.
 - OFF: The input source is not monitored via the MAIN OUT and headphones.

- 7 While playing the sound source to be recorded, use the REC GAIN control to set the recording level.



Note that the recording level cannot be set when the input source is set to DIGITAL, ADAT, or MAIN OUT in Step 2.

Set the recording level so that the loudest peaks push the LEVEL METER indication across to the far right. If the indication fills the display, or the signal sounds distorted, back off the REC GAIN control. The Peak Hold function is convenient for checking signal peaks, which are indicated by the following indicator(⊗). You can reset the Peak Hold function by pressing “RESET PEAK.”



The “Margin” parameter displays the amount of headroom available before overload.

- 8 Select the “Time” parameter, then use the JOG dial to set the recording time.

The “Time” parameter determines the length of the Sample in hours, minutes, and seconds. Recording stops automatically when the specified recording time has elapsed. Note that you can also stop recording manually by pressing “STOP” before the end of the specified recording time is reached.

- 9 To check the available recording time, select the “Time” parameter, then press the WINDOW button.

The Sample memory window appears.



- 10 Press “CLOSE” to return to the Record page.
- 11 Select the “Original ” parameter.
 - The “Original” parameter sets the note that will play the Sample at its original pitch.
- 12 Select the “Threshold” parameter, then use the JOG dial to set the record start trigger:

0 to -63: Recording starts automatically when the level of the input signal exceeds this threshold. The specified threshold is indicated on the LEVEL METER by the following indicators.

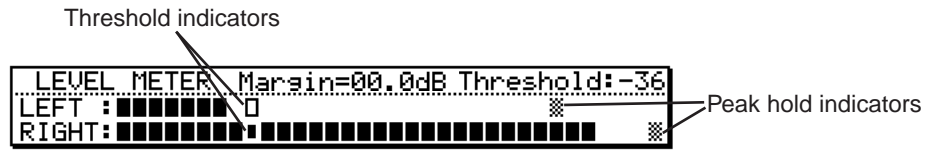

OFF: Recording is started by pressing “RECORD.”

MIDI: Recording starts when a MIDI Note On message is received.

13 Press “RECORD.”

If the “Threshold” parameter is set to OFF, recording starts as soon as “RECORD” is pressed.

If the “Threshold” parameter is set to a value between 0 and -63, the message “Waiting for input signal...” appears, as shown below. Recording starts when the level of the input signal exceeds the specified threshold. You can also start recording manually by pressing “START” or cancel recording by pressing “CANCEL.”

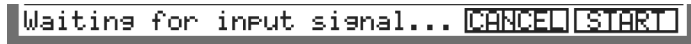

If the “Threshold” parameter is set to MIDI, the message “Waiting for MIDI NOTE...” appears, as shown below. Recording starts when a MIDI Note On message is received (i.e., when you press a key on a connected MIDI keyboard). You can also start recording manually by pressing “START” or cancel recording by pressing “CANCEL.”



While recording is in progress, the progress bar appears, and the message “Recording...” is displayed, as shown below.

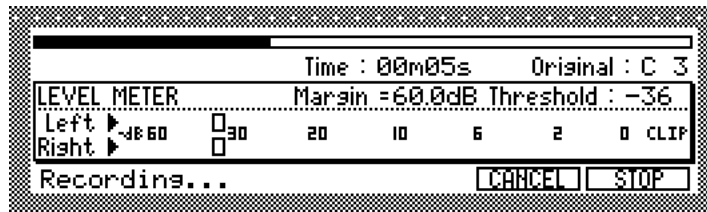

Recording stops automatically when the specified recording time has elapsed.

14 You may press “STOP” to stop recording manually.

If “Auto normalize” in the Recording Setup window is set to “YES,” the Sample is normalized.

The Keep or Retry window appears, as shown below.

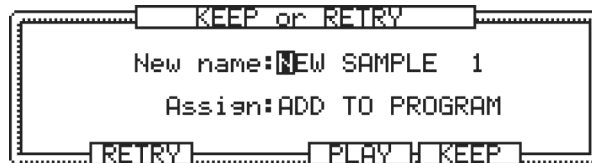

15 Press “PLAY” to play the new Sample.

16 You may press “RETRY” to discard the new Sample and try again.

- 17 To name the Sample, select the “New name” parameter and rotate the JOG dial.

The Name window appears.

See “Entering Names” on page 17 for more information on using the Name window.

- 18 Select the “Assign” parameter, and use the JOG dial to select one of the following:

ADD TO PROGRAM: Adds the new Sample to a Program. See “Adding New Samples to Programs” on page 25 for more information.

NONE: Stores the new Sample in memory, but do not add to a Program.

- 19 If you have set “Assign” to “NONE,” press “KEEP” to keep the Sample in memory.

Adding New Samples to Programs

New Samples can be added to Programs, as follows:

- 1 Follow the Sampling procedure described above, and at step 18, select “ADD TO PROGRAM,” and then press “KEEP.”

The Add to Program window appears.

- 2 Select the “Program” parameter, and use the JOG dial to select the Program to which you want to add the Sample.

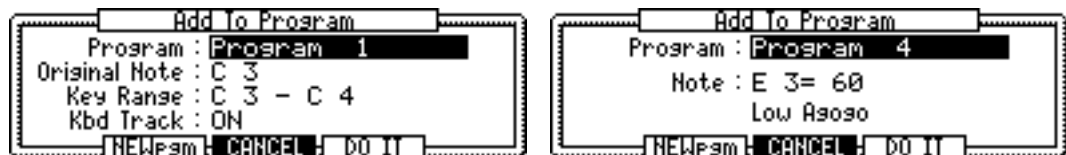

- 3 If you selected a Drum Program, select the “Note” parameter, use the JOG dial to select a note, and then press “DO IT.”

The “Note” parameter determines the MIDI note that will play the Sample.

The Sample is added to the selected Drum Program.

This completes the procedure for adding new Samples to Drum Programs.

- 4 If you selected a Keygroup Program, select the “Original” parameter, and use the JOG dial to select a note.

The “Original” parameter sets the note that will play the Sample at its original pitch.

- 5 Select the “Key range” parameter’s bottom note value, then use the JOG dial to set the bottom note.

The “Key range” parameter has two adjustable values. The left value is the bottom note of the Keygroup range, and the right value is the top note.

- 6 Select the “Key range” parameter’s top note value, then use the JOG dial to set the top note.

- 7 Select the “Kbd track” parameter, then use the JOG dial to select either:

ON: The pitch of Sample playback varies depending on the note played.

OFF: The Sample plays at its original pitch.

8 Press “DO IT.”

The Sample is added to the selected Keygroup Program.

Note: Newly-recorded Samples and created Programs are temporarily stored in the Z8’s memory, but are erased when you turn off the power to the Z8. Be sure to store important Samples and other data to external hard disk or data storage. See “Saving” on page 84 for more information.

Auto Sampling

Auto Sampling allows you to record multiple Samples and add them to a new or existing Program automatically. Auto Sampling starts when the input signal exceeds the specified threshold, and stops when the signal falls below it. When the signal exceeds the threshold again, recording starts again and the next Sample is recorded, and this continues until you stop it. This is useful for sampling from Sample CDs.

- 1 Follow the procedure for “Sampling” on page 22, setting the “Threshold” parameter to a value between 0 and -63, but at step 13, press “AUTO” instead of “RECORD.”**

The Auto Sampling window appears, as shown below.



- 2 Select the “Add to” parameter, then select a Program.**

If you set the “Add to” parameter to “Off,” Auto Sampling will start but Samples will not be added to the Programs.

- 3 Select the “Start key” parameter, then use the JOG dial to select a note.**

The “Start key” parameter determines the key to which the first Sample is assigned. Subsequent Samples are assigned to white keys in ascending order.

- 4 Select the “Sample name” parameter and rotate the JOG dial.**

The Name window appears. See “Entering Names” on page 17 for more information.

The name that you enter here is applied together with a number to each Sample recorded. For example, if you enter the name “METAVIBE,” the first Sample is named “METAVIBE 1,” the second Sample “METAVIBE 2,” and so on.

If you want to create a new Program, press “NEWpgm.”

- 5 Press “DO IT.”**

The message “Waiting for input signal...” appears at the bottom of the page, and “**AUTO SAMPLING**” appears in place of “LEVEL METER.”

- 6 Start the sound source that is to be sampled.**

Recording starts automatically when the level of the input signal exceeds the specified threshold, and the message “Recording...” appears, as shown below. (Recording can also be started by pressing “START.”)

Recording... NEW SAMPLE 1 C_3 [STOP]

Recording stops automatically after the level of the input signal falls below the specified threshold, and the message “Waiting for input signal...” appears, as shown below. (Recording can also be stopped by pressing “STOP.”)



Recording starts and stops automatically each time the input signal exceeds and falls below the specified threshold until you stop it.

7 Press “FINISH” to end Auto Sampling.

Sampling with Q-FX

You can record Samples with FX as follows.

1 On the Record page, press “Q-FX.”

The Quick FX window appears.

2 Select the “Mode” parameter, and use the JOG dial to select a mode.

OFF: No Q-FX.

COMMAND: Use Q-FX, as shown. In this mode you can apply one or two Q-FX while recording mono or stereo Samples.

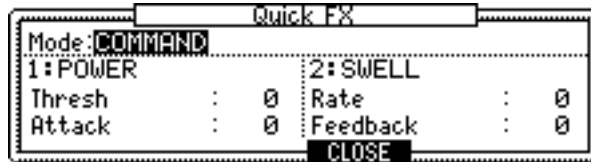

FX: In this mode you can apply up to four FX while recording mono Samples (top window); two when recording stereo Samples (bottom window).



3 If you chose “COMMAND,” select the Q-FX in the “1:” and “2:” parameters.

The following Q-FX are available.

Q-FX	Parameters (-10 to +10)	
POWER	Threshold	Attack
SWELL	Rate	Feedback
DISTORT	Depth	Tone
CRISP	Depth	Tone
GROW DRUM	Tune	Depth
MASSIVE DR	Tune	Depth
WHIRL	Rate	Feedback
DISTANCE	Wide	Shape
COSMO	Rate	Depth
RUMBL	Time	Depth
ROBOT	Delay	Depth
UNDERSEA	Rate	Depth

4 If you chose “FX,” use the JOG dial to select the FX and set the “Wet | Dry” and “Effect” parameters, or press “EDIT” to edit the selected FX processor.

See “Editing FX” on page 81 for more details.

5 Press “CLOSE” to return to the Record page, and continue recording as normal.

When Q-FX is enabled for recording (i.e., set to COMMAND or FX), a tick appears in the Q-FX button, as shown below.



6 Editing Samples

About Sample Editing

In Sample Edit mode, you can use the following functions to edit Samples.

TRIM: Enables you to play the section of a Sample specified by the Start and End points.

EDIT: Includes various editing functions, such as Time Stretch, Pitch Shift, Reverse Section, and Discard Section.

Q FX: Applies effects to Sample data to create a new Sample.

LOOP: Enables you to create sustained notes or repeated phrases by looping the section of a Sample.

REGION: Subdivides a Sample into smaller pieces.

B.P.M. Match: Enables you to change the tempo of a Sample in various ways.

Selecting Samples for Editing

You can Samples for editing as follows:

1 Press the SAMPLE button.

The SAMPLE button indicator lights up and the Z8 enters Sample mode.

2 Press “TRIM” to open the following TRIM page.

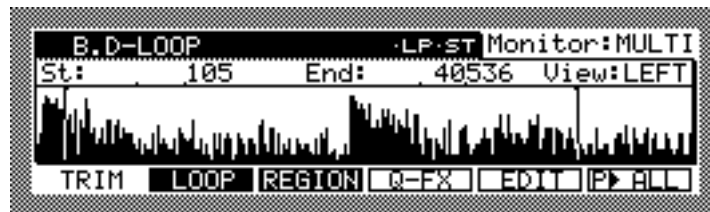

The Sample name appears in the upper left corner (Sample parameter).

3 Move the cursor to the Sample parameter, then use the JOG dial to select the Sample (that you want to edit) from memory.

Note: You can select the Sample on the LOOP or REGION page in the same way.

The indicator next to the Sample name indicates the Sample status.

LP: The Play mode of the selected Sample is set to Loop.

MN, ST: “.MN” indicates mono Samples, and “.ST” indicates stereo Samples.

New Samples created in Record mode, or Samples that have been edited after being loaded from disk, display an asterisk next to their name.

Tagging Samples

You can edit multiple Samples simultaneously by tagging them.

- 1 **Select the Sample name in the Sample parameter, then press the SHIFT button.**

The Function buttons change as shown below.

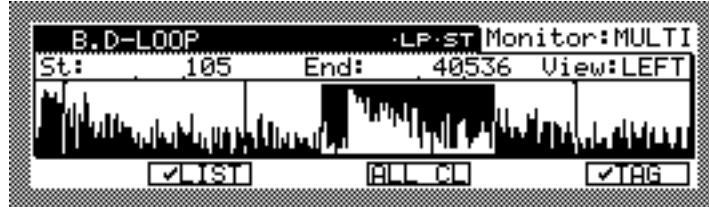

- 2 **To tag the Sample, press and hold the SHIFT button, then press “TAG.”**

Tagged Samples display a tick next to their name, as shown below.



To untag a Sample, press and hold the SHIFT button, then press “TAG” again. You can untag all Samples by holding down the SHIFT button and pressing “ALL CL.”

- 3 **To view tagged Samples, press “LIST” to open the Tag List window.**

You can also tag or untag Samples in the Tag List window.

Tagging Samples enables you to edit or delete the tagged Samples simultaneously.

When you tag Samples (with an asterisk next to their name) that were newly recorded, or edited after being loaded from the disk, the (⚡) mark appears instead of an asterisk.

Selecting a Monitoring Item

The “Monitor” parameter on the TRIM page enables you to select the item you wish to monitor in Sample mode. Select one of the following options by using the JOG dial:

SAMPLE: Enables you to monitor the selected Sample. This is the standard setting.

PROG: Enables you to monitor the Program selected in Program mode.

MULTI: Enables you to monitor the Multi selected in Multi mode.

If you wish to monitor how Samples play in the assigned Programs or Multis, set this parameter to “PROG” or “MULTI.”

Trimming Samples

You can view, zoom, and play the section of a Sample specified by the Start and End points to edit the Sample.

- 1 **Press the SAMPLE button.**

The SAMPLE button indicator lights up and the Z8 enters Sample mode.

- 2 **Press “TRIM” to open the following TRIM page:**

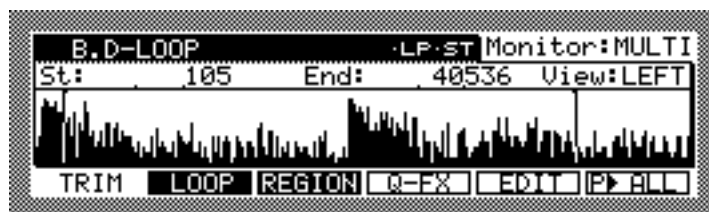

Viewing the Waveform

- 1 Select the “View” parameter, then use the JOG dial to select one of the following waveform views.

LEFT: You can view only the waveform of the left channel.

RIGHT: You can view only the waveform of the right channel.

MIX: You can view the waveform of a mix of left and right channels.

The waveform of the selected Sample looks something like this:

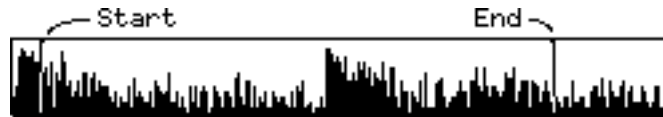

The waveform window covers the entire waveform of the selected Sample. The Start and End points are also displayed. You can also change the view of the Sample (i.e., linear or logarithmic) in the Waveform Display window, which you can access by pressing the WINDOW button while the “View” parameter is selected.

Zooming Samples

You can zoom Sample waveforms in and out as follows:

- 1 Select the “St” or “End” parameter, and hold down the SHIFT button.

The Function keys change as shown below:



- 2 While holding down the SHIFT button, press “ZOOM+” or “ZOOM-” to zoom in and out respectively.

Special Sample Playback for Auditioning

You can audition the Samples by using the following Function buttons:

“P>TO”

While the “St” or “End” parameter is selected, the F6 button displays the “P>TO” button function.

- 1 Press “P>TO” to audition a short duration of audio preceding the selected point.

SHIFT + “P>FROM” or “P>OVER”

While the “St” or “End” parameter is selected, pressing and holding the SHIFT button causes the Function buttons to change as shown below:



- 1 Press and hold the SHIFT button, then press “P>FROM” to audition the Sample starting from the selected point.
- 2 Press and hold the SHIFT button, then press “P>OVER” to audition the Sample starting from a short duration of audio preceding the selected point and continuing after the point.

“P>ALL,” “P>STOP”

While any parameter other than “St” and “End” is selected, the F6 button engages the “P>ALL” button function.

1 Press “P>ALL” to audition the entire Sample.

While auditioning is in progress, the “START,” “END,” and “P>STOP” buttons appear, as shown below:

**2 Press “P>STOP” to stop the audition.****“START,” “END”**

While auditioning the Sample by pressing “P>ALL,” you can grab the Start and End points of the Sample on the fly.

1 Press “START” at the point you want to set as the Start point, or press “END” at the point you want to set as the End point.

The Start or End point is set.

Setting the Start Point

You can also set the Start point set manually.

1 On the TRIM page, select the “St” parameter.**2 Use the JOG dial to specify the Start point.**

To quickly change the value, press and hold down the SHIFT button, and use the Left or Right CURSOR button to select the desired digit to change. Then use the JOG dial to change the number. In this way, you can make a coarse setting by changing the higher digits, then fine-tune the value by adjusting the units digit.

Setting the End Point

You can set the End point by various methods, depending on the “End” parameter display options. Note that the “End” parameter and its value can be selected independently. In Steps 1 and 2 below, you must select the parameter name, not the value.

1 Select “End,” then use the JOG dial to select one of the following options:

End: Displays the End point in points counted from the beginning of the Sample.

Length: Displays the length of the section between the Start and End points in points.

Time: Displays the length of the section between the Start and End points in hours, minutes, and seconds.

Beat: Displays the length of the section between the Start and End points in beats. (Note that this is not supported in Version 1.0 of the software. It will be supported in a future update.)

2 To open the End Display window, press the WINDOW button while the “End” parameter display option is selected.

In the End Display window, you can adjust the settings for the “Time” and “Beat” options.

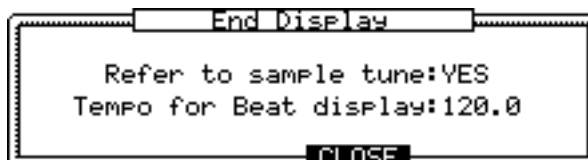

The End Display provides the following parameters. Select the desired parameter and use the JOG dial if necessary.

Refer to sample tune: This parameter determines whether the Time or Beat value references the Sample's tuning setting.

Tempo for Beat display: This parameter works with the Beat display option and determines the tempo referenced by the Beat display.

3 Press "CLOSE."

The End Display windows closes.

4 Select the "End" parameter (value), then use the JOG dial to set the End point value.

To quickly change the value, press and hold the SHIFT button, and use the Left or Right CURSOR button to select the desired digit to change. Then use the JOG dial to change the number. In this way, you can make a coarse setting by changing the higher digits, then fine-tune the value by adjusting the units digit.

Sample Edit

The Edit functions enable you to edit Samples via Time Stretch, Pitch Shift, etc., as well as by reversing or deleting a section of a Sample.

1 In Sample mode, press "EDIT."

The Sample Edit window appears.

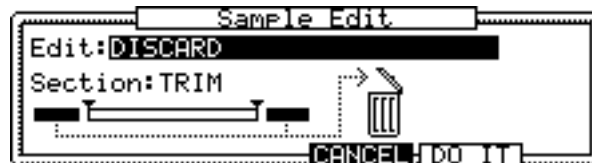

2 Select the parameters, then use the JOG dial to set them as required.

Edit: (DISCARD, RE-SAMPLE, EXTRACT, INSERT SAMPLE TO START, DELETE SECTION, SILENCE, REVERSE, PITCH SHIFT, JOIN A->B, FADE UP/DOWN, MERGE, NORMALIZE, RE-SCALE, TIME STRETCH, STEREO TO MONO, MONO TO STEREO) This parameter enables you to select the type of edit. The appearance of the Sample Edit window varies, depending on this setting.

Section: This parameter specifies the section to be edited, although some Edit functions are applied to the entire Sample.

3 Press "DO IT" to execute the selected Edit function.

The KEEP or RETRY window appears.

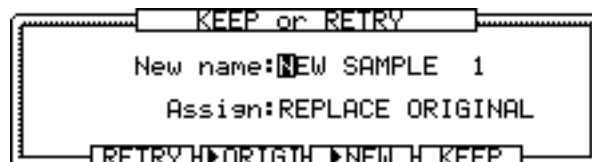

The KEEP or RETRY window usually appears after you edit a Sample.

4 Press ">NEW" to play the new Sample, or press ">ORIG" to play the original Sample.

5 To give the new Sample a new name, select the "New name" parameter, then rotate the JOG dial.

The Name window appears. See "Entering Names" on page 17 for more information.

- 6 Select the “Assign” filed, then use the JOG dial to select one of the following options to determine whether the new Sample will be assigned to a Program:

NONE: The new Sample is not assigned to a Program.

OVERWRITE: The new Sample will overwrite the original Sample and assume the name of the original Sample.

ADD TO PROGRAM: The new Sample will be added to a Program. See “Adding New Samples to Programs” on page 25 for more information.

REPLACE ORIGINAL: The new Sample will replace all occurrences of the original Sample in all Programs in memory.

- 7 Press “KEEP” to keep the new Sample in memory. If you don’t want to keep the new Sample in memory, press “RETRY” to discard it and return to the previous window.

Edit Functions

The following are the type of editing functions you can select in the Edit parameter in the Sample Edit window.

DISCARD

The Discard function deletes the data except for the selected section.

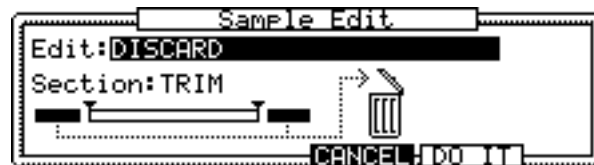

RE-SAMPLE

The Re-Sample function enables you to change a Sampling frequency and bit depth to re-sample a Sample.



Note that resampling a Sample with the “Quality” parameter set to “HIGH” will improve its sound quality. It will, however, slow processing.

EXTRACT

The Extract function extracts the selected section to create a new Sample.



INSERT SAMPLE TO START

The Insert Sample To Start function inserts a Sample into the current Sample at the specified Start point.



Use the “Insert” parameter to select a Sample to be inserted.

DELETE SECTION

The Delete Section function deletes the selected section.

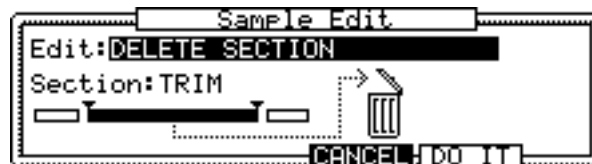

SILENCE

The Silence function mutes the selected section.



REVERSE

The Reverse function reverses the selected section.

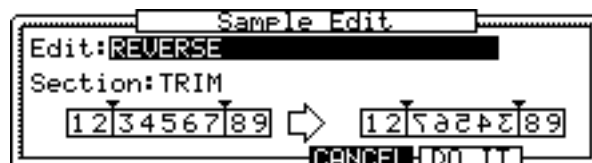

PITCH SHIFT

The Pitch Shift function enables you to change the pitch of the entire Sample.

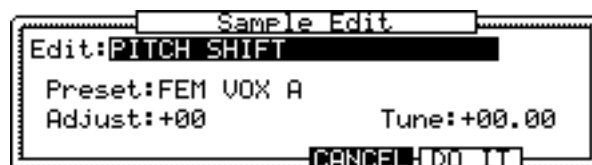

Preset: This parameter enables you to select a preset algorithm that suits the Sample.

The following preset algorithms are available:

FEM VOX (Female voice), MALE VOX (Male voice), LOW MALE VOX (Male bass voice), VOCAL, HFRQ RHYTHM (High-range rhythm section), MFRQ RHYTHM (Mid-range rhythm section), LFRQ RHYTHM (Low-range rhythm section), PERCUSSION, LFREQ PERC. (Low-range percussion), STACCATO, LFREQ SLOW (Low-range slow music), MUSIC 1, MUSIC 2, MUSIC 3, SOFT PERC. (Soft Percussion), HFREQ ORCH. (High-range orchestra), MFREQ ORCH. (Mid-range orchestra), LFREQ ORCH. (Low-range orchestra)

Each preset has variations of “A,” “B,” and “C.” Presets “A” feature standard quality and processing time. Presets “C” take more processing time, but improve quality. Presets “B” represent a compromise between “A” and “C.”

Adjust: This parameter allows fine adjustment of the quality. When it is set to a positive value, the quality of the high range improves, but the quality of the low range declines. When it is set to a negative value, the quality of the high range declines and the quality of the low range improves.

Tune: This parameter determines the amount of pitch shift.

JOIN A->B

The Join A->B function joins two Samples together.

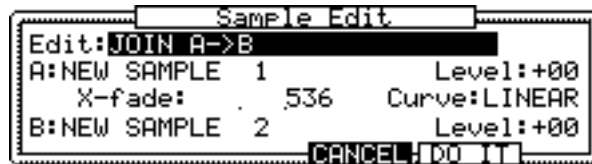

A, B: In these parameters, select Samples to join.

Level: Adjusts each Sample level.

X-fade: Sets the crossfade time to apply crossfade between the Samples.

Curve: Specifies the crossfade curve.

FADE UP/DOWN

The Fade Up/Down function enables you to apply a fade-in to the beginning of a Sample and a fade-out to the end of a Sample.



Up, Down: Set the fade-in and fade-out time.

Curve: Specifies the fade curve type.

MERGE

The Merge function enables you to merge Samples (i.e., mix into one Sample).

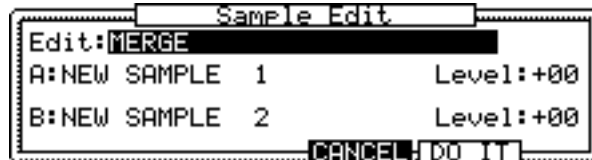

A, B: In these parameter, select Samples to merge.

Level: Sets each Sample level.

NORMALIZE

The Normalize function adjusts the Sample level to maximum.



Normalizing all Samples

- 1 Press “ALL” to normalize all Samples in memory.

The Normalize All Samples window appears.

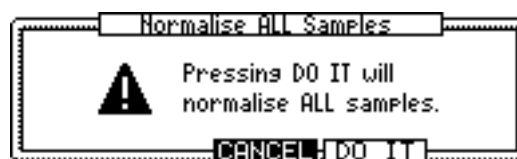

- 2 Press “DO IT” to execute.

The KEEP or REPLY window does not appear when all Samples are normalized.

Normalizing tagged Samples

- 1 Press “TAGGED” to normalize all Samples in memory.

The Normalize Tagged Samples window appears.

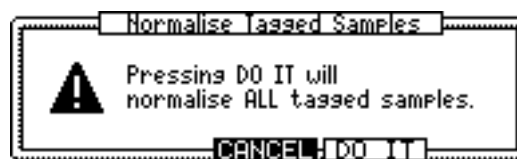

- 2 Press “DO IT” to execute.

The KEEP or REPLY window does not appear when tagged Samples are normalized.

Note: After the Normalize function is executed, the level of Samples changes. Therefore, when you normalize all Samples, the Program’s level balance may change.

RE-SCALE

The Re-scale function enables you to change the level of a Sample.



When “MAX” is pressed, the Z8 scans the entire Sample and automatically calculates the maximum amount of gain that can be applied before saturation. The calculated value appears at the “Level” parameter.

TIME STRETCH

The Time Stretch function enables you to change the speed of Samples without affecting their pitch.



Amount: This sets the amount of speed to be changed as a percentage. The “Preset” and “Adjust” parameters are the same as those for the Pitch Shift function.

STEREO TO MONO

The Stereo To Mono function enables you to convert stereo Samples to two mono Samples.



Name the L channel and R channel Sample names by using the “New Left Name” and “New Right Sample” parameters.

MONO TO STEREO

The Mono To Stereo function enables you to convert two mono Samples to create a new stereo Sample.



Select an L-channel Sample for the “L source” parameter and an R-channel Sample for the “R source” parameter, then enter a name for the new stereo Sample in the “New ST name” parameter.

Resampling with Q-FX

You can resample a Sample with Q-FX, creating a new Sample in the process.

- 1 On the TRIM page, press “Q-FX.”

The Quick FX Resampling window appears.

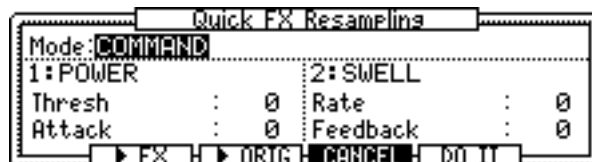

The Quick FX Resampling function offers two modes: COMMAND and FX.

- 2 Select the “Mode” parameter, then use the JOG dial to set the mode.

COMMAND mode

You can apply Q-FX by using intuitive command names, such as POWER and SWELL. The parameters settings for the selected Command appears on the display.

The following Q-FX types are available:

Q-FX	Parameters (-10 to +10)	
POWER	Threshold	Attack
SWELL	Rate	Feedback
DISTORT	Depth	Tone
CRISP	Depth	Tone
GROW DRUM	Tune	Depth
MASSIVE DR	Tune	Depth
WHIRL	Rate	Feedback
DISTANCE	Wide	Shape
COSMO	Rate	Depth
RUMBL	Time	Depth
ROBOT	Delay	Depth
UNDERSEA	Rate	Depth

In Command mode you can apply two Q-FX simultaneously.

- 1 Press “>FX” to audition the processed Sample, or press “>ORIG” to listen to the Sample without any Q-FX.
- 2 Press “DO IT” to resample the Sample with the selected Q-FX.

The KEEP or RETRY window appears. See “Sample Edit” on page 33 for more information on the KEEP or RETRY window.

FX mode

You can apply Q-FX in FX mode in the same manner as FX processors in Effect mode. In FX mode, the operation is more complicated but allows detailed settings.



You can apply up to four FX when resampling mono Samples; two when resampling stereo Samples.

- 1 Select the Effect name parameter, then turn the JOG dial.
The Select Effect window appears.
- 2 Use the JOG dial to select the effect, then press “SELECT.”

The “Wet|Dry” parameter sets the balance between the effect and the direct sound. The “Effect” parameter specifies On or Off for each FX.

- 3 Press “EDIT” to display the Effect Edit window.

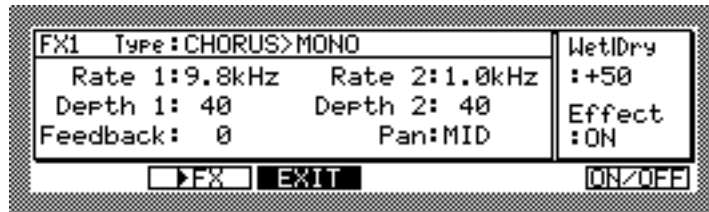

You can audition the processed Sample by pressing “>FX.” Press “EXIT” to return to the Quick FX Resampling window. For information on using FX, see “Editing FX” on page 81.

- 4 In the Quick FX Resampling window, press “DO IT” to execute the Quick FX Resampling function.

The KEEP or RETRY window appears. For more information on the KEEP or RETRY window, see “Sample Edit” on page 33.

Setting Loops

You can create sustained notes or repeated phrases by looping a short Sample or a section of a Sample.

- 1 Press the SAMPLE button to select Sample mode, then press “LOOP” to display the LOOP page shown below.



The operation related to the waveform display is the same as on the TRIM page, except that the LOOP page indicates the waveform of the looped section. The display of the looped section differs, depending on whether the Loop function is on or off.

Loop is On



Loop is Off

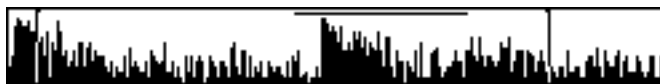

- 2 Select the “Mode” parameter, then use the JOG dial to select one of the following options to determine how the Sample is played:

NO LOOP: The Loop function is turned off. The Sample playback is triggered by the Note On message, and stopped by the Note Off message. If the end of the Sample is reached before the Note Off message is received, playback stops.

LOOP: The Loop function is turned on. The Sample playback is triggered by the Note On message, and the specified section loops repeatedly until the Note Off message is received.

ONE SHOT: The Loop function is turned off. The Sample playback is triggered by the Note On message, and continues until the end of the Sample. The Note Off message will be ignored. This option works well with drum Samples.

You can also set the Play mode on the REGION page.

3 Press the WINDOW button while the “Mode” parameter is selected.

The Play Mode window appears, enabling you to make detailed settings.



4 Select the parameters and set them as required.

Play mode: This is the same as the “Mode” parameter on the LOOP page.

Repeat: This parameter specifies the number of repeats for loop playback. With the “HOLD” option, the Sample continues looping as long as the Note On message is in effect.

Loop type: (LOOP IN RELEASE or LOOP UNTIL RELEASE) This parameter determines how the loop plays when the key is released. When it is set to “LOOP IN RELEASE,” the Sample continues looping in release even after the Note Off message is received. When it is set to “LOOP UNTIL RELEASE,” the Sample continues looping until the Note Off message is received, then the remainder of the Sample is played.

Direction: (FORWARD or ALTERNATING) This determines the loop direction. When it is set to “FORWARD,” the Sample plays the looped section up to the End point, then returns to the Start point and continues playing. When it is set to “ALTERNATING,” the Sample plays the looped section from start to end, end to start, start to end, and so on.

Setting and Fine-tuning the Loop Start & End Points

You can set the Loop Start and Loop End points in the same way as the Start and End point on the TRIM page.

You can fine-tune the Loop Start and Loop End points in the Loop Fine window.

1 Select the “St” or “LP End” parameter, then press the WINDOW button.

The Loop Fine window appears.

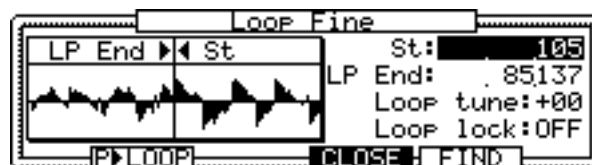

You can view the waveform where the loop points meet. The section of the Sample waveform immediately before the Loop End point is shown on the left, while the section immediately after the Loop Start point is shown on the right. In this way, you can edit the Loop points while observing the “joint.”

2 Select the “St” or “LP End” parameter, then use the JOG dial to edit the parameter.

3 Select the “Loop tune” and “Loop lock” parameters, then use the JOG dial to set the parameters as required.

Loop tune: You can use this parameter to set the pitch of the loop independently of the Sample’s Tuning parameter. This is useful when you wish to adjust the pitch of a short loop section from which to build a sustained note.

Loop lock: When this parameter is set to ON, the loop is locked at the current length, so that when the “St” parameter is adjusted, the “LP End” parameter is automatically adjusted in order to maintain the loop length. This is useful when you wish to change the Loop points without changing the length of the loop.

Auto Loop Find Functions

The Auto Loop Find function can find the optimum loop points automatically.

- 1 In the Loop Fine window, press “FIND.”

The Find Loop Point window appears.

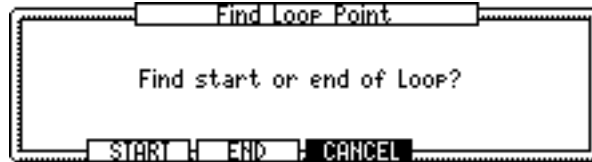

- 2 Press “START” to search for an optimum Loop Start point, and press “END” to search for an optimum Loop End point.

The Auto Loop Find function helps you set Loop points. If you cannot find the optimum Loop points, set the point manually or try to set the crossfade Loop.

Crossfading Loops

The Crossfade function applies a crossfade at the loop point, which can make the transitions at the Loop Start and Loop End points less noticeable. This is especially useful if you have a loop with audible clicks.

- 1 On the LOOP page, press “X-FADE.”

The X-fade loop window appears, as shown below.

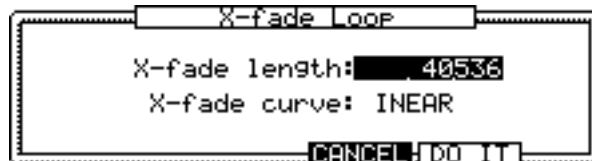

- 2 Select the “X-fade length” and “X-fade curve” parameters, then use the JOG dial to set them.

X-fade length: Sets the length of the crossfade.

X-fade curve: (LINEAR, LOG, SINE) Specifies the type of the crossfade curve.

- 3 Press “DO IT.”

The edit is performed, and the KEEP or RETRY window appears.

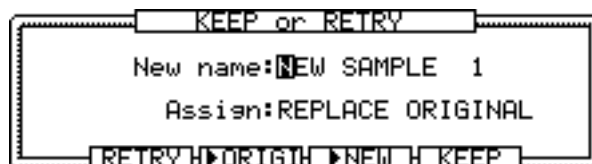

You can listen to the Sample without any crossfade by pressing “>ORIGI” and audition the processed Sample by pressing “>NEW.” To discard the processed Sample and return to the X-fade loop window, press “RETRY.” See “Sample Edit” on page 33 for information on the “Assign” parameter.

Setting Regions

A section of a Sample can be divided into as many as 32 Regions, as follows. This is useful when you edit phrase Samples.

- 1 Press the **SAMPLE** button to enter Sample mode, then press “**REGION.**”

The REGION page appears (shown below).

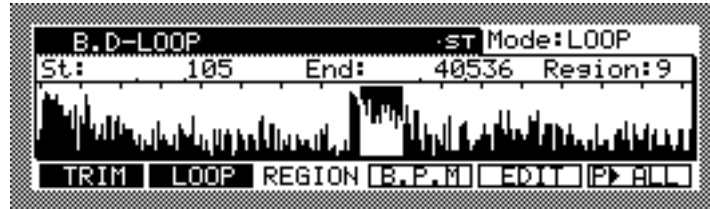

Regions are sections into which a Sample is divided. The Start and End points of each region appears as markers in the upper part of the waveform. The selected region is highlighted as shown below.

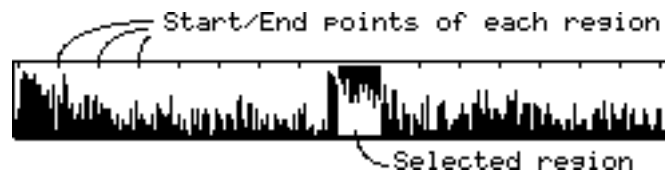

- 2 Select the “Region” parameter, then use the JOG dial to select a Region.
- 3 In the “Region” parameter, press the **WINDOW** button.

The Number of Regions window appears, as shown below.

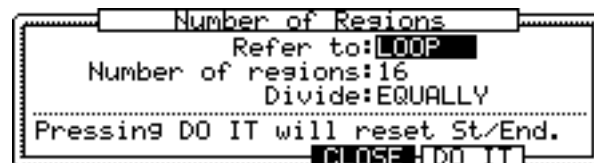

In the Number of Regions window, you can change the number of regions and adjust for the Regions setting.

- 4 Select the parameters, then use the JOG dial to set them as required.

Refer to: (LOOP, TRIM, SAMPLE) This is used to select the section of the Sample that you want to divide into Regions. When the parameter is set to “LOOP;” the section between the specified Loop Start and Loop End points is used to create Regions. When it is set to “TRIM;” the section between the specified Start and End points is used to create Regions. And when it is set to “SAMPLE;” the entire Sample is used to create Regions.

Number of regions: (1–32) This determines the number of Regions.

- 5 Press “**DO IT**” to set the Regions.

The Number of Regions window closes.

Adjusting Region Start & End Points

You can adjust the Region Start and End points in the same way as the Start and End points on the TRIM and LOOP pages. However, since the Start point of each Region is the same as the End point of the previous Region, adjusting the Start point of the current Region also adjusts the End point of the previous Region. Likewise, adjusting the End point of a Region also adjusts the Start point of the subsequent Region.

Slicing Regions

You can slice a Sample into Regions and make them new individual Samples.

- 1 On the Region page in Sample mode, press “EDIT” to display the Sample Edit window.
- 2 Select the “Edit” parameter, then use the JOG dial to select “SLICE.”

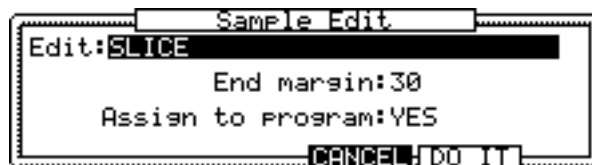

- 3 Select the parameters, then use the JOG dial to set them as required.

End margin: This parameter specifies how the End point of the Region is treated. When it is set to zero (“0”), the End point of the Sample created from the Region is the same as the Region End point. When it is set to any number other than zero, the End point of the newly-created Sample is located after the Region’s End point, by the amount specified by this parameter. This extra “padding” prevents interruptions or gaps between the Samples when you sequence the sliced Samples and play them from a sequencer with a slow tempo.

Assign to program: This parameter specifies whether or not the created Sample is assigned to a Program.

- 4 To assign the newly-created Sample to a Program, select “YES” for the “Assign to program” parameter in the Sample Edit window, then press “DO IT.”

The Assign to Program window appears.

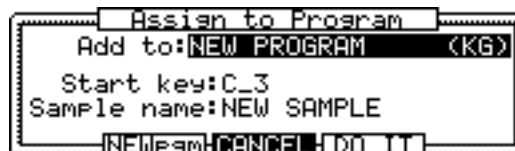

- 5 Select the parameters, then use the JOG dial to set them as required.

Add to: Specifies a Program to which you wish to assign the new Sample. You can create a new Program by pressing “NEWpgm.”

Start key: Specifies the key note to which the first Sample is assigned. The rest of the Samples are automatically assigned to the next highest notes in order.

Sample name: Specifies the name of the new Sample. When you turn the JOG dial on this parameter, the Name window appears. See “Entering Names” on page 17 for more information. The name you enter here, plus an instance number, is applied to the created Samples. For example, if you entered “METAVIBE” as the Sample name, the first Sample is named “METAVIBE 1,” the second Sample is named “METAVIBE 2,” and so on.

- 6 Press “DO IT” to assign the Samples to the Program.

BPM Tempo Matching

You can adjust the tempo of a Sample in two ways, as follows.

1 On the REGION page, press “B.P.M.”

The BPM Match window appears.

You can adjust the tempo by tuning or stretching.

2 Select the “Edit” parameter, then use the JOG dial to select “TUNE (PITCH CHANGED)” or “STRETCH (NO PITCH CHANGE).”

TUNE (PITCH CHANGED)

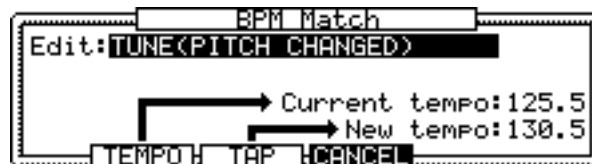

The tempo of a Sample is adjusted by changing its pitch.

STRETCH (NO PITCH CHANGE)

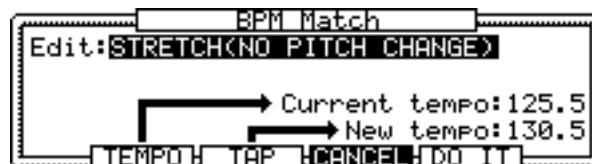

The tempo of a Sample is adjusted without changing its pitch by the Time Stretch function.

3 Select the “Current tempo” parameter, then use the JOG dial to set the current tempo.

If you don't know the current tempo, you can use the Tempo Calculator, shown below. You can access the Tempo Calculator by pressing “TEMPO.”

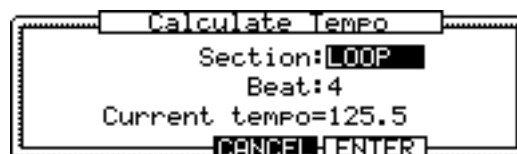

Select the parameters, then use the JOG dial to set them.

Section: Specifies the length of a section for use with the tempo calculation.

Beat: This parameter should be set to the number of beats per bar of the phrase.

Current tempo: The Tempo Calculator calculates the tempo based on the “Section” parameter and “Beat tempo” parameter. The calculated tempo is displayed here.

4 Press “ENTER.”

The Calculate Tempo window closes, and the “Current tempo” parameter on the BPM Match window indicates the calculated value.

5 Select the “New tempo” parameter, then use the JOG dial to specify the new tempo.

You can also tap in a tempo using “TAP.”

If you selected “TUNE (PITCH CHANGED)” for the “Edit” parameter, the pitch and tempo change automatically as the “New tempo” parameter is adjusted.

6 If you selected “STRETCH” for the “Edit” parameter, press “DO IT”

The Stretch Quality window appears, as shown below.

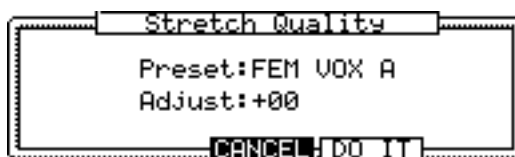

7 Set the “Preset” and “Adjust” parameters as required.

The “Preset” and “Adjust” parameters are the same as those for the Pitch Shift function (see page 35).

8 Press “DO IT.”

Renaming Samples

You can rename the selected Sample as follows.

1 Select the Sample name in the upper-left corner of the TRIM, LOOP, or REGION page, then press the WINDOW button.

The Sample window appears, as shown below.

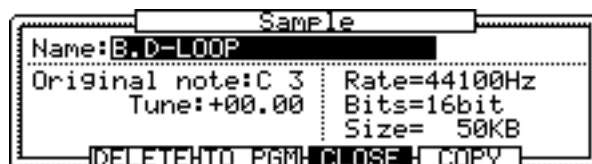

Name: This is the name of the selected Sample. To rename the Sample, rotate the JOG dial to open the Name window. See “Entering Names” on page 17 for more information on using the Name window.

Original note: This determines the note at which the selected Sample plays at its original pitch.

Tune: This allows you to fine-tune the pitch of the Sample in semitone and cent steps.

Rate: This is the sampling rate of the selected Sample.

Bits: This is the bit resolution of the selected Sample.

Size: This is the size of the selected Sample in kilobytes.

Copying Samples

Samples can be copied as follows.

1 While the Sample you wish to copy is selected for the “Name” parameter in the Sample window (shown above), press “COPY.”

The Copy Sample window appears, as shown below.



Sample: This is the name of the selected Sample.

New name: Enter a name for the new Sample here by rotating the JOG dial. The Name window appears. See “Entering Names” on page 17 for more information.

2 Press “DO IT.”

The Sample is copied.

Deleting Samples

You can delete individual, tagged, or all Samples as follows.

- 1 In the Sample window shown on page 46, press “DELETE.”

The Delete Sample window appears, as shown below.



- 2 Make sure that the “Sample” parameter indicates the Sample you wish to delete. Otherwise, use the JOG dial to select a Sample you wish to delete.
- 3 To delete only the selected Sample, press “DO IT.” To delete all Samples, press “ALL.” To delete only the tagged Sample, press “TAGGED.” To cancel the operation, press “CANCEL.”

If you pressed “DO IT,” the selected Sample is deleted.

If you pressed “ALL,” the Delete ALL Samples window appears, as shown below.

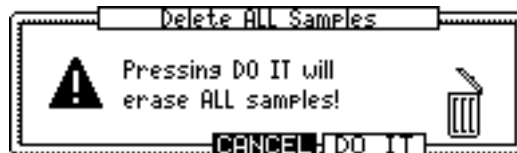

Press “DO IT.” All Samples in memory are deleted.

If you pressed “TAGGED,” the Delete Tagged Samples window appears, as shown below.

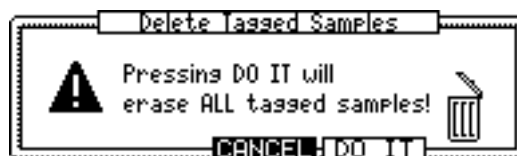

Press “DO IT.” Only the tagged Samples in memory are deleted.

Adding Samples to Programs

Samples selected in the Sample window can be added to Programs as follows.

- 1 While the Sample name is selected in the Sample window (page 46), press “TO PGM” to open the Add to Program window.

See “Adding Samples to Programs” on page 47 for information on using the Add to Program window.

7 Using Programs

About Program Mode

This chapter explains how to create and edit Programs in Program mode. In Program mode you can play only one Program at a time. In Multi mode you can play many Programs simultaneously. See page 67 for information on using Multi mode.

Selecting Programs

Programs can be selected for playing and editing as follows.

1 Press the PROGRAM button.

The PROGRAM button indicator lights up and the MAIN page appears.

The MAIN page for Keygroup Programs is shown below.

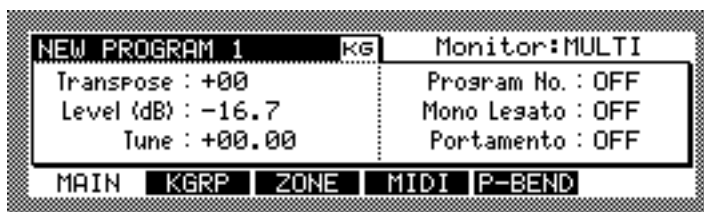

The MAIN page for Drum Programs is shown below.

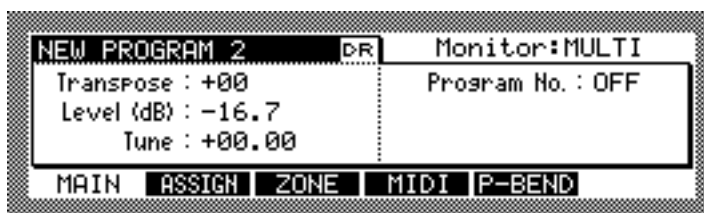

2 Select the Program name, and then use the JOG dial to select a Program.

Only Programs already in memory can be selected. To select a Program stored on a storage device, you must load it first. See “Loading” on page 18 for more information.

New Programs, or Programs that have been edited, have an asterisk next to their name if they have not yet been saved, as shown below.

*** NEW PROGRAM 1 KG**

See “Saving” on page 84 for information on saving Programs.

You can edit multiple Programs simultaneously by tagging them. To tag a Program, select the Program name in the upper-left corner, press and hold the SHIFT button, and then press “TAG,” as shown below.

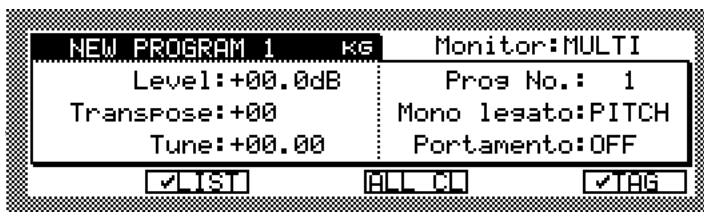

Tagged Programs have a tick next to their name, as shown below.



To untag a Program, press and hold the SHIFT button, and then press “TAG” again. You can untag all Programs by pressing “ALL CL.” Programs can also be tagged on the Tag List window, shown below, which is accessed by pressing “LIST.”

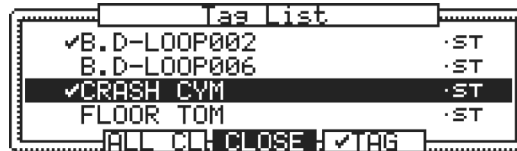

Use the JOG dial or Up and Down CURSOR buttons to select Programs, and press “TAG” to tag or untag the selected Program. Tagged Programs have a tick next to their name. Press “ALL CL” to untag all tagged Programs.

Configuring Programs

Keygroup and Drum Programs can be configured as follows.

1 Press the PROGRAM button.

The PROGRAM button indicator lights up and the MAIN page appears.

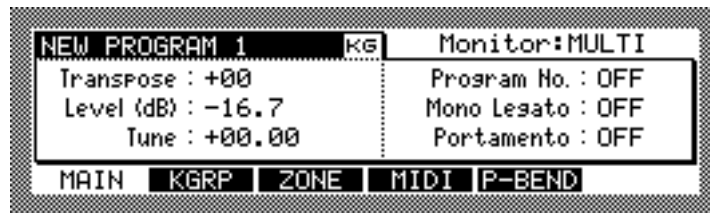

2 Select the Program name, and then use the JOG dial to select a Program.

3 Select the parameters, and use the JOG dial to set them as required.

Monitor: (OMNI or MULTI) This parameter determines how the selected Program responds to MIDI data in Program Mode. When this parameter is set to “OMNI,” the Program can be played via any MIDI Channel. When it is set to “MULTI,” you can monitor the currently-selected Multi.

Level: (-60.0 to +6.0) This sets the output level of the Program.

Transpose: (-36 to +36) This can be used to transpose incoming MIDI note messages.

Tune: (-36.00 to +36.00) This sets the pitch of the Program in semitone and cent steps.

Program No. (1–128 or OFF) This parameter determines the MIDI Program Change that will select the Program. When set to “OFF,” the Program ignores MIDI Program Change messages.

Pressing the WINDOW button while the “Program No” parameter is selected opens the Program List window, shown below, which can be used to assign Program Change numbers to Programs.

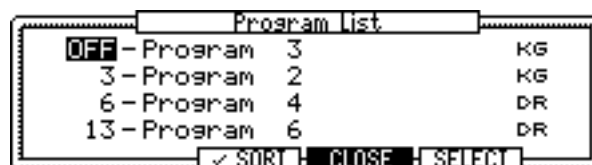

Use the CURSOR Up and Down buttons to scroll the list of Programs. You can also use the JOG dial to scroll the list while any Program name is selected. To assign a MIDI Program Change number to a Program, select its number, then use the JOG dial to select the desired Program number. Press “SORT” to sort Programs. If “SORT” has a check mark next to it, Programs are sorted in the order of Program numbers.

Mono legato: (PITCH, OFF) This parameter, which applies only to Keygroup Programs, sets the Mono Legato mode. When the parameter is set to “PITCH,” the selected Program becomes mono (you cannot play chords using the Program). If one note is held and another played, the pitch of the Sample changes to the new note, without triggering the next Sample. When set to “OFF” the Mono Legato function is off.

Portamento: (ON, OFF) This parameter, which applies only to Keygroup Programs, is used to turn on and off the Portamento function.

More Portamento parameters are available on the Portamento window, shown below, which is accessed by pressing the WINDOW button while the “Portamento” parameter is selected.

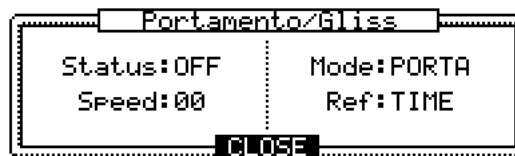

The “Status” parameter is the same as the “Portamento” parameter on the MAIN page and can be set to either “ON” or “OFF.” The “Speed” parameter determines the rate of pitch change. The “Mode” parameter selects “PORTA” (portamento: a smooth uninterrupted glide between notes) or “GLISS” (glissando: a smooth glide in semitone steps between notes). The “Ref” parameter determines how the pitch changes. When set to “SPEED,” the pitch changes at a constant speed, so the further the notes are apart, the longer it takes to change the pitch. When set to “TIME,” the pitch changes at a constant time, regardless of the distance between notes.

Creating Keygroup Programs

Keygroup Programs can be created as follows. See page 2 for more information on Keygroup Programs.

1 Press the PROGRAM button.

The PROGRAM button indicator lights up and the MAIN page appears.

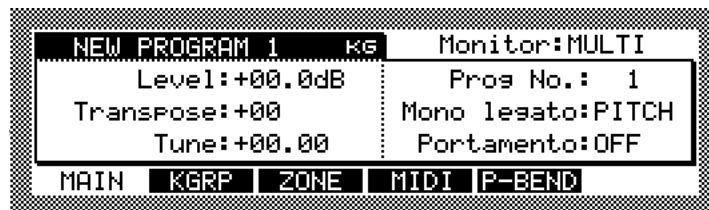

2 Select the Program name, and then press the WINDOW button.

The Program window appears, as shown below.



3 Press “NEW.”

The Create New Program window appears, as shown below.

**4 Select the “Type” parameter, then use the JOG dial to select “KEYGROUP.”****5 Select the “New name” parameter, then rotate the JOG dial.**

The Name window appears. See “Entering Names” on page 17 for more information.

6 Press “DO IT.”

A new Keygroup Program is created.

Configuring Keygroup Programs

Keygroup Programs are configured as follows.

1 Select a Keygroup Program as explained on page 48.**2 Press “KGRP.”**

The KGRP page appears, as shown below.

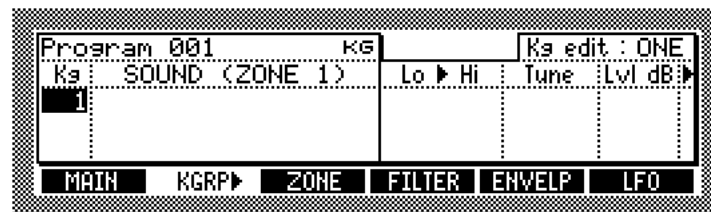

KGRP parameters are spread over two pages, which you can toggle between by pressing “KGRP,” or select by using the Right and Left CURSOR buttons.

New Programs contain one blank Keygroup (i.e., no Samples assigned), as shown in the example above. New Keygroups can be created as follows. If you do not need to create any more new Keygroups, go to step 7.

3 Select either a Keygroup number in the “Kg” column or the “Kg edit” parameter, and then press the WINDOW button.

The Key Group window appears, as shown below.



The Key Group window also contains the Keygroup Delete and Arrange functions. When you press “DELETE,” the Delete Keygroup window appears, from which you can delete the current Keygroup, or delete all blank Keygroups (i.e., those without a Sample assigned). When you press “ARRANG,” the Arrange Keygroup window appears, and you can sort Keygroups by selecting “ORIGINAL KEY” (i.e., Original Note), “KEYRANGE LOW,” or “KEYRANGE HIGH” in the “In order of” parameter.

4 Press “CREATE.”

The Create New Keygroup window appears, as shown below.

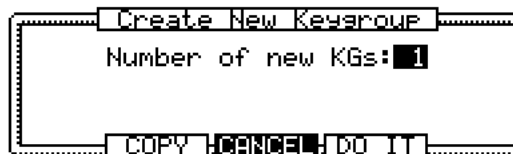

5 Use the JOG dial to specify the number of new Keygroups that you want to create.

6 Press “DO IT.”

The specified number of Keygroups are created. Additional Keygroups can be created at any time.

7 Select the “Kg” column, and use the JOG dial to select a Keygroup.

8 In the “SOUND (ZONE1)” column, use the JOG dial to select a Sample.

Only Samples already in memory can be selected. See page 18 for information on loading Samples.

If you have created a new Program, start by assigning Samples to Keygroups.

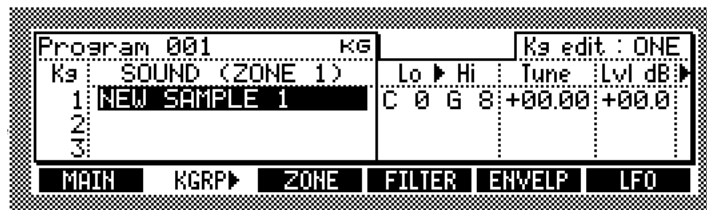

You can clear a Sample assignment by selecting the Sample name in the “SOUND (ZONE1)” column, and then rotating the JOG dial fully counterclockwise until a blank space appears.

To quickly locate and select Keygroups, press and hold the SHIFT button while playing a connected MIDI keyboard.

9 Select the Keygroup’s “Lo” parameter, as shown in the example below, and then use the JOG dial to set the Keygroup’s low note. Do the same for the “Hi” parameter.

The “Lo” and “Hi” parameters determine the Keyspan of each Keygroup.

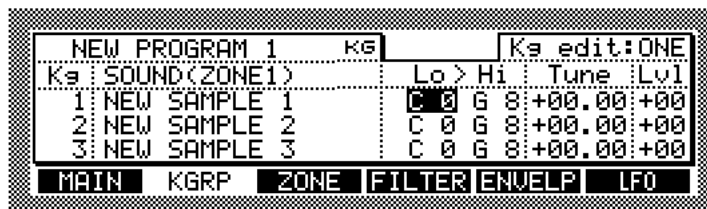

10 While a “Lo” or “Hi” parameter is selected, press the WINDOW button.

The Key Span window appears, as shown below.

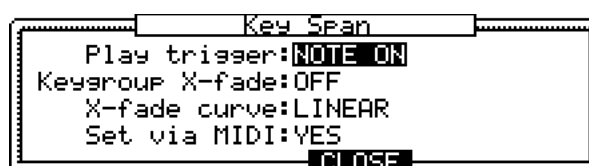

11 Set the parameters as required, and press “CLOSE” when finished.

Play trigger: (NOTE ON, NOTE OFF, TOGGLE) This parameter determines how notes trigger the Keygroup. When it is set to “NOTE ON,” Sample playback is triggered by Note Ons, and playback is stopped by Note Offs. This is normal operation. When it is set to “NOTE OFF,” the “Vel” parameter for the velocity setting appears. Playback is triggered by Note Offs. When the “Vel” parameter is set to 0–127, Samples play at that velocity. When the “Vel” parameter is set to “AS N-ON,” Samples play at the same velocity as the Note On. When the set to “AS N-OFF,” Samples play at the Note Off velocity.

When it is set to “TOGGLE,” the Note On message triggers the Sample playback. The playback continues, ignoring the Note Off message. When the Note On message is received for the second time, playback stops.

Keygroup X-fade: (OFF, ON) When set to “ON,” a crossfade is applied to notes where Keygroups overlap.

X-fade curve: (LINEAR, EXPONENTIAL, LOGARITHMIC) This selects the curve for the crossfade between overlapping Keygroups.

Set via MIDI: (NO, YES) This determines whether or not a connected MIDI keyboard can be used to set the Keyspan. When set to “YES,” and either the Keyspan “Lo” or “Hi” parameter is selected, the MIDI keyboard can be used.

12 To view the Keygroup’s Keyspan settings graphically, select “SOUND (ZONE1),” and use the JOG dial to select “KEY SPAN.”

The KGRP page changes, as shown below.

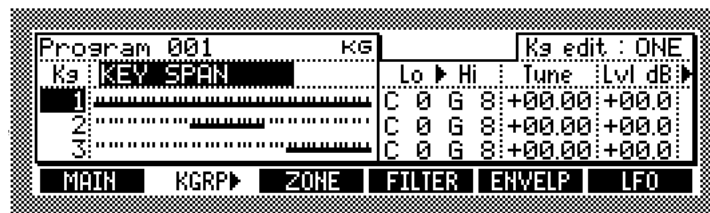

A keyboard graphic appears in place of each Sample name, indicating the Keyspan of each Keygroup. To view the “Lo” and “Hi” parameters as MIDI note numbers, select any “Lo” or “Hi” parameter, and press the SHIFT button. You can set the default note view in Utilities mode (see page 89).

13 Select the “Tune” and “Lvl” (level) parameters, and use the JOG dial to set them as required.

Tune: (–36.00 to +36.00) This sets the tuning for each Keygroup in semitone and cent steps.

Lvl: This sets the level of each Keygroup.

You can edit the selected parameter in all Keygroups simultaneously by setting the “Kg edit” parameter in the upper-right corner of the KGRP or ZONE page. When the parameter is set to “ONE,” you can edit each Keygroup one by one. When set to “ALL,” edits apply to all Keygroups absolutely. So if the Level of one Keygroup is set to “+10,” the Level of all Keygroup are set to “+10.” When set to “ADD,” edits apply to all Keygroups relatively. So if Keygroup #1 has a Level of “50,” and Keygroup #2 has a Level of “30,” increasing the Level of any Keygroup by “10” will change the Level of Keygroup #1 to “60,” and that of Keygroup #2 to “40.” The “ALL” and “ADD” options do not work for Sample assignment or the Keyspan (i.e., “Lo” and Hi”) parameters.

- 14 Press “KGRP” to select the other KGRP page, or use the Right CURSOR button.

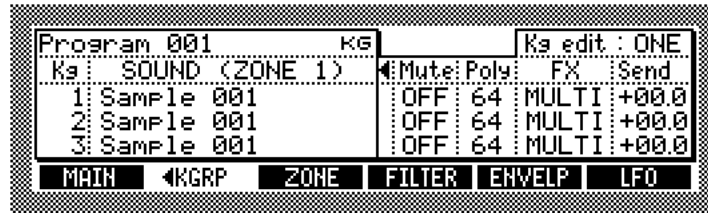

- 15 Select the parameters, and use the JOG dial to set them as required.

Mute: (OFF, 1–64) This is used to add the Keygroup to a Mute Group. When the notes of a Keygroup in a Mute Group are played, the notes of any other Keygroups in the same Mute Group are muted.

Poly: (1–64) This sets the maximum number of voices that can be played simultaneously in each Keygroup.

Pressing the WINDOW button while the “Mute” parameter is selected opens the Mute Group window, shown below, which lists all of the Keygroups assigned to the Mute Group selected at the top of the Window.

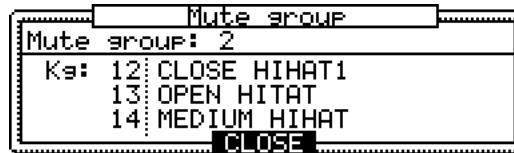

FX: (A, B, C, D, AB, CD, OFF, or MULTI) When the parameter is set to “MULTI,” if the Program is assigned to a Part in the currently-selected Multi, the setting specified for the Part is applied. If you wish to use the FX with only a certain Keygroup (such as a Drum Kit Program), the FX output follows the Keygroup’s setting, not the Part’s setting, even if the Program has been assigned to the Part. Select “AB” or “CD” to use the FX with stereo inputs.

Send: This sets the FX Send level of each Keygroup.

In addition to assigning Keygroups to FX Sends, you must also configure the FX processors to use FX. See “Using FX” on page 78 for more information.

- 16 Press “ZONE.”

The ZONE page appears, as shown below.

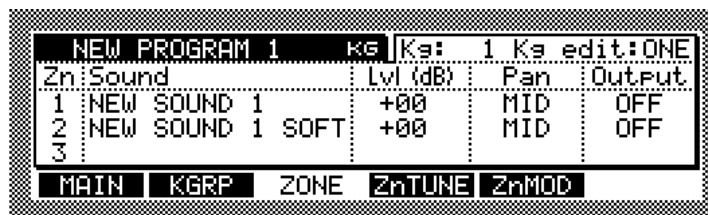

A Keygroup may contain up to four Samples, organized as Zones. All Zones in a Keygroup have the same Keyspan. On the ZONE page you can assign Samples to each Zone, and set the level, pan, and output for each Zone. See “Programs” on page 2 for more information on Keygroups and Zones.

- 17 Select the “Kg” parameter, and use the JOG dial to select a Keygroup.

- 18 Select the parameters and set them as required.

Lvl (dB): This sets the level of the Zone.

Pan: (L50–MID–R50) This sets the pan position of the Zone.

Output: (L/R, L, R, 1/2, 3/4, 5/6, 7/8, 1–8, MULTI) The output of each Zone can be fed to the MAIN OUT, an individual left or right MAIN OUT, a pair of individual outputs (if IB-48P/IB-4ADT installed), or a single individual output (if IB-48P/IB-4ADT installed). When the parameter is set to “MULTI,” if the Program is assigned to a Part in the currently-selected Multi, the Zone’s output is fed to the output specified in that Part.

19 Press “ZnTUNE.”

The ZnTUNE page appears, as shown below.

NEW PROGRAM 1		Ks	Ka: 1	Ka edit:ONE
Zn	Sound	Tune	Pitch	Playback
1	NEW SOUND 1	+00.00	TRACK	AS SAMPL
2	NEW SOUND 1 SOFT	+00.00	CONST	AS SAMPL
3		+00.00	TRACK	AS SAMPL

MAIN | KGRP | ZONE | ZnTUNE | ZnMOD

20 Select the parameters and set them as required.

Tune: This allows you to tune each Zone in semitone and cent steps.

Pitch: (TRACK, CONST) This determines how each Zone responds to pitch changes. When set to “TRACK,” the pitch tracks the keyboard (i.e., the note played determines the pitch). When set to “CONST,” the pitch is constant regardless of the note played.

Playback: (ONE SHOT, NO LOOP, LOOP, AS SAMPL) This determines the Play mode of each Zone. When set to “ONE SHOT,” Note On messages cause Samples to play to their end regardless of any Note Off messages. When set “NO LOOP,” the Sample plays without looping for as long as the key is pressed. When set to “LOOP,” Sample playback is looped while the key is pressed. When set to “AS SAMPL,” Samples play according to their own Play mode setting.

21 Press “ZnMOD.”

The ZnMOD page appears, as shown below.

NEW PROGRAM 1		Ks	Ka: 1	Ka edit:ONE
Zn	Sound	Filter	Start	Range
1	NEW SOUND 1	+000	+0000	0 127
2	NEW SOUND 1 SOFT	+000	+0000	0 64
3				

MAIN | KGRP | ZONE | ZnTUNE | ZnMOD

22 Select the parameters and set them as required.

Filter: This allows you to offset the Filter cutoff frequency for each Zone.

Start: This determines the amount by which the Sample Start point is offset via velocity. The offset can be controlled not only by velocity but by Control Change too.

Range: These two settings determine the velocity range of MIDI notes that will play the Zone.

Pressing the WINDOW button while the “Range” parameter is selected opens the Zone X-fade window, shown below, which is used to configure crossfading between Zones.

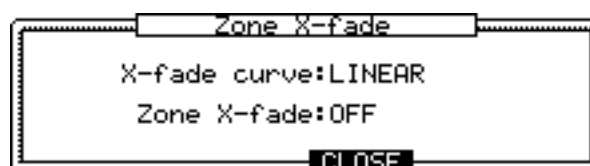

Use the “Zone X-fade” parameter to turn crossfading between Zones “ON” or “OFF.”
 Use the “X-fade curve” parameter to select a crossfade curve. The default setting of the “Zone X-fade” function is “VELOCITY,” which can be changed to other sources, such as Control Change, in the Program Modulation window.

Creating Drum Programs

Drum Programs can be created as follows. See page 2 for more information on Drum Programs.

1 Press the PROGRAM button.

The PROGRAM button indicator lights up and the MAIN page appears.

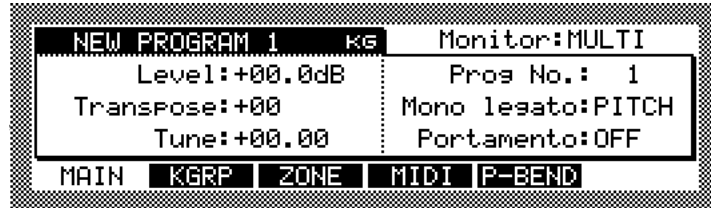

2 Select the Program name, and then press the WINDOW button.

The Program window appears, as shown below.



3 Press “NEW.”

The Create New Program window appears, as shown below.



4 Select the “Type” parameter, and then use the JOG dial to select “DRUM.”

5 Select the “New name” parameter, and then rotate the JOG dial.

The Name window appears. See “Entering Names” on page 17 for more information.

6 Press “DO IT.”

A new Drum Program is created.

Configuring Drum Programs

Drum Programs can be configured as follows.

1 Select a Drum Program as explained on page 48.

2 Press “ASSIGN.”

The ASSIGN page appears, as shown below.

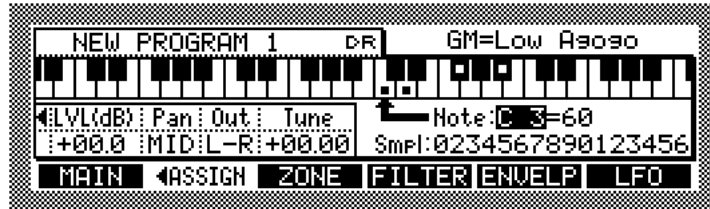

ASSIGN parameters are spread over two pages, which you can toggle between by pressing “ASSIGN,” or select by using the Right and Left CURSOR buttons.

3 Select the “Note” parameter, and then use the JOG dial to select the note to which you want to assign a Sample.

The keyboard graphic scrolls across the display as the “Note” parameter is changed. The arrow next to the “Note” parameter indicates the selected note. A small square dot appears on keys with Samples assigned to them, as shown in the example above.

When a note that is used by the Standard GM (General MIDI) drum kit is selected, the name of the GM drum assigned to that note appears in the upper right corner of the page. For notes that are not used by the GM drum kit, “Not Assigned” appears.

4 Select the “Smpl” parameter, then use the JOG dial to select a Sample.

5 Select the parameters and set them as required.

LVL: (–60.0 to +6.0) This sets the level of each Sample.

Pan: (L50–MID–R50) This sets the pan position of each Sample.

Out: (L/R, L, R, 1/2, 3/4, 5/6, 7/8, 1–8, MLT) The output of each Sample can be fed to the MAIN OUT, an individual left or right MAIN OUT, a pair of individual outputs (if IB-48P/IB-4ADT installed), or a single individual output (if IB-48P/IB-4ADT installed). When the parameter is set to “MLT,” if the Program is assigned to a Part in the currently selected Multi, the drum Sample’s output is fed to the output specified in that Part.

Tune: (–36.00 to +36.00) This sets the tuning for each Sample in semitone and cent steps.

You can use the PLAY button, or a connected MIDI keyboard to audition the changes as you make them. See “Configuring Programs” on page 49 for information on the MIDI settings necessary to play Programs.

6 Press “ASSIGN” to select the other ASSIGN page, or use the Right CURSOR button.

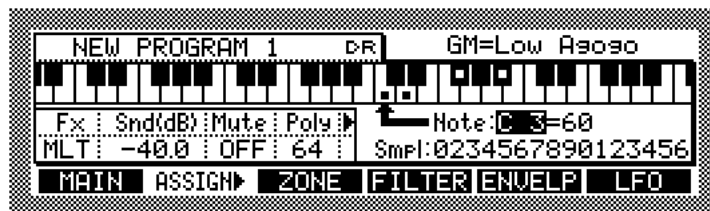

7 Select the parameters and set them as required.

Fx: (A, B, C, D, AB, CD, OFF, or MLT) When the parameter is set to “MLT,” if the Program is assigned to a Part in the currently-selected Multi, the settings specified for the Part is applied. If you wish to use the FX with only a certain Note, the FX output follows

the Keygroup's setting, not the Part's setting, even if the Program has been assigned to the Part.

Select "AB" or "CD" to use the FX with stereo inputs.

Snd(dB): This sets the FX Send level of each Sample.

In addition to assigning a Drum Sample to an FX Send, you must also configure the FX processors to use the FX. See "Using FX" on page 78 for more information.

Mute: (OFF, 1–64) This is used to add notes to Mute Groups. When a note in a Mute Group is played, any other notes in the same Mute Group are muted.

Poly: (1–64) This sets the maximum number of voices for each note.

Pressing the WINDOW button while the "Mute" parameter is selected opens the Mute Group window, shown below, which lists all of the notes assigned to the Mute Group selected at the top of the Window.

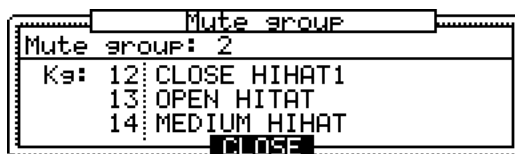

- 8 If you want to clear a Sample assignment, select the note to which the Sample is assigned, select the "Smpl" parameter, then rotate the JOG dial fully counterclockwise until the parameter displays a blank space.

Similar to Keygroup Programs, up to four drum Samples can be layered by using Zones. The layout of the ZONE, ZnMOD, and ZnTUNE pages is the same as that for Keygroup Programs, except instead of being able to select Keygroups in the upper-right corner of the page, you can select drum notes. See "Configuring Keygroup Programs" on page 51 for more information.

Configuring Program Modulation

Modulation for Keygroup and Drum Programs can be configured as follows.

- 1 On the KGRP page (ASSIGN page for Drum Programs), select the "Tune" or "Lvl" parameter, and then press the WINDOW button.

The Program Modulation window appears, as shown below. The Program Modulation window for Drum Programs is the same except that "Kg" is changed to "Key."

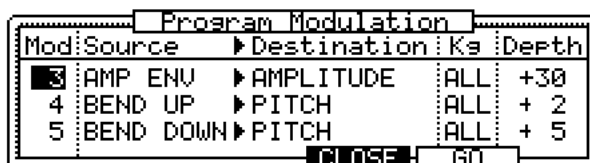

There are more than 30 modulation items that can be configured as either sources or destinations. One source can be assigned to multiple destinations, and multiple sources can be assigned to one destination. Modulation combination is set for the entire Program, although you can set the modulation depth for Keygroups individually.

- 2 Select the parameter, and use the JOG dial to set them as required.

Mod: Selects the assignable modulators.

Source: Selects the modulation source. The following sources can be selected: MOD WHEEL, BEND UP, BEND DOWN, AFT TOUCH, VELOCITY, OFF VELO, KEYBOARD, LFO1, LFO2, AMP ENV, FILT ENV, AUX ENV, CONTROLLER: (Control Changes can be assigned), EXT 1–8 (for use with the Q-Link controls), MODWHEEL, BEND UP, BEND DWN, EXT1-8, LFO1, LFO2, CTRL.

Modulation sources with a quarter-note (♩) use the modulation value at the time a key is pressed and ignore further changes. For example, when the “BEND” modulation source is selected, the sustained note changes as the bend wheel is moved. However, with the “♩BEND UP” modulation source, the sustained note does not change as the bend wheel is moved.

You can clear a source assignment by rotating the JOG dial fully counterclockwise until a blank space appears. When a “CTRL” source is selected, you can also select a MIDI Control Change for external control. The EXT 1–8 sources are for real-time control with the Q-Link controls. See “Using Q-Link” on page 75 for more information.

Destination: Selects the modulation destination. The following destinations can be selected: AMPLITUDE, PAN, PITCH, LFO1 RATE, LFO2 RATE, LFO1 DEPTH, LFO2 DEPTH, LFO1 DELAY, LFO2 DELAY, CUTOFF, RESONANCE, TF CUTOFF 1, TF RES 1, TF CUTOFF 2, TF RES 2, TF CUTOFF 3, TF RES 3, AMP ENV ATT, AMP ENV DEC, AMP ENV REL, FILT ENV R1, FILT ENV R4, AUX ENV R1, AUX ENV R4, ZONE SELECT, Z1 LEVEL, Z1 PAN, Z1 PITCH, Z1 START, Z1 FILT (same again for Zones 2–4).

The “Destination” parameter options that have a name starting with “TF” are effective only when you select “TRIPLE” for the “Filter Type” parameter on the FILTER page. Three filters can be controlled independently. If you select one of the “Destination” parameters that have a name starting with “Z,” you can control each Keygroup Zone independently.

You can clear a destination assignment by rotating the JOG dial fully counterclockwise until a blank space appears.

Kg: This is used to select the Keygroup whose modulation depth you want to set. When “ALL” is selected, you can set the depth of all Keygroups as a group. You can set the depth of “ALL” Keygroups simultaneously, then adjust individual Keygroups afterwards.

Depth: This sets the depth of each modulator for the Keygroup selected by the “Kg” parameter.

Press “GO” to display pages that contain the source or destination parameter. When an item in the Source column is selected, press “GO” to display the corresponding page, if any (e.g., the ENVELP pages). When an item in the Destination, Kg, or Depth column is selected, press “GO” to display the page that contains the corresponding parameter. For example, when CUTOFF is selected, press “GO” to display the FILTER page. When an LFO-related destination is selected, press “GO” to display the LFO page, and so on.

The followings are typical combinations of Program modulation:

VELOCITY > AMPLITUDE: Volume level is changed via velocity.

FILT ENV > CUTOFF: Cut-off frequency is changed via filter envelope.

LFO1 > PITCH: Vibrato effect is applied to pitch via LFO 1.

MODWHEEL > LFO 1 DEPTH: LFO 1 intensity can be changed via a keyboard’s modulation wheel.

AFTERTOUCH > LFO 1 DEPTH: LFO 1 intensity can be changed via a keyboard’s aftertouch.

AUX ENV > PITCH: Pitch envelope is applied via AUX envelope.

VELOCITY > ZONE SELECT: Samples to be played are switched via velocity.

You can make complicated Program modulation settings by combining multiple modulation items. In the combinations listed above, LFO 1 > PITCH combination adds vibrato effects to the pitch via LFO 1. Then, MODWHEEL > LFO 1 DEPTH enables you to adjust the intensity of LFO 1 via the modulation wheel. In this way, the intensity of vibrato changes when you operate the modulation wheel.

Renaming, Deleting, Copying, Merging, Purging & Converting Programs

Programs can be renamed, deleted, copied, merged, or converted from Keygroup to Drum type Programs and vice versa as follows. You can also purge (i.e., delete) all Samples or Programs in memory that are not assigned to any Programs or Multis.

- 1 **Select a Program as explained on page 48, and with the program name still selected, press the WINDOW button.**

The Program window appears, as shown below.



- 2 **To rename the selected Program, select the "Program name" parameter, and rotate the JOG dial to open the Name window.**

See "Entering Names" on page 17 for more information on using the Name window.

- 3 **To delete the selected Program, press "DELETE."**

The Delete Program window appears. Press "DO IT" to delete the selected Program, press "ALL" to delete all Programs in memory, or press "TAGGED" to delete all tagged Programs in memory.

- 4 **For the other functions, select the "Do" parameter and select "COPY," "MERGE," "PURGE SAMPLES," "PURGE PROGRAMS," or "CONVERT," then press "DO IT."**

If you selected "COPY" and press "DO IT," the Copy Program window appears. Select the "New name" parameter, and rotate the JOG dial to open the Name window. Enter a name for the new Program, and then press "DO IT."

If you selected "MERGE," the Merge Programs window appears. Use the "Source" parameter to select the Program that you want to merge with the current program. Select the "New name" parameter, and rotate the JOG dial to open the Name window. Enter a name for the new Program, and then press "DO IT." The settings of the selected Program are used in the newly merged Program. If you merge a Drum Program with a Keygroup Program, the newly merged Program type is determined by the selected Program.

If you selected "PURGE SAMPLES," the Purge window appears, displaying the number of Samples in memory that are not assigned to any Programs in memory. Press "DO IT" to delete these Samples.

If you selected "PURGE PROGRAMS," the Purge window appears, displaying the number of Programs in memory that are not assigned to any Multis in memory. Press "DO IT" to delete these Programs.

If you selected "CONVERT," the Convert Program window appears. Select the "New name" parameter, and rotate the JOG dial to open the Name window. Enter a name for the new Program, and then press "DO IT."

When a Drum Program is converted to a Keygroup Program, the Sample assigned to each note is assigned to a Keygroup with the Keyspan "Lo" and "Hi" parameters set the same as that note. Therefore, the converted Program will play exactly the same. When a Keygroup Program is converted to a Drum Program, each Sample is assigned to the note specified by its Keygroup's "Lo" parameter.

Configuring Program MIDI Options

The MIDI options for Keygroup and Drum Programs can be configured as follows.

1 Select a Program as explained on page 48, and then press “MIDI.”

The MIDI page appears, as shown below.

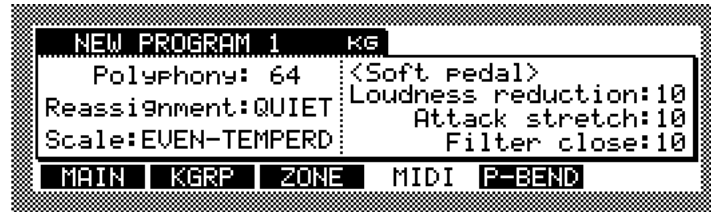

2 Select the parameters, and use the JOG dial to set them.

Polyphony: (1–64) This can be used to limit the maximum number of voices that a Program can play simultaneously.

Reassignment: (QUIET, OLDEST) This determines how voices are reassigned when the limit set by the Polyphony parameter is reached. When set to “QUIET,” voices are stolen from the quietest notes first. When set to “OLDEST,” voices are stolen from the oldest notes first.

Scale: (USER, EVEN-TEMPERED, ORCHESTRAL, WERKMEISTER, 1/5 MEANTONE, 1/4 MEANTONE, JUST, ARABIAN) This selects the keyboard scale.

When you press the WINDOW button while the “Scale” parameter is selected, the Program Scale window opens, as shown below, which allows you to view the selected scale and create your own scale.

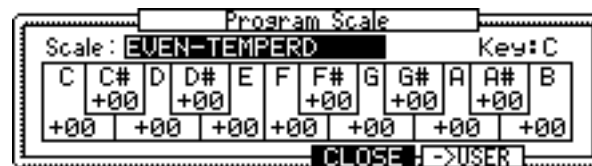

To create a custom scale, Use the “Scale” parameter to select a preset scale, then press “->USER” to open the Copy Scale window. Press “DO IT” to copy that scale to the User Scale. Select the keys and use the JOG dial to set the note intervals as required. Press “CLOSE” to save your settings as the USER scale.

Loudness reduction: This determines the degree of level reduction that is applied when a MIDI Soft Pedal message is received.

Attack stretch: This sets the attack time delay for when a MIDI Soft Pedal message is received.

Filter close: This determines the degree of Filter closure that is applied when a MIDI Soft Pedal message is received.

Pressing the WINDOW button while a parameter other than “Scale” (or the Program name) is selected opens the MIDI Monitor window, shown below, which indicates MIDI reception activity for the 32 MIDI Channels.

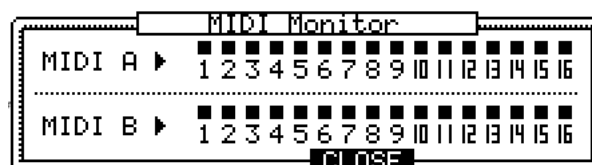

Configuring Pitch Bend

Bend wheel operation for Keygroup and Drum Programs can be configured as follows.

- 1 **Select a Program as explained on page 48, and then press “P-BEND.”**

The Pitch Bend page appears, as shown below.

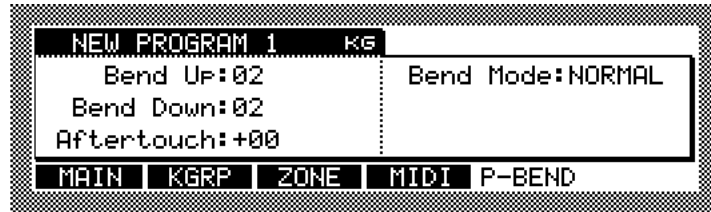

- 2 **Select the parameters, and use the JOG dial to set them.**

Bend Up/Bend Down: (0–24) These determine the maximum amount of pitch bend when the bend wheel is moved fully up and down.

Aftertouch: (–12 to +12) This determines the maximum amount of pitch bend when aftertouch is applied.

Bend Mode: (NORMAL, HELD) This determines how pitch bend is applied. When set to “HELD,” pitch bend is applied relative to the position of the bend wheel at the time notes are played. However, note pitch is not affected by subsequent bend wheel movements (i.e., the pitch is held). When set to “NORMAL,” the pitch changes as the bend wheel is moved.

Configuring the LFOs

The LFO1 and LFO2 of each Keygroup, or Drum sample note, can be configured as follows.

- 1 **Select a Program as explained on page 48, press “KGRP” (“ASSIGN for Drum Programs), and then press “LFO.”**

The LFO page appears, as shown below.

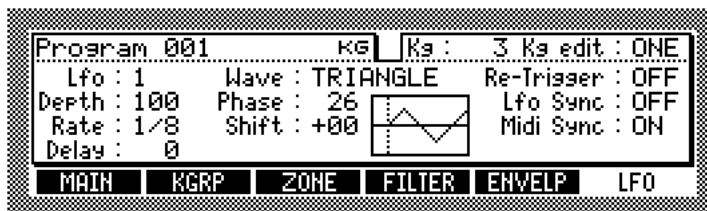

- 2 **Select the “LFO” parameter, and use the JOG dial to select LFO1 or LFO2. Alternatively, press “LFO” to toggle between LFO1 and LFO2.**

The page layout and parameters for LFO1 and LFO2 are the same.

- 3 **Select the “Kg” parameter, and use the JOG dial to select a Keygroup.**

For Drum Programs, instead of the “Kg” and “Kg edit” parameters, you can select individual drum Sample notes.

You can edit the LFO1 or LFO2 of individual Keygroups or all Keygroups simultaneously by setting the “Kg edit” parameter. When set to “ONE,” edits apply to only the selected Keygroup. When set to “ALL,” edits apply to all Keygroups absolutely. So if the Delay of one Keygroup is set to “10,” the Delay of all Keygroup are set to “10.” When set to “ADD,” edits apply to all Keygroups relatively. So if Keygroup #1 has a Delay of “50,” and Keygroup #2 has a Delay of “30,” increasing the Delay of any Keygroup by “10” will change the Delay of Keygroup #1 to “60,” and that of Keygroup #2 to “40.”

- 4 **Select the parameters, and use the JOG dial to set them.**

Depth: (0–100) This determines the LFO depth.

Rate: (0–100) This determines the LFO speed. When the “Midi Sync” parameter is set to “ON,” the rate is synchronized to the incoming MIDI Clock information and this parameter can be used to set the number of oscillator cycles per beat: 1/8, 1/6, 1/4, 1/2, or 1–64.

Delay: (0–100) This determines the LFO delay time.

Wave: (TRIANGLE, SINE, SQUARE, SAW UP, SAW DOWN, RANDOM) This selects the LFO waveform. The current waveform is displayed graphically.

Phase: (0–360) This determines the start phase of the LFO waveform, “360” being one complete cycle. The current start phase is displayed on the waveform by a vertical dotted line.

Shift: This offsets the center of the LFO waveform.

Re-Trigger: (ON, OFF) This determines how the LFO is retriggered when subsequent notes are played. When set to “ON,” the LFO restarts each time a new note is played. When set to “OFF,” the same LFO waveform is applied to subsequent notes.

Lfo Sync: (ON, OFF) When set to “ON,” the LFOs of all voices are synchronized. all LFOs are synchronized.

Midi Sync: (ON, OFF) When set to “ON,” the LFO speed is synchronized to the incoming MIDI Clock information, and the Rate parameter can be used to specify the number of oscillator cycles per beat.

You will need to configure Program Modulation for controls via the LFOs. Press the WINDOW button while a parameter other than the Program name is selected to open the Program Modulation window. See “Configuring Program Modulation” on page 58 for more information.

Configuring the Filters

The Filter of each Keygroup, or Drum Program note, can be configured as follows.

- 1 **Select a Program as explained on page 48, press “KGRP” (“ASSIGN for Drum Programs), and then press “FILTER.”**

The FILTER page appears, as shown below.

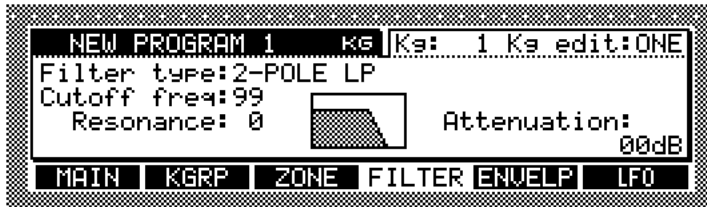

- 2 **Select the “Kg” parameter, and use the JOG dial to select a Keygroup.**

For Drum Programs, instead of the “Kg” and “Kg edit” parameters, you can select individual drum Sample notes.

You can edit the Filters of individual Keygroups or all Keygroups simultaneously by setting the “Kg edit” parameter. See “Configuring the LFOs” on page 63 for more information.

- 3 **Select the parameters, and use the JOG dial to set them.**

Filter type: The following Filter types can be selected: OFF, 2-POLE LP, 2-POLE LP+, 4-POLE LP, 4-POLE LP+, 6-POLE LP, 2-POLE BP, 2-POLE BP+, 4-POLE BP, 4-POLE BP+, 6-POLE BP, 1-POLE HP, 1-POLE HP+, 2-POLE HP, 2-POLE HP+, 4-POLE HP, 4-POLE HP+, 6-POLE HP, LO<>HI, LO<>BAND, BAND<> HI, NOTCH 1, NOTCH 2, NOTCH 3, WIDE NOTCH, BI-NOTCH, PEAK 1, PEAK 2, PEAK 3, WIDE PEAK, BI-PEAK, PHASER 1, PHASER 2, BI-PHASE, VOWELISER, TRIPLE.

The Filter types marked with a “+” feature enhanced resonance.

Cutoff freq: (0–100) This sets the cutoff frequency of each Filter.

Resonance: (0–64) This sets the resonance of each Filter.

Attenuation: (0–30) This allows you to adjust the headroom of the Filter Amps in order to reduce the risk of distortion when resonance is applied.

When Filter type is set to “TRIPLE,” three 2-pole filters can be configured individually, as shown below.

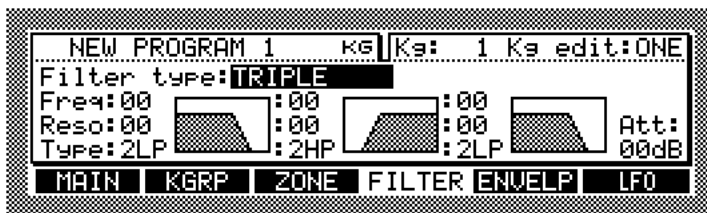

- 4 **Select the parameters, and use the JOG dial to set them.**

Freq: This sets the cutoff frequency of each Filter.

Reso: This sets the resonance of each Filter.

Type: The following Filter types can be selected: 2LP, 2HP, 1HP, 1BP, NOTCH, EQ, EQ+, or OFF.

Att: This allows you to adjust the headroom of the Filter Amps in order to reduce the risk of distortion when resonance is applied.

Configuring the Amp, Filter & Aux Envelopes

The envelopes for each Keygroup, or Drum Program note, can be configured as follows.

- 1 **Select a Program as explained on page 48, press “KGRP” (“ASSIGN for Drum Programs), and then press “ENVELP.”**

The ENVELP page appears, as shown below.

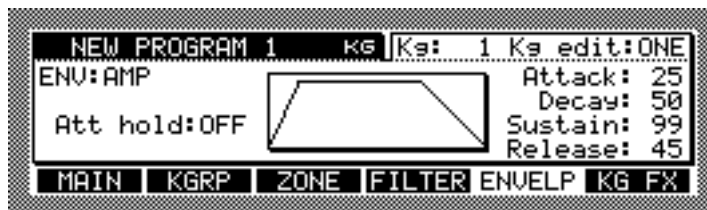

- 2 **Select the “Kg” parameter, and use the JOG dial to select a Keygroup.**

For Drum Programs, instead of the “Kg” and “Kg edit” parameters, you can select individual drum Sample notes.

You can edit the Envelope for individual Keygroups, or for of all Keygroups simultaneously by setting the “Kg edit” parameter. See “Configuring the LFOs” on page 63 for more information.

- 3 **Select the “ENV” parameter, and use the JOG dial to select the Envelope. Alternatively, press “ENVELP” to toggle between the Envelopes.**

There are three types of Envelope: Amp (mainly used for level controls), Filter (mainly used for Filter Envelopes), and Aux (mainly used for pitch Envelopes).

The parameters for each Envelope are explained below.

- 4 **Select parameters, and use the JOG dial to set them.**

This is the Amp Envelope page.

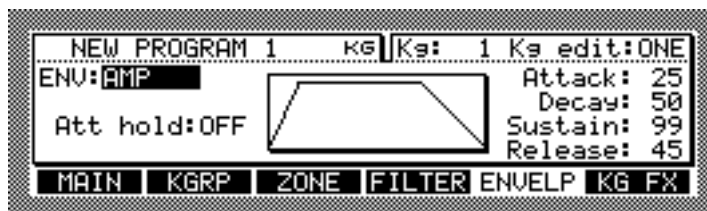

Att hold: (ON, OFF) When set to “ON,” decay begins at the Loop Start point for Samples that are set to loop.

Attack: (0–100) This determines the attack time.

Decay: (0–100) This determines the decay time.

Sustain: (0–100) This determines the sustain level.

Release: (0–100) This determines the release time.

This is the Filter Envelope page.

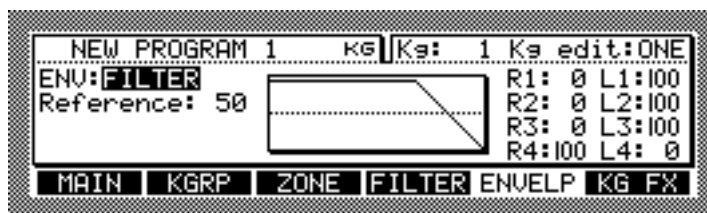

Reference: The settings are indicated by the horizontal dotted line in the Envelope display. For example, when used as a Filter Envelope, if the Reference value is the same as the L3 value (center example), the cutoff frequency during the sustain phase is applied as originally set. If the Reference value is higher than that of L3 (left example), the cutoff frequency will be lower than that specified on the FILTER page. This also applies to pitch Envelopes (i.e., if Reference is the same as L3, Samples will play at their original pitch).

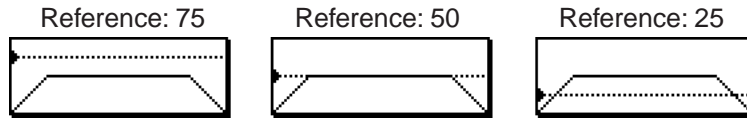

R1–R4: These are the time settings for the four points.

L1–L4: These are the level settings for the four points.

You will need to select **FILT ENV > CUTOFF** in the Program Modulation window to control the Filters via the FILTER envelope. See “Configuring Program Modulation” on page 58 for more information.

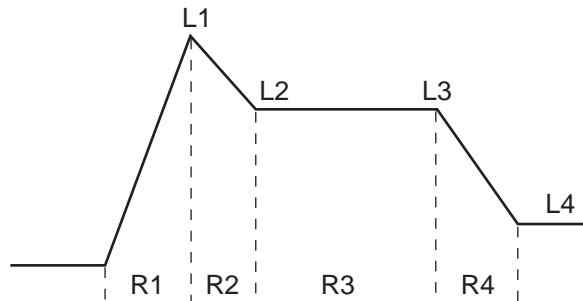

This is the Filter Aux page.

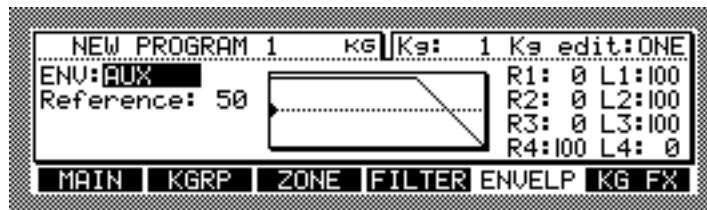

The other parameters are the same as those on the Filter Envelope page.

You will need to configure Program Modulation for controls via the AUX envelope. See “Configuring Program Modulation” on page 58 for more information.

8 Using Multis

About Multi Mode

This chapter explains how to create and edit Multis in Multi mode.

Selecting Multis

Multis are selected as follows.

1 Press the MULTI button.

The MULTI button indicator lights up and the SELECT page appears.



2 Use the JOG dial to select a Multi.

If there are no Multis in memory, the message "(no multi)" appears, as shown below.



3 If you want to view a list of Multis in memory, press the WINDOW button.

The Multi List window appears, as shown below.

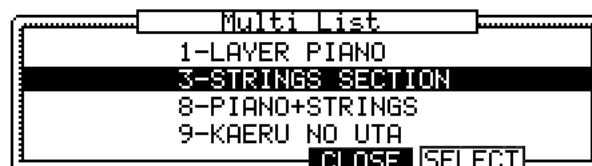

The Multis in memory are listed in the order of their MIDI Program Change number, which is displayed next to each Multi name.

4 Use the JOG dial to select a Multi, then press "SELECT."

Only Multis already in memory can be selected. To select a Multi stored on a storage device, you must load it first. See "Loading" on page 18 for more information.

Creating Multis

Multis can be created as follows.

- 1 Press the **MULTI** button, then select the **MAIN** page shown below.

		Lvl(kdB)	Pan	Out	Ch	No.
1-Multi 1						
1	SYNTH BASS	+000	MID	L-R	1A	OFF
2	TRAD. E.PF	+000	MID	L-R	2A	OFF
3	LEGATO VLSH	+000	MID	L-R	3A	OFF
4	CELLO 1	+000	MID	L-R	4A	OFF

SELECT MAIN TUNE FX MUTE SOLO

- 2 Select the **Multi** parameter that indicates the Multi name in the upper left corner, then press the **WINDOW** button.

The Multi window appears, as shown below.

Multi	
Multi Name :	Multi 1
Multi Change Number :	OFF
Multi Select :	OFF
Multi Select Channel :	1A

DELETE NEW CLOSE COPY

To rename an existing Multi, select the “Multi name” parameter, rotate the JOG dial to open the Name window. See “Entering Names” on page 17 for more information on using the Name window. The “Multi change number” parameter determines the number that will be used to select the Multi via MIDI Program Change. The “Multi select” parameter determines how Multis are selected via MIDI. When set to “PROG CHANGE,” Multis can be selected by using MIDI Program Change messages. When set to “BANK CHANGE,” Multis can be selected by using MIDI Bank Change messages. When set to “OFF,” Multis cannot be selected via MIDI. The “Multi select channel” parameter determines which MIDI Channel is to be used for selecting multis.

- 3 Press **“NEW.”**

The Create New Multi window appears, as shown below.

Create New Multi	
New Name :	Multi 2
Pressing DI IT will create a new Multi.	

CLOSE DO IT

- 4 Select the **“New name”** parameter, then rotate the **JOG** dial.

The Name window opens. See “Entering Names” on page 17 for more information.

- 5 Press **“DO IT.”**

A new Multi is created.

Assigning Programs to Parts

A Multi can contain up to 128 Parts, and you can assign one Program to each Part.

1 Select a Multi, as explained on page 67.

2 Press “MAIN.”

The MAIN page appears, as shown below.

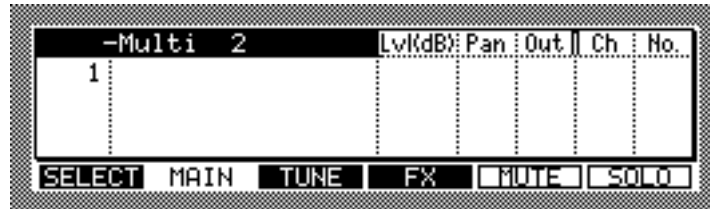

New Parts can be created as follows.

3 Select the Part number parameter, then press the WINDOW button.

The Part window appears, as shown below.



In addition to creating new Parts, you can delete (DELETE) existing Parts and sort (ARRANG) Parts by MIDI channels from this window.

4 Press “CREATE.”

The Create New Part window appears, as shown below.



5 Use the JOG dial to specify the number of new Parts that you want to create.

6 Press “DO IT.”

The specified number of Parts are created. More Parts can be created at any time.

7 Select the Part number parameter, then use the JOG dial to select a Part, as shown in the example below.

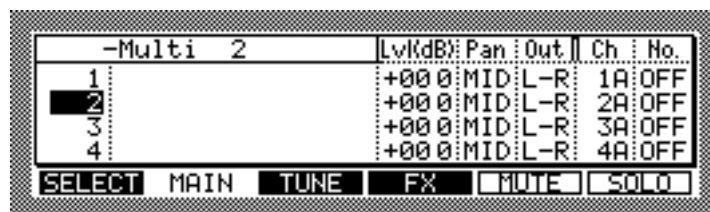

- 8 Select the Program name column, then use the JOG dial to select a Program, as shown in the example below.

-Multi 2		Lvl(kdB)	Pan	Out	Ch	No.
1	SYNTH BASS	+00 0	MID	L-R	1A	OFF

SELECT MAIN TUNE FX MUTE SOLO

Only Programs already in memory can be selected. See page 18 for information on loading Programs.

You can set the level, pan, output, MIDI Channel, and MIDI Program Change for Parts as follows.

- 9 Select the parameters for the Part you want to configure, then use the JOG dial to set them as required.

Lvl: (–60.0 to +6.0) This parameter sets the output level of the Part.

Pan: (L50–MID–R50) This parameter sets the pan position of the Part.

Out: (L/R, L, R, 1/2, 3/4, 5/6, 7/8, 1–8) The output of each Part can be fed to the MAIN OUT, an individual left or right MAIN OUT, a pair of individual outputs (if IB-48P/IB-4ADT installed), or a single individual output (if IB-48P/IB-4ADT installed).

Ch: (1A–16A, 1B–16B) When set to 1A–16A, the Part will respond to MIDI data on channel 1–16 of the MIDI IN A port. When set to 1B–16B, the Part will respond to MIDI data on channel 1–16 of the MIDI IN B port.

Note that all Parts assigned to the same MIDI Channel will play together.

No: (OFF, 1–128) This displays the MIDI Program Change number that was assigned to the Part's Program in Program mode.

- 10 Press "TUNE."

The TUNE page appears, as shown below.

-Multi 2		Tune	LO > HI	Priority
1	SYNTH BASS	+00.00	C-2 G 8	NORM

SELECT MAIN TUNE FX MUTE SOLO

- 11 Select the parameters for the Part you want to configure, then use the JOG dial to set them as required.

Tune: (–36.00 to +36.00) This sets the tuning for each Part in semitone and cent steps.

Lo > Hi: (C-2 to G8) This sets the keyspan for each Part.

Priority: (HOLD, HIGH, NORM, LOW) This sets the voice priority for each Part, which determines how voices are allocated when all voices are being used. Voices are stolen from Parts with a low priority and assigned to Parts with a higher priority.

When a MIDI message is received by the Z8, a small square will appear next to any Part number that is set to the same MIDI channel as the message, as shown in the example below.

MIDI receive indicator

3-WS #2		Lvl	Pan	Out	Ch	No.
1	SYNTH BASS	57	MID	L/R	1A	OFF
2	TRAD. E.FF	99	L40	1/2	10B	OFF
3	TRAD. E.FF	20	500	5	50	ACC

New Multis, or Multis that have been edited, have an asterisk next to their name if they have not yet been saved.

If you want to keep your edited Multis for future use, save them to disk. See “Saving” on page 84 for more information.

The currently selected Part can be muted by pressing “MUTE.” Press “MUTE” again to unmute the Part. Multiple Parts can be muted. The “MUTE” button flashes while the Mute function is active. The letter “M” appears in the Part number column of Parts that are muted, as shown below.

```
|M| 1|SYNTH BASS| 57|MID|L/R|| 1A|OFF|
```

The currently selected Part can be soloed by pressing “SOLO.” All other Parts are muted. Press “SOLO” again to unsolo the Part. Multiple Parts can be soloed. Even muted Parts can be soloed. The “SOLO” button flashes while the Solo function is active. The letter “S” appears in the Part number column of Parts that are soloed, as shown below.

```
|S| 1|SYNTH BASS| 57|MID|L/R|| 1A|OFF|
```

Filtering MIDI Data

You can filter various types of MIDI messages independently for each of MIDI Channels 1A-16A and 1B-16B, as follows:

- 1 Select a Multi, as explained on page 67.

- 2 Press “MAIN.”

The MAIN page appears.

- 3 Select the “Ch” parameter, then press the WINDOW button.

The MIDI Filter List window appears, as shown below.



The “Chan” parameter indicates the currently-selected MIDI channel number.

- 4 Use the JOG dial or CURSOR buttons to select the individual filters, and press “PASS” to set them.

- ✓ MIDI message received.
- × MIDI message ignored.

Press “ALL” to set all filters to receive MIDI messages. Press “ON/OFF” to enable and disable the MIDI filter.

Applying FX to Parts

Parts can be routed to the internal FX as follows.

- 1 **Select a Multi, as explained on page 67.**
- 2 **Press “FX.”**

The FX page appears, as shown below.

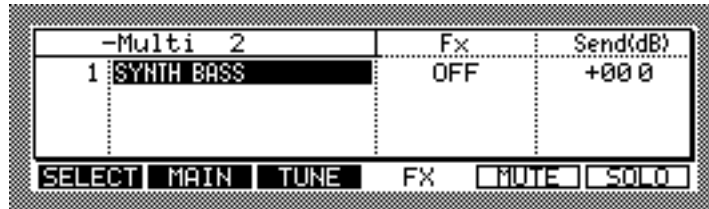

- 3 **Select a parameter of the Part you wish to set, and use the JOG dial to set the parameter.**

Fx: A, B, C, D, AB, CD, OFF) Use the JOG dial to select on of the options. The output of each Part can be fed to an individual FX Send, a pair of FX Sends, or switched off. The FX type for each FX processor is set in FX mode. See “Using FX” on page 78 for more information.

Note that the “AB” and “CD” options are intended for adding FX to stereo Samples.

Note that a Keygroup’s FX settings in Program mode must be set to “MULTI,” for the settings on the FX page to work. See “Configuring Keygroup Programs” on page 51 for more information.

Send(dB): Use the JOG dial to set the FX Send level.

Copying Multis

Multis can be copied as follows.

- 1 **Press the MULTI button, then select the MAIN page shown below.**

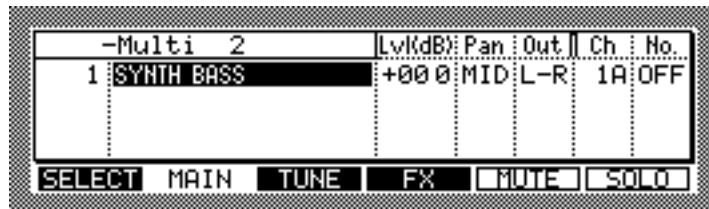

- 2 **Press the WINDOW button.**

The Multi window appears, as shown below.

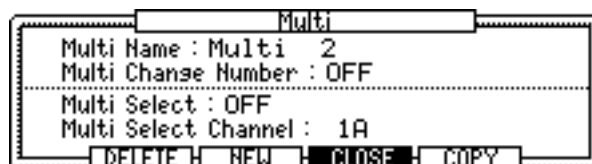

- 3 **Press “COPY.”**

The Copy Multi window appears, as shown below.

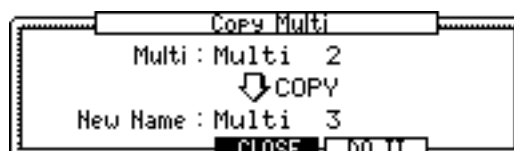

- 4 Select the “Multi” parameter, then use the JOG dial to select a Multi to copy.
- 5 Select the “New name” parameter, then rotate the JOG dial.
The Name window opens. See “Entering Names” on page 17 for more information.
- 6 Press “DO IT.”
The selected Multi is copied.

Deleting Multis

Multis can be deleted as follows.

- 1 Press the MULTI button, then select the MAIN page shown below.

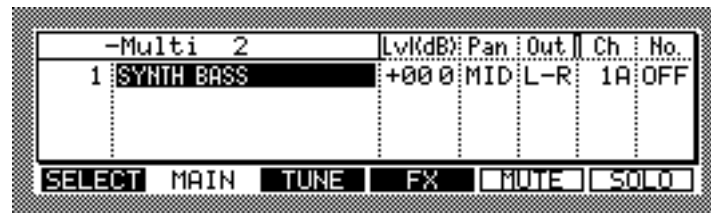

- 2 Select the Multi name in the upper left corner, then use the JOG dial to select a Multi you wish to delete.
- 3 Press the WINDOW button.

The Multi window appears, as shown below.

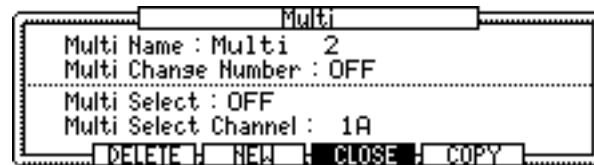

- 4 Press “DELETE.”

The Delete Multi window appears, as shown below.



The “Multi” parameter indicates the Multi to be deleted.

- 5 Press “DO IT” to delete the selected Multi, or press “ALL” to delete all Multis in memory. Alternatively, press “TAGGED” to delete only the tagged Multis.

The selected Multi is deleted. If you pressed “ALL,” the Delete ALL Multi window appears. Press “DO IT” to delete all Multis. If you pressed “TAGGED,” the Delete ALL Tagged Multis window appears. Press “DO IT” to delete the tagged Multis.

Playing Songs

SMF (Standard MIDI File) sequence data can be played on the Z8 as follows.

- 1 Press “SONG” on the SELECT page in Multi mode.

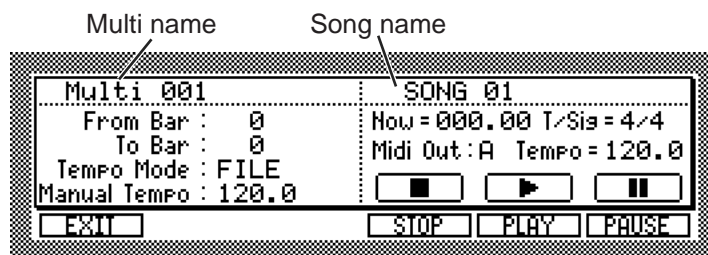

You will need to select a Song in this window to play the Song.

- 2 Select the song parameter, then use the JOG dial to select a song.

Only Songs already in memory can be selected. See page 18 for information on loading Songs.

Songs can be deleted by using the Song List window, which is accessed by pressing the WINDOW button.

- 3 Set the other parameters as required.

From Bar: This determines the bar from which playback starts.

To Bar: This determines the bar at which playback ends.

Tempo mode: (FILE, MANUAL) This parameter determines the source of the tempo information. When set to “FILE,” the tempo information in the MIDI Song File is used. When set to “MANUAL,” the “Manual Tempo” parameter setting is used.

Manual Tempo: This sets the tempo when the Tempo mode is set to “MANUAL.” This value cannot be changed when the Tempo mode is set to “FILE.”

Now: This is the bar and beat counter.

T/sig: This indicates the time signature.

MIDI out: (A, B, OFF) This determines which set of MIDI Channels (A or B) are used for song playback.

Tempo: This indicates the current tempo.

- 4 Press “PLAY” to start playback.

Press “STOP” or “PAUSE” to stop or pause playback.

Press “EXIT” to return to the SELECT page.

9 Using Q-Link

About Q-Link

You can control up to eight Part or FX parameters (four on the Z4) in real time by using the front panel Q-Link controls. Each control can be assigned to one Part or FX parameter, or to the same parameter in all Parts. Each Multi can have its own Q-Link assignments. In addition, the Q-Link controls can be configured so that they transmit MIDI Control Change messages as they are adjusted, which can be recorded to an external MIDI sequencer.

Configuring Q-Link

Q-Link can be configured as follows.

- 1 Select a Multi, as explained on page 67.
- 2 Press the Q-Link button, and then select the ASSIGN page shown below.

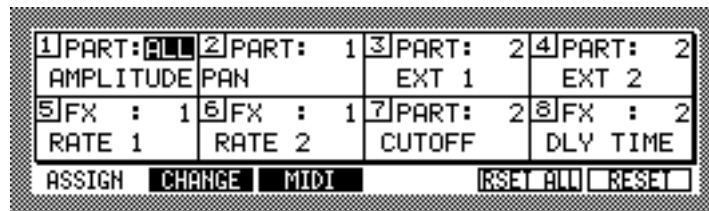

The Q-Link ASSIGN page is divided into eight sections, one for each Q-Link control.

- 3 Select the word “Part” (or “FX”), and use the JOG dial to select “Part” or “FX” for the Q-Link control.

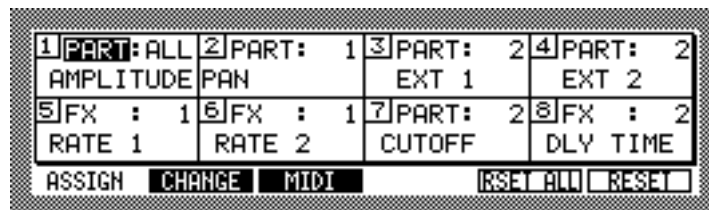

- 4 If you selected “Part,” select the “Part” parameter field and specify the number of the Part that is to be controlled by the selected Q-Link control.
1–128 or ALL: When ALL is selected, the specified parameter becomes effective in all Parts. In the case of FX, you can select an FX processor.
- 5 Select the parameter of the Q-Link control that you want to configure, as shown in the example below.

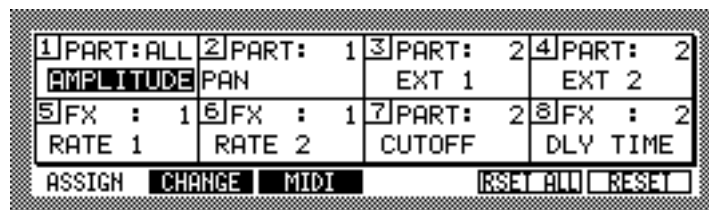

6 Use the JOG dial to select a parameter

When “Part” is selected, you can select parameters that are available to Program modulation sources (e.g., Amplitude, Pan, Cutoff, and so on), EXT 1–8, or OFF. When EXT 1–8 is selected, only the modulation destinations (for which EXT 1–8 are assigned as the source) are affected.

In the case of FX, you can select the parameters of the FX type currently assigned to each FX. See “Selecting FX Types” on page 79 for more information.

Press “RESET” to reset the parameters that are controlled by the selected Q-LINK to their original values. Press “RESET ALL” to reset the parameters that are controlled by all Q-LINKs to their original values.

You can specify how much control the Q-Link controls exert over the assigned parameters on the CHANGE page.

7 Press “CHANGE.”

The CHANGE page appears, as shown below.

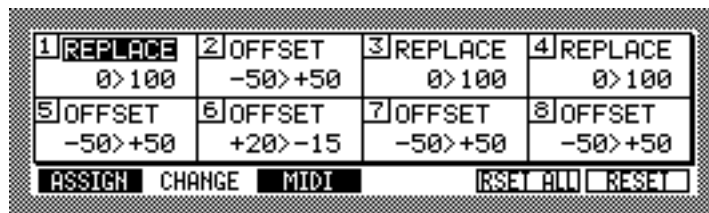

8 Select the Replace/Offset parameter for the Q-Link control that you want to configure, as shown in the example above.

9 Use the JOG dial to select either of the following options:

REPLACE: Adjustments made by using the Q-Link control are absolute, which means that they ignore the parameter’s original setting.

OFFSET: Adjustments made by using the Q-Link control are relative to the parameter’s original setting.

10 Select the first range parameter for the Q-Link control that you want to configure, and use the JOG dial to set it, as shown in the example below.

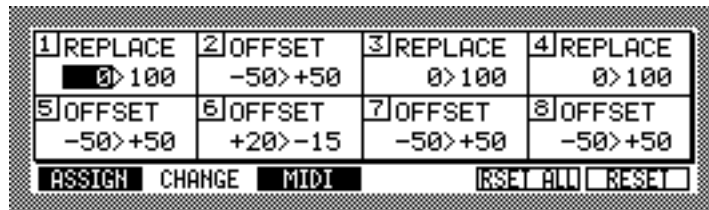

If REPLACE is selected, you can specify the control range from –100 to +100. If the range is set to, for example, “0>50”, the minimum position of the Q-Link control (when the control is turned all the way to the left) is 0, while the maximum position (when the control is turned all the way to the right) is 50. With a setting of, for example, “100>0,” the minimum position of the Q-Link control is 100, while the maximum position is 0.

If OFFSET is selected, you can specify the control range from –100 to +100. If the range is set to, for example, “–25>+25”, the minimum position of the Q-Link control is –25, while the maximum position is +25. With a setting of, for example, “+25>–25,” the minimum position of the Q-Link control is +25, while the maximum position is –25.

- 11 Select the second range parameter for the Q-Link control that you want to configure, and use the JOG dial to set it, as shown in the example below.

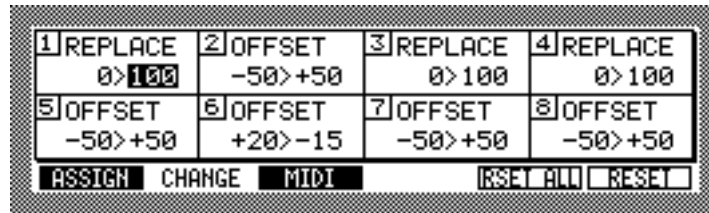

You can assign MIDI Control Changes to the Q-Link controls on the MIDI page.

- 12 Press “MIDI.”

The MIDI page appears, as shown below.

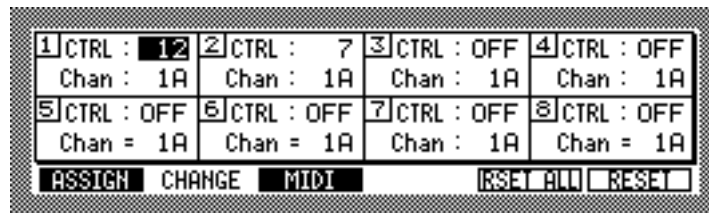

- 13 Select the “CTRL” parameter for the Q-Link control that you want to configure, and then use the JOG dial to select a MIDI Control Change.

0-127 or OFF: Selects the MIDI Control Change that will be transmitted when the Q-Link control is adjusted. No Control Change messages are transmitted when “OFF” is selected.

Control Change messages are transmitted on the MIDI Channel assigned to the Part. See “Assigning Programs to Parts” on page 69.

When a Q-Link control is assigned to control “ALL” (i.e., all Parts), Control Change messages are transmitted on the MIDI Channel assigned to the “Multi select channel” parameter on the Multi window.

When an FX processor is assigned to a Q-Link control, you can select the MIDI Channel that is used to transmit the Control Change messages.

When Control Change messages recorded by a MIDI sequencer are played back and received by the Z8, they are interpreted in accordance with the current ASSIGN and CHANGE page settings. For example, suppose that Q-Link control 1 is assigned to the Cutoff parameter of Part 1 and set as follows: “REPLACE” and “0>100.” And then Q-Link 1 control adjustments are recorded to a MIDI sequencer. If the REPLACE range is set to “0>50” when the MIDI sequence is played back, the Cutoff parameter will open only half way. Likewise, if the parameter assigned to Q-Link control 1 is changed from Cutoff to Resonance, the Resonance parameter will be adjusted instead.

10 Using FX

About the FX

This chapter explains how to configure the Z8's four FX processors (optional on the Z4). Programs and Multis can be routed to the FX via the FX Send buses A–D. See “Configuring Keygroup Programs” on page 51 and “Applying FX to Parts” on page 72 for more information. FX processors can be linked for use with stereo Samples, or connected in series. FX settings are stored in Multis.

Configuring FX Inputs

The input source for each FX processor can be set as follows.

1 Press the FX button.

The FX button indicator lights up and the PATCH page appears.

Input	FX Type	Output
SEND A	▶1 DISTORTION	▶OFF
FX 1	▶2 REVERB>STUDIO	▶L-R
SEND B	▶3 DELAY>STEREO	▶L-R
SEND B	▶4 REVERB>BIG ROOM	▶1-2

PATCH EDIT MIX

2 In the “Input” column, select the Input parameter for the FX processor whose inputs you want to configure, and use the JOG dial to select one of the following options.

SEND A–D: Selects FX Send A, B, C, or D as the input source. The same FX Send can be selected for one or more FX processors.

FX 1–4: Selects the output of FX processor 1–4 as the input source, allowing you to connect FX in series. Since the input to each FX processor is mono, and the output is stereo, the output of the preceding FX processor is mixed into mono before being fed to the subsequent FX processor, as shown below.

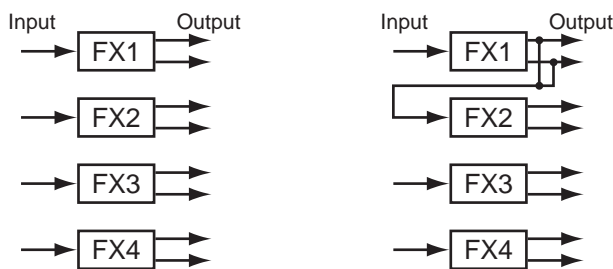

Note: While Sample recording is in progress, FX4 does not feed its output signal to any of the outputs. However, if it's used in series, its output signal is fed to the subsequent FX processor.

In the following example, FX1 and FX2 apply distortion and reverb in series to the signal routed from Send A. The output of FX1 is set to “OFF.” The input source for FX2 is set to “FX1.” Samples routed to Send A are processed by FX1 (distortion), whose output is fed to the input of FX2 (reverb), the output of which is fed to L-R.

Input	FX Type	Output
SEND A	▶1 DISTORTION	▶OFF
FX 1	▶2 REVERB>STUDIO	▶L-R

Configuring FX Outputs

The output of each FX processor can be set as follows.

1 Press the FX button.

The FX button indicator lights up and the PATCH page appears.

Input	FX Type	Output
SEND A	▶1 DISTORTION	▶OFF
FX 1	▶2 REVERB>STUDIO	▶L-R
SEND B	▶3 DELAY>STEREO	▶L-R
SEND B	▶4 REVERB>BIG ROOM	▶1-2

PATCH EDIT MIX

2 In the “Output” column, select the Output parameter of the FX processor whose output you want to configure, and use the JOG dial to select one of the following options.

OFF, L-R, 1-2, 3-4, 5-6, 7-8, L, R, or 1-8: The output of each FX processor can be fed to the MAIN OUT, an individual left or right MAIN OUT (L-R), a pair of individual outputs (if IB-48P installed), or a single individual output (if IB-48P installed). When “OFF” is selected, the FX processor output is not fed to any of the outputs, which is useful when FX are connected in series.

In the following configuration example, FX3 and FX4 provide delay and reverb in series. The input source for FX4 is set to “FX3.” Samples routed to FX Send B are processed by FX3 (delay), whose output is fed to both L-R and the input of FX4 (reverb), the output of which is also fed to L-R.

SEND B	▶3 DELAY>STEREO	▶L-R
FX 3	▶4 REVERB>BIG ROOM	▶1-2

Selecting FX Types

The FX type for each FX processor can be selected as follows.

1 Press the FX button.

The FX button indicator lights up and the PATCH page appears.

Input	FX Type	Output
SEND A	▶1 DISTORTION	▶OFF
FX 1	▶2 REVERB>STUDIO	▶L-R
SEND B	▶3 DELAY>STEREO	▶L-R
SEND B	▶4 REVERB>BIG ROOM	▶1-2

PATCH EDIT MIX

2 In the “FX Type” column, select the FX processor for which you want to set the FX type.

3 Rotate the JOG dial.

The Select Effect window appears, as shown below.

Select Effect
DELAY>XOVER
DIGITAL EQ
DISTORTION
ENHANCER

CANCEL SELECT

4 Use the JOG dial to choose an FX type, and then press “SELECT” to select it.

See page 82 for a complete list of available FX types.

Linking FX

FX1 and FX2, or FX3 and FX4 can be linked together for use with stereo Samples. Normally each FX processor has a mono input and stereo output. Linked FX, however, have a stereo input and stereo output.

1 Press the FX button.

The FX button indicator lights up and the PATCH page appears.

Input	FX Type	Output
SEND A	▶1 DISTORTION	▶L-R
SEND B	▶2 REVERB>STUDIO	▶L-R
SEND C	▶3 DELAY>STEREO	▶L-R
SEND D	▶4 REVERB>BIG ROOM	▶L-R
PATCH EDIT MIX		

2 To link FX1 and FX2, select the “Input” or “Output” parameter of FX1 or FX2 parameter, and press the WINDOW button. (To link FX3 and FX4, select the parameter of FX3 or FX4).

The Stereo Link On window appears.

3 Press “DO IT” to link the selected FX.

The left channel of stereo Samples is fed to FX1/FX3, the right channel is fed to FX2/FX4.

When FX are linked, the “FX Type” and “Output” parameters are set by FX1/FX3. The “Output” parameter for FX2/FX4 cannot be set. The “FX Type” parameter for FX2/FX4 appears as “STEREO LINKED,” as shown below.

Input	FX Type	Output
SEND A	▶1 DISTORTION	▶L-R
SEND B	▶2 STEREO LINKED	▶L-R
SEND C	▶3 DELAY>STEREO	▶L-R
SEND D	▶4 STEREO LINKED	▶L-R
PATCH EDIT MIX		

Stereo Samples in Programs and Multis can be routed to linked FX via the AB or CD FX Send. See “Configuring Keygroup Programs” on page 51 and “Applying FX to Parts” on page 72 for more information.

In the following linked example, FX1 and FX2 are linked together to provide stereo distortion.

SEND A	▶1 DISTORTION	▶L-R
SEND B	▶2 STEREO LINKED	▶

In the following linked example, FX1 and FX2, and FX3 and FX4 are linked to provide stereo distortion in series with stereo compression. The output of FX1 is set to “OFF.” The input source for FX3 and FX4 are set to FX1 and FX2, respectively.

Input	FX Type	Output
SEND A	▶1 DISTORTION	▶OFF
SEND B	▶2 STEREO LINKED	▶
FX 1	▶3 COMPRESSOR/LIMITER	▶L-R
FX 2	▶4 STEREO LINKED	▶

4 To unlink a pair of FX, select the “Input” or “Output” parameter of the pair, and press the WINDOW button.

The Stereo Link OFF window appears.

5 Press “DO IT” to unlink the selected FX.

Setting the FX Level

You can set each FX level and turn the direct signal on or off, as follows.

1 Press the FX button, then press “MIX.”

The MIX page appears.

FX Type	Output	Level	Direct
1 DISTORTION	▶L-R	0	OFF
2 STEREO LINKED	▶L-R	0	OFF
3 DELAY>STEREO	▶L-R	0	OFF
4 STEREO LINKED	▶L-R	0	OFF

PATCH EDIT MIX

The “Fx Type” column and the “Output” column are the same as those on the PATCH page.

Level: Adjusts the output level of each effect.

Direct: When the parameter is set to OFF, the direct signal of the Program or Part routed to the corresponding FX is not output. For example, if you wish to use only the effect sound without any direct sound, (such as the distortion or compressor), set this parameter to OFF to output only the processed signal. When the parameter is set to ON, both the effect signal and the direct Program or Part signal are output.

Editing FX

FX can be edited as follows.

1 Press the FX button.

The FX button indicator lights up and the PATCH page appears.

Input	FX Type	Output
SEND A	▶1 DISTORTION	▶OFF
FX 1	▶2 REVERB>STUDIO	▶L-R
SEND B	▶3 DELAY>STEREO	▶L-R
SEND B	▶4 REVERB>BIG ROOM	▶1-2

PATCH EDIT MIX

2 In the “FX Type” column, select the FX processor that you want to edit.

3 Press “EDIT.”

The edit page for the selected FX appears, as shown in the example below.

FX1 Type: DISTORTION		Wet/Dry
Depth	: 20	: 100
EQ freq	: 0	Effect
EQ gain	: +0dB EQ Q : 0.5	: ON

PATCH EDIT

4 Select the parameters and use the JOG dial to set them as required.

FX can be turned on and off by using the “Effect: ON/OFF” parameter, or by pressing “ON/OFF.”

The “Wet|Dry” parameter specifies the balance between the effect sound and the direct sound. When it is set to “100,” only the effect sound is output. When it is set to “0,” only the direct sound is output.

Note: Even when the “Wet/Dry” parameter is set to “100,” direct sound is output if the “Direct” parameter is set to ON on the MIX page. To make sure that only the effect sound is output, set the “Wet/Dry” parameter to “100,” and set the “Direct” parameter to “OFF.”

FX Types

See page 79 for selecting FX types, and page 81 for editing FX.

FX Type	Description
Chorus>Mono	This is a standard chorus effect with mono-in and mono-out. You can adjust the pan setting of the effect sound.
Chorus>Stereo	This is a stereo chorus effect that adds width and spread to the stereo image.
Chorus>Xover	This is a variation of the STEREO CHORUS. The feedback from each channel is fed to the other channel.
Chorus+Delay	This effect consists of a chorus effect and a delay effect connected in series.
Compressor/Limiter	This monaural effect suppresses signals with a certain level or higher and limits the dynamic range. It also provides a noise gate that cuts noise during silence.
Delay>Mono	This is a standard delay effect with mono-in and mono-out. You can adjust the pan setting of the effect sound.
Delay>Multi Tap	This delay effect creates a special effect by adjusting the interval between feedback sounds and the level change curve of the feedback sounds.
Delay>Panning	This delay effect pans the delay sound left, center, then right (LCR), or right, center, then left (RCL).
Delay>Ping Pong	This delay effect pans the effect sound left and right.
Delay>Stereo	This delay effect can be set for the left and right channels individually.
Delay>Xover	This is a variation of the STEREO DELAY. The feedback from each channel is fed to the other channel.
Digital EQ	This is a monaural, three-band parametric equalizer.
Distortion	This monaural distortion effect distorts input signals. An equalizer is connected to the effect in series.
Enhancer	This monaural effect enhances sounds by adding new overtones.
Expander	This monaural effect limits signals at a certain level (threshold) or lower and expands the dynamic range, providing an effect opposite to the compressor effect.
Flanger>Mono	This is a standard flanger effect with mono-in and mono-out. You can adjust the pan setting of the effect sound.
Flanger>Pan	This effect adds an auto panning effect to the mono flanger.
Flanger>Stereo	This is a stereo flanger effect that adds width and spread.
Flanger>Xover	This is a variation of the STEREO FLANGER. The feedback from each channel is fed to the other channel.
Flanger+Delay	This monaural effect consists of a flanger effect and a delay effect connected in series.
Noise Gate	This monaural effect mutes signals at a certain level (threshold) or lower. This is useful for cutting noise during silent parts of a performance.
Pan>Auto Pan	This auto pan effect automatically rotates the stereo image of the sound left and right. It also adds depth of rotation.
Pan>Trigger Pan	This auto pan effect becomes enabled when the output level of one of the AUX Sends A-D exceeds a certain level. You can also start the auto pan effect manually.
Phaser>Mono	This is a standard phaser effect with mono-in and mono-out. You can adjust the pan setting of the effect sound.
Phaser>Pan	This effect adds an auto panning effect to the phaser effect sound.
Phaser>Stereo	This is a phaser effect that adds width and spread to the stereo image.
Phaser>Xover	This is a variation of the STEREO PHASER. The feedback from each channel is fed to the other channel.

FX Type	Description
Phaser+Delay	This monaural effect consists of a phaser effect and a delay effect connected in series.
Pitch Corrector	This monaural effect corrects the pitch of input signals in real time. This is useful when you want to correct the pitch of, say, a vocal track.
Pitch Shifter	This effect has a pitch shift with a range of ± 1 octave, and can be set for the left and the right channels independently.
Reverb>Auditorium	This stereo reverb effect simulates reverberations of an auditorium.
Reverb>Big Hall	This stereo reverb effect simulates reverberations of a big hall.
Reverb>Big Room	This stereo reverb effect simulates reverberations of a big room.
Reverb>Bright Hall	This stereo reverb effect simulates bright reverberations of a hall.
Reverb>Bright Plate	This stereo reverb effect simulates reverberations of a plate reverb with expressive character.
Reverb>Drum Booth	This stereo reverb effect simulates reverberations of a drum booth.
Reverb>Live house	This stereo reverb effect simulates reverberations of a live house.
Reverb>Medium Hall	This stereo reverb effect simulates reverberations of a medium-size hall.
Reverb>Medium Room	This stereo reverb effect simulates reverberations of a medium-size room.
Reverb>Non-linear	This reverb effect simulates reverberations that are cut by a gate.
Reverb>Plate 1	This stereo reverb effect simulates reverberations of a typical plate reverb.
Reverb>Reverse	This stereo reverb effect simulates reverberations with reverse playback.
Reverb>Small Hall	This stereo reverb effect simulates reverberations of a small hall.
Reverb>Small Room	This stereo reverb effect simulates reverberations of a small room.
Reverb>Studio	This stereo reverb effect simulates reverberations of a recording studio.
Reverb>Theater	This stereo reverb effect simulates reverberations of a theater.
Reverb>Vocal Plate	This stereo reverb effect simulates reverberations of a plate reverb suitable for vocals.
Reverb>Warehouse	This stereo reverb effect simulates reverberations of a warehouse.
Rotary Speaker	This stereo-out effect simulates rotary speakers for organ sound. Use MIDI Control Change messages (input from a MIDI IN port or the (F4) (R1)><(R2) button) to toggle between two rotation speeds (Rate1 / Rate2).
Tape Echo	This delay effect simulates a 3-head tape echo machine. You can set three delay times individually. This effect has mono-in and mono-out; however, you can adjust the pan setting of the effect sound.
WAH>AUTO WAH	This monaural effect adds a swelling wah.
WAH>TOUCH WAH	This monaural effect adds a wah effect to signals at a certain level or higher.

11 Saving

Saving

Samples, Programs, Multis, and Songs can be saved to any of the available storage devices as follows.

1 Press the SAVE button.

Its indicator lights up, and the following SAVE page appears.



This page displays the amount of free space available on the currently selected disk (“Free=”), and the size of the currently selected file (“Size=”).

- 2 On the “Disk” parameter, use the JOG dial to open the Disk List window.**
- 3 Use the CURSOR buttons to select a disk, and press “CLOSE” to close the window.**

The disk is selected.



This window displays information about the connected storage devices, including media type, disk name, device connection method (SCSI ID), and the amount of free space. Disk partitions are displayed as separate disks. Disks can be selected by using the JOG dial or CURSOR Up and Down buttons. You can display more information about the selected disk by pressing “INFO.” Disks can be renamed by pressing “RENAME.” The “UPDATE” button updates the Disk List.

***Note:** If a removable storage device is connected, when you want to change the disk, press “EJECT” on the SAVE page, not the eject button on the device. While the device is connected to the Z8, its eject button is disabled.*

4 Select the Folder (█) parameter, and use the JOG dial to select a folder.

To move transversely through the folder hierarchy, while holding down the SHIFT button, use the Left and Right CURSOR buttons. Alternatively, use the Folder window, shown below, which can be opened by pressing the WINDOW button while the Folder parameter is selected.

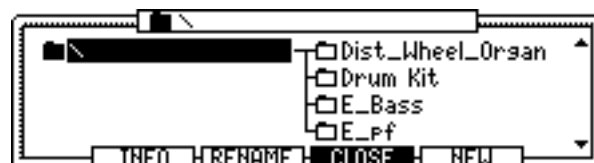

Use the JOG dial or the CURSOR Up and Down buttons to move up and down the tree, and use the CURSOR Left and Right buttons to move through the tree transversely. The selected folder appears highlighted and its name appears in the window's title bar. The file is stored in the folder selected on the left of the file (which is in the upper hierarchy of the tree). When you've selected a folder, press "CLOSE."

You can display information about the selected folder by pressing "INFORM." Folders and files can be renamed by pressing "RENAME." New folders can be created by pressing "NEW."

5 Select the "Type" parameter, and use the JOG dial to select one of the following options:

SAVE SAMPLE (saves Samples), SAVE PROGRAM (saves Programs), SAVE MULTI (saves Multi), SAVE SONGS (saves Songs), SAVE ALL (saves all files in memory).

The Item parameter indicates only the file selected in the "Type" parameter. If "SAVE ALL" is selected, the Item parameter does not appear.

6 Select the "Item" parameter, and use the JOG dial to select the file in memory that you want to save.

7 Press "DO IT" to save the specified file, press "ALL" to save all files of the specified type in memory, or press "MODIFY" to save only new and modified files.

If you have selected a Sample, you can save it by pressing "DO IT."

When you press "ALL," a window similar to the following appears.

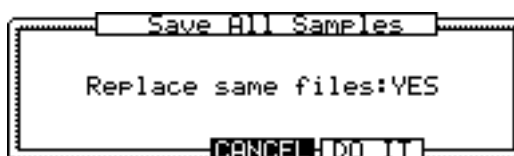

When the "Replace same samples" parameter is set to "YES," the Sample in memory replaces the file on the disk. If the parameter is set to "NO," Samples with the identical names are not saved.

Press "DO IT" to save all Samples.

When you press "MODIFIED," a window similar to the following appears.

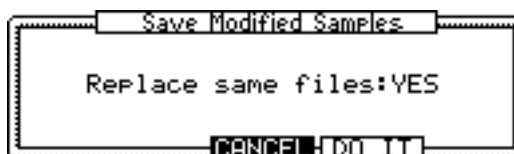

Only new or modified files (which display an asterisk) are saved. The save operation is the same as when you press "ALL."

If you are saving a Program, a window similar to the following appears.

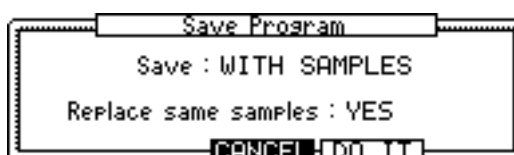

8 Set the “Save” and “Replace same samples” parameters as required, and then press “DO IT.”

The “Save” parameter options are as follows: “WITH SAMPLES” saves the Program with all its Samples. “PROGRAM ONLY” saves the Program and no Samples. “NEW & MODIFIED” saves the Program and only the new and modified Samples.

The “Replace same samples” parameter options are as follows: “YES” replaces Samples with the same names. “NO” does not save Samples with the same names.

When you press “ALL,” the Save ALL Program window appears. When you press “MODIFIED,” the Save Modified Program window appears. Operations in these windows are the same as in the Save Program window.

If you’re saving a Multi, a window similar to the following appears.

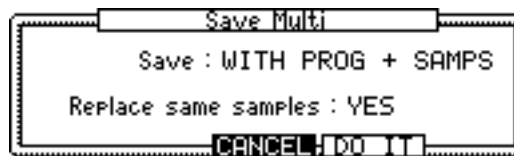

9 Set the “Save” and “Replace same samples” parameters as required, and then press “DO IT.”

The “Save” parameter options are as follows: “MULTI ONLY” saves the Multi with no Programs and no Samples. “WITH PROGS+SAMPLES” saves the Multi with its Programs and Samples. “WITH PROGRAMS” saves the Multi with its Programs. “NEW & MODIFIED” saves the Multi with all its new and modified Programs and Samples.

The “Replace same samples” parameter options are the same as for Programs (see above).

If you select “SAVE ALL,” a window similar to the following appears.

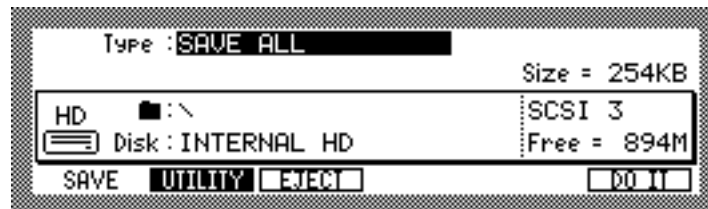

Press “DO IT” to open the Save ALL Items window. The “Replace same Samples” parameter options are as follows: “YES” replaces files with the same names. “NO” does not save files with the same names.

Press “DO IT” to start saving files.

If you are saving a Song, select “SAVE SONG” for the “Type” parameter, select the file you wish to save for the Item parameter, then press “DO IT.”

12 Disk & File Utilities

The disk and file utilities allow you to delete files and folders, and format disk drives.

Deleting Files & Folders

Files and folders can be deleted as follows.

1 In Save or Load mode, press “UTILITY.”

The following page appears.

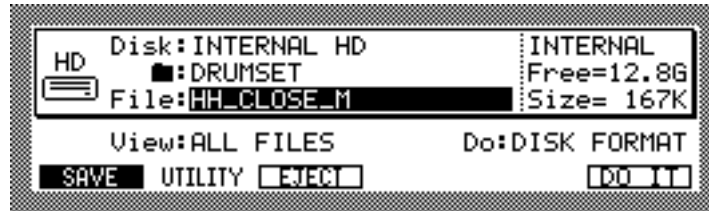

2 Select the “View” parameter, and then use the JOG dial to select “ALL FILES.”

The View parameter allows you to filter the file types that can be selected by the File parameter, which is useful when you have many files and folders. For example, if you set the View parameter to “SAMPLES,” only Sample files and folders appear at the File parameter. Other options include: PROGRAMS, MULTIS, and FOLDERS.

3 Select the “Disk” parameter, and use the JOG dial to select the disk that contains the file or folder.

Disks can be selected from the Disk List window. See “Saving” on page 84 for more information.

4 Select the Folder (■) parameter, and use the JOG dial to select the folder containing the file or folder to be copied, moved, or deleted.

To move transversely through the folder hierarchy, while holding down the SHIFT button, use the Left and Right CURSOR buttons. Alternatively, use the Folder window, which can be opened by pressing the WINDOW button while the Folder parameter is selected. See “Saving” on page 84 for more information.

5 Select the “File” parameter, and use the JOG dial to select a file or folder.

6 Select the “Do” parameter, and use the JOG dial to select DELETE.

7 Press “DO IT.”

The file or folder is deleted.

Formatting Disks

Disks can be formatted as follows.

Note: Formatting a disk erases all data stored on it. Copy any important data to another storage device before proceeding.

1 In Save or Load mode, press “UTILITY.”

The following page appears.

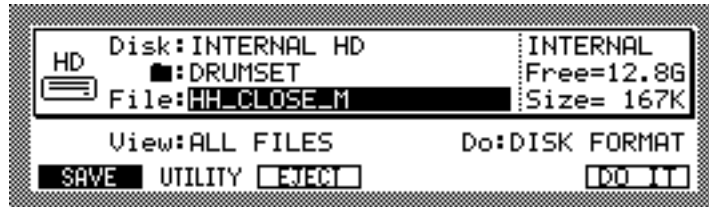

2 Select the “Disk” parameter, and use the JOG dial to select a disk.

Disks can be selected from the Disk List window. See “Loading” on page 18 for more information.

3 Select the “Do” parameter, and use the JOG dial to select “DISK FORMAT.”

4 Press “DO IT.”

The Format Disk window appears, as shown below.

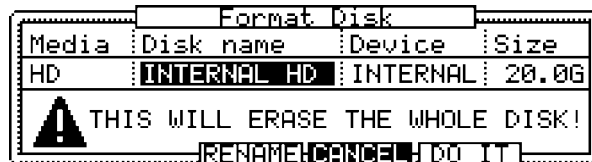

5 Press “DO IT” to format the disk, or press “RENAME” to rename it first.

If you press “RENAME,” the Name window opens. See “Entering Names” on page 17 for information on naming.

6 When the warning window appears, press “DO IT.”

Formatting commences. The time taken to format a disk depends on its size.

The Z8 supports FAT16 and FAT32 DOS disk formats. Disks smaller than 2 GB are formatted as FAT16. Larger disks are formatted as FAT32.

You can also use the Quick Format and Wipe Volume functions by selecting “QUICK FORMAT” and “WIPE VOLUME” for the “Do” parameter respectively. The Quick Format function initializes only the file data on the disk, and takes less time compared to the Disk Format operation. The Wipe Volume function initializes the disk by volumes (partitions).

13 General Utilities

This chapter explains the functions available in Utilities mode.

Setting the Master Level, Tuning, SCSI ID & MIDI OUT/THRU

The master level, master tuning, and the Z8's SCSI ID can be set as follows.

1 Press the UTILITIES button.

The UTILITIES button indicator lights up and the GLOBAL page appears.

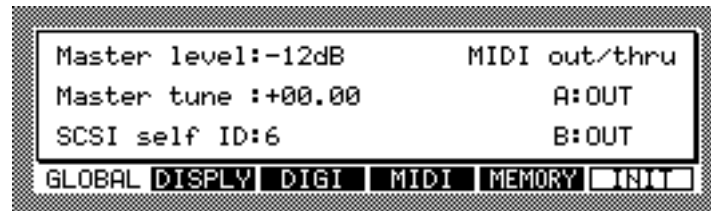

2 Select the parameters, and use the JOG dial to set them as required.

Master level: Sets the overall output level. The default value is “-12 dB,” the reason for this is to prevent output distortion when many “hot” Samples (i.e., Samples at levels close to 0 dB) are played simultaneously.

Master tune: Sets the overall pitch in semitone and cent steps.

SCSI self ID: Sets the SCSI ID of the Z8, the default being “6.”

Note: Never assign the same SCSI ID to two or more SCSI devices.

MIDI out/thru A & B: These set the function of the MIDI OUT/THRU ports to either MIDI OUT or MIDI THRU.

Setting the Display Contrast, Note Display, Date & Time

The display contrast, note display format, date, and time can be set as follows. The Z8 uses the Date and Time settings to date stamp files when they are saved.

1 Press the UTILITIES button, and then select the DISPLY page shown below.

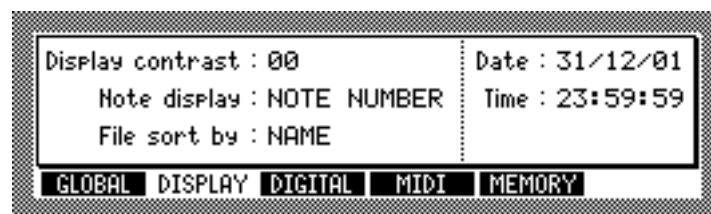

2 Select the parameters, and use the JOG dial to set them as required.

Display contrast: Sets the contrast of the display.

Note display: (NOTE NUMBER or NOTE NAME) This determines how note values are displayed on the display pages. When set to NOTE NUMBER, note values are displayed as MIDI note numbers (e.g., 0 to 127). When set to NOTE NAME, they are displayed as names (e.g., C-2 to G8).

Date: Sets the date in day, month, and year format.

Time: Sets the time in hour, minute, and second format.

Setting the System Clock & Digital Out Sync

The system clock and DIGITAL OUT sync source can be set as follows.

- 1 Press the UTILITIES button, then select the DIGI page shown below.



- 2 Select the parameters, and use the JOG dial to set them as required.

System clock

This parameter determines the sampling rate and source of the Z8's system clock.

44.1 kHz: Sets the system clock to 44.1 kHz.

48 kHz: Sets the system clock to 48 kHz.

96 kHz: Sets the system clock to 96 kHz. The polyphony is reduced by half.

When the JOG dial is rotated, a window appears for you to select the system clock. Select the system clock, and then press "DO IT."

Warning: When the system clock is changed, the Z8 is reset and the memory contents cleared. Be sure to save any important data before changing the system clock.

DIGITAL OUT sync

This parameter allows you to set the sync source for the DIGITAL OUT independently of the Z8's system clock. This is convenient when the Z8's system clock is running at, for example, 96 kHz, and you need to integrate the Z8 into a system that is running at 44.1 kHz. By connecting an external 44.1 kHz clock to the WORDCLOCK IN, and setting the DIGITAL OUT sync source to the WORDCLOCK IN, you can output digital audio at 44.1 kHz via the DIGITAL OUT regardless of the fact that the Z8's internal clock is running at 96 kHz.

INTERNAL: Synchronizes the DIGITAL OUT signal to the Z8's system clock.

DIGITAL IN: Synchronizes the DIGITAL OUT signal to the digital audio signal being received by the DIGITAL IN.

ADAT IN: Synchronizes the DIGITAL OUT signal to the digital audio signal being received by the ADAT IN.

WORDCLOCK: Synchronizes the DIGITAL OUT signal to the clock signal being received by the WORDCLOCK IN.

Type

This parameter enables you to select the data format of the digital output.

CONSUMER: This format is commonly used for CD players, DAT players, and other consumer products.

PROFESSIONAL: This format is primarily used on the industry's professional equipment.

ADAT out 1/2

This parameter appears only when an optional ADAT board is installed. Select the signals output from ADAT out 1/2. When you select "1/2," the signals output from Individual out 1/2 are also output from ADAT out 1/2. When you select "L-R," the signals output from MAIN OUT (L/R) are also output from ADAT out 1/2.

Monitoring MIDI Activity

You can monitor MIDI activity at the MIDI IN A and B ports as follows.

- 1 Press the UTILITIES button, then select the MIDI page shown below.

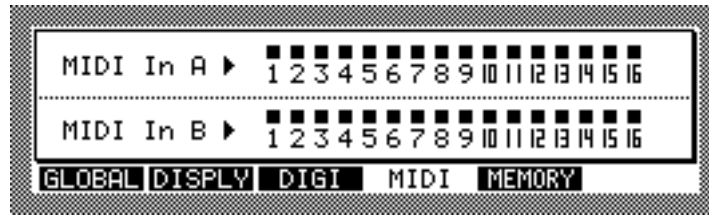

When a MIDI message is received, a square indicator appears above the corresponding port and MIDI Channel number, useful for troubleshooting MIDI setups.

Initializing the Z8

All parameters inside the Z8 can be reset to their factory defaults as follows.

- 1 Press the UTILITIES button.

The UTILITIES button indicator lights up and the GLOBAL page appears.

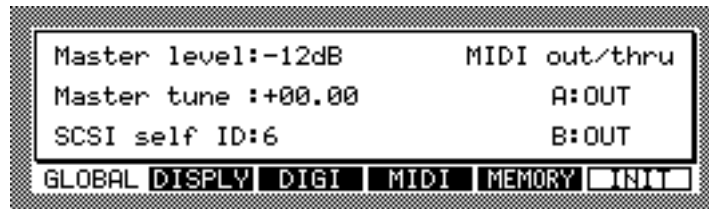

- 2 Press "INIT."

The Initialize ALL PARAMETERS window appears, as shown below.

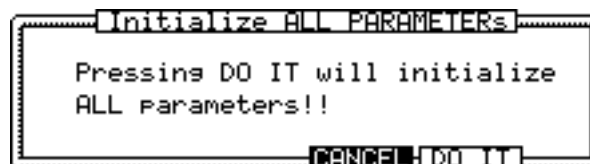

- 3 Press "DO IT."

All parameters are reset to their factory defaults.

Erasing Entire Memory

You can erase the Z8 memory as follows.

- 1 Press the **UTILITIES** button, then select the **MEMORY** page, shown below.

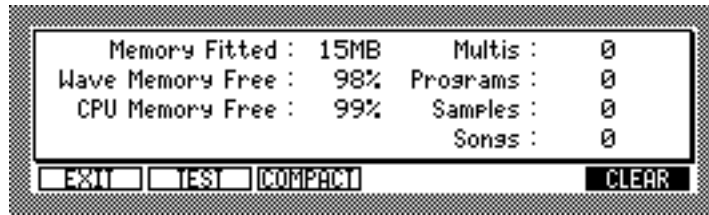

The **MEMORY** page includes the following information.

Memory Fitted: Indicates the installed memory size.

Wave Memory Free: Indicates the available Wave memory size.

CPU Memory Free: Indicates the available CPU memory size. The number of files that can be stored in the Z8 is determined by the CPU memory size.

Multis, Programs, Samples, Songs: Indicate the number of Multis, Programs, Samples, and Songs in memory.

- 1 Press **“CLEAR”** to open the **CLEAR MEMORY** window, shown below.

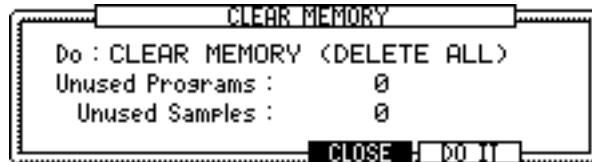

- 2 Select the **“Do”** parameter, then use the **JOG** dial to select **“CLEAR MEMORY (DELETE ALL)”**.
- 3 Press **“DO IT.”**

The Warning window appears for confirmation.

- 4 Press **“YES”** to erase all data in memory.

You can also select **“PURGE UNUSED SAMPLES,”** or **“PURGE UNUSED PROGRAMS”** for the **“Do”** parameter. These functions are the same as **“PURGE SAMPLES”** and **“PURGE PROGRAMS”** in the Program window in Program mode. After selecting one of these functions, press **“DO IT”** to open the Warning window, then press **“YES”** to execute the function.

Testing Memory

You can test the memory inside the Z8 by pressing **“TEST”** on the **MEMORY** page.

When you press **“TEST,”** the Z8 automatically starts the memory test. When the test is complete, the result is displayed.

Defragmenting the Memory Space

When you load, record, or delete Samples frequently, unnecessary space is created between data in memory. You can re-arrange the data to free up memory space by pressing **“COMPACT”** on the **MEMORY** page.

When the process is complete, press **“EXIT”** to return to the **GLOBAL** page.

Appendix

Specifications

Model Name	Sampler Z8/Z4	
Sampling data format	24/16-bit linear encoding	
Sampling rates	44.1 kHz (20 Hz–20 kHz audio bandwidth)	
	48 kHz (20 Hz–22 kHz audio bandwidth)	
	96 kHz (20 Hz–40 kHz audio bandwidth)	
Sampling time (standard memory)	180/120 seconds (16/24 bit) - mono Fs = 44.1 kHz	
	166/110 seconds (16/24 bit) - mono Fs = 48 kHz	
	83/55 seconds (16/24 bit) - mono Fs = 96 kHz	
	90/60 seconds (16/24 bit) - stereo Fs = 44.1 kHz	
	83/55 seconds (16/24 bit) - stereo Fs = 48 kHz	
Internal memory	16 MB, expandable to 512 MB using 168-pin DIMMs (PC133/PC100, CL2, 256 MB max.)	
	64 voices	
Filter	Digital dynamic multistage filter (2-pole x 3 with resonance)	
Envelope generators	3 x Digital Envelope generators (2 multistage)	
LFO	2 x Multi-Wave Low Frequency Oscillators	
Display	Backlit 248 x 60 dot graphic LCD	
Connectors	REC IN	2 x 1/4" stereo phone (balanced)
	STEREO OUT	2 x 1/4" stereo phone (balanced) 6 dBm
	ASSIGNABLE OUTS	8 x 1/4" stereo phone (balanced) 6 dBm (optional)
	HEADPHONES	1 x 1/4" stereo phone 60 mW (32 ohms load) max.
	MIDI	4 x 5-pin DIN (IN, OUT/THRU x 2)
	SCSI Interface	1 x 50-pin high pitch SCSI
	S/PDIF digital IN/OUT	2 x phono input/output (optional on Z4)
	Word clock input	BNC (75 ohms w/terminator ON/OFF, optional on Z4)
USB	Host x 1, Slave x 1 (V1.1)	
Power requirements	100–240 V AC 50/60 Hz 60 W, without options 24 W - Z8/19 W - Z4	
Dimensions (W x H x D)	Z8 - 483 x 91 x 415 mm (EIA 2U size) Z4 - 483 x 91 x 402 mm (EIA 2U size)	
Weight	Z8 - 6.4 kg, Z4 - 6.1 kg	
Supplied accessories	AC power cable x 1	
	Sound Library Disc x 1	
	Cable set for IDE drive x 1	
	Contact Cover x1	
	User Guide	
Optional accessories	EB4JS	Multi Effects Board (Z4 only)
	IB-4D	S/PDIF Digital Interface Board (Z4 only)
	IB-4ADT	2-IN/8-OUT adat™ Interface Board ¹
	IB-48P	8 Individual Outputs Board ¹

1. IB-4ADT and IB-48P cannot be installed at the same time.

Specifications are subject to change without prior notice.

Index

Numerics

3.5" drive bay 8, 9

A

AC inlet 10
 Adjust 36
 Amp envelopes 65
 Assign 25
 Auditioning Samples while editing
 31
 Auto Loop 42
 Auto normalize 22
 Auto sampling 26
 Aux envelopes 65

B

Bit-rate 22
 BPM Tempo Matching 45

C

Clipboard 16
 CLIPBOARD button 7, 16
 Contrast, display 89
 Converting Programs 60
 Copying
 Multis 72
 Programs 60
 Samples 46
 Creating
 Drum Programs 56
 Keygroup Programs 50
 Keygroups 51
 Multis 68
 Parts 69
 Crossfading
 drum Zones 57
 Keygroup Zones 51
 Keygroups 51
 loops 42
 CURSOR buttons 7
 custom scale 61

D

Date, setting 89
 Defaults
 initializing 91
 loading 18
 saving 84
 Defragmenting 92
 DELETE SECTION 35

Deleting

Files, Folders 87
 Multis 73
 Programs 60
 Samples 47
 DIGITAL I/O 9
 Digital out sync setting 90
 DISCARD 34
 Display 7
 Display contrast 89
 Drum Programs
 about 3
 applying FX 57
 configuring 57
 converting to keygroup pro-
 grams 60
 creating 56
 Fx 57
 mute groups 58
 pan 57
 selecting 48
 tuning drums 57
 Zones 58

E

Edit Functions 34
 Editing
 DELETE SECTION 35
 DISCARD 34
 EXTRACT 34
 FADE UP/DOWN 36
 FX 81
 INSERT SAMPLE TO START
 35
 JOIN A->B 36
 MERGE 36
 MONO TO STEREO 38
 Multis 67
 NORMALIZE 37
 parameters 14
 PITCH SHIFT 35
 Programs 48
 RE-SAMPLE 34
 RE-SCALE 37
 REVERSE 35
 Samples 29, 33
 SILENCE 35
 STEREO TO MONO 38
 TIME STRETCH 38
 End point
 display format 32
 Samples 30
 Entering names 17
 Envelopes in Programs 65
 Erasing 92
 EXTRACT 34

F

FADE UP/DOWN 36
 Features 1
 Filter envelopes 65
 Filtering MIDI messages 71
 Filters in Programs 64
 Formatting disks 88
 Free 18
 Function buttons F1 to F6 8
 FX
 about 5
 applying to Drum Programs 57
 applying to Keygroup Programs
 51
 applying to Parts 72
 button & indicator 7
 editing 81
 FX type list 82
 inputs 78
 Level 81
 linking 80
 mode 39
 outputs 79
 Q-Link 75
 resampling with FX 38
 sampling with FX 27
 selecting FX types 79

H

Hookup example 11

I

Initializing the Z8 91
 INSERT SAMPLE TO START 35
 Installation 11

J

JOG dial 7
 JOIN A->B 36

K

KEEP or RETRY window 33
 Keyboards
 USB 17
 user scales 61
 Keygroup Programs
 about 2
 configuring 51
 converting to Drum Programs 60
 creating 50
 Keyspan 53
 selecting 48
 tuning 53
 Zones 51

- Keygroups
 - creating and configuring 51
 - crossfading 51
 - tuning 51
- Keyspan
 - Keygroups 51
 - Parts 69
- L**
- Legato, Programs 49
- LFOs in Programs 63
- Linking FX 80
- LOAD button & indicator 8
- Loading
 - about 5
 - files 18
 - Folders 21
 - Multis 20
 - Programs 20
 - Samples 20
- Loop Points 41
- Looping
 - crossfading 42
 - setting 40
- M**
- MAIN OUT 10
- MAIN VOLUME control 7
- Margin 22, 23
- Master level setting 89
- Master tuning setting 89
- Memory, free 18, 22
- MERGE 36
- Merging Programs 60
- MIDI
 - activity indicators 7
 - activity monitor 91
 - assigning Channels to Parts 69
 - assigning Program Changes to Multis 68
 - assigning Program Changes to Programs 49
 - filtering messages 71
 - OUT/THRU port settings 89
 - ports 10
 - Program options 61
 - soft pedal 61
- Modulating
 - drum Zones 57
 - Keygroup Zones 51
 - Programs 58
- Monitor 23
- Monitoring
 - MIDI activity 91
 - Monitor 49
 - Programs while editing 49
 - Samples while editing 29
 - while sampling 22
- Mono Sample 23
- MONO TO STEREO 38
- Mono/stereo Samples
 - recording 22
 - viewing waveforms 29
- MULTI button & indicator 7
- Multis
 - about 5
 - applying FX 72
 - assigning Program Changes 68
 - assigning Programs 69
 - copying 72
 - creating 68
 - deleting 73
 - editing 67
 - filtering MIDI messages 71
 - loading 18
 - renaming 68
 - saving 84
 - selecting 67
- Mute groups
 - Drum Programs 57
 - Keygroup Programs 51, 54
- N**
- Naming 17
- NORMALIZE 37
- O**
- Option slot 9
- Original 23
- P**
- Pages, about 14
- Panning
 - drum Zones 57
 - Parts 69
 - Zones 51, 54
- Parts
 - applying FX 72
 - assigning MIDI Channels 69
 - assigning Programs 69
 - creating 69
 - deleting 69
 - filtering MIDI messages 71
 - keyspan 69
 - panning 69
 - Q-Link 75
 - sort 69
 - tuning 69
- PHONES jack 8
- Pitch bend setup, Programs 62
- PITCH SHIFT 35
- PLAY button 7, 15
- Portamento, Programs 49
- Power cord, connecting 13
- POWER switch 6
- Powering up the Z8 13
- Pre-recording 22
- Preset 35
- PROGRAM button & indicator 7
- Programs
 - about 2
 - adding Samples while recording 25
 - amp, filter, and aux envelopes 65
 - applying FX to Drum Programs 57
 - applying FX to Keygroup Programs 51
 - assigning MIDI Program Changes 49
 - assigning to Parts 69
 - configuring 49
 - copying 60
 - creating Drum Programs 56
 - creating Keygroup Programs 50
 - deleting 60
 - filters 64
 - legato 49
 - LFOs 63
 - loading 18
 - merging 60
 - MIDI options 61
 - modulation 58
 - Mono legato 50
 - No. 49
 - pitch bend setup 62
 - portamento 50
 - renaming 60
 - saving 84
 - selecting 48
 - transposing 49
 - tuning 49
 - Zones 51
- Projects
 - loading 18
 - saving 84
- Purging
 - Programs 60
 - Samples 60
- Q**
- Q-FX
 - COMMAND 39
 - resampling 38
 - sampling with 27
- Q-Link
 - about 75
 - configuring and using 75
 - controls 6
- Q-LINK SETUP button 7

R

- REC GAIN control 8
- REC IN 10
- RECORD button & indicator 7
- Recording samples 22
- Regions
 - adjusting Start & End points 43
 - setting 43
 - slicing 44
- Removable Panel release button 8
- Removable panel, detaching 13
- Renaming
 - Multis 68
 - Programs 60
 - Samples 46
- RE-SAMPLE 34
- Resampling with FX 38
- RE-SCALE 37
- Resolution, setting 22
- REVERSE 35

S

- SAMPLE button & indicator 6
- Samples
 - about 2
 - adding to Programs in Sample Edit mode 47
 - adding to Programs while recording 25
 - auditioning while editing 31
 - copying 46
 - deleting 47
 - editing 29, 33
 - End point display format 32
 - loading 18
 - looping, see Looping
 - original note 46
 - recording 22
 - renaming 46
 - saving 84
 - size 46
 - Start Point 32
 - tuning 46
 - zooming 31
- Sampling
 - auto sampling 26
 - bit depth 22
 - normal sampling 22
 - resampling with FX 38
 - sampling with FX 27
- SAVE button & indicator 8
- Saving
 - about 5
 - files 84

SCSI

- connecting devices 12
- formatting disks 88
- port 10
- Z8 ID 89
- Selecting
 - FX types 79
 - Multis 67
 - parameters 14
 - Programs 48
 - Samples for editing 29
- SHIFT button 8
- SILENCE 35
- Size 18
- SMF, playing 74
- Songs, playing 74
- Start Point 30, 32
- Stereo Sample 23
- STEREO TO MONO 38
- Switching on the Z8 13
- Sync 90
- System clock, setting 90
- System sampling rate 22

T

- Tag 30
- TERMINATOR switch 9
- Testing Memory 92
- Threshold, sampling 22
- Time 23
- TIME STRETCH 38
- Time, setting 89
- Transposing Programs 49
- Trim 30
- Tune 36
- Tuning
 - drum Zones 57
 - drums 57
 - Keygroups 51
 - master setting 89
 - Parts 69
 - Programs 49
 - Samples 46
 - Zones 51, 55
- Turning on the Z8 13

U

- USB
 - connecting devices 12
 - formatting disks 88
 - keyboard 17
 - port 10
- UTILITIES button & indicator 8

W

- Wave 18
- Waveform 31
- WINDOW button 8
- Windows, about 14
- WORDCLOCK IN 9
- Wordclock, see system clock

Z

- Zones
 - crossfading drum Zones 57
 - in Drums Programs 57
 - in Keygroup Programs 51
 - modulating drum Zones 57
 - modulating Keygroup Zones 51
 - panning drum Zones 57
 - panning Keygroup Zones 51
 - tuning drum Zones 57
 - tuning Keygroup Zones 51
- Zooming Samples 31

Z4/Z8 MIDI IMPLEMENTATION CHART

Version : V1.0

Date : Feb, 2002

FUNCTION...	TRANSMITTED	RECOGNISED	REMARKS
BASIC CHANNEL Default: X Changed: X	X X	1-16 1-16	Memorized (disk)
MODE Default: X Messages: X Altered: *****	X X *****	MODE 3 MODE 1, 3	Multi Mode Program/Sample Mode
NOTE NUMBER True Voice: X *****	X *****	0-127 0-127	C-2 - G8 C-2 - G8
VELOCITY Note ON: X Note OFF: X	X X	O X	
AFTERTOUCH Key's: X Channel: X	X X	O O	Selectable as KEY or CHANNEL
PITCH BEND	X	O	+/- 24 Semitones
CONTROL CHANGE	0 X 1 X 7 X 10 X 64 X 65 X 67 X 68 X 84 X 0-127 X	O O O O O O O O O O	Bank Select (Multi) Modulation Wheel Volume Pan Sustain Pedal Portamento ON/OFF Soft Pedal Legato Portamento Control Via Program Modulation
PROGRAM CHANGE True #: X *****	X *****	O (0-127)	Shown as 1-128. By preset number value
SYSTEM EXCLUSIVE	O	O	AKAI ID : 47H Z4/Z8 ID : 5FH
SYSTEM COMMON Song Pos: X Song Sel: X Tune: X	X X X	O O X	
SYSTEM REAL TIME Clock: X Commands: X	X X	O O	To LFO1/LFO2 Start, Stop, Continue
AUX MESSAGES All Sound Off: X Reset Controllers: X Local ON/OFF: X All Notes OFF: X Active Sensing: X System Reset: X	X X X X X X	O O X O X X	

Mode 1 : OMNI ON, POLY
Mode 3 : OMNI OFF, POLY

Mode 2 : OMNI ON, MONO
Mode 4 : OMNI OFF, MONO

O : YES
X : NO



AKAI professional M.I. Corp.