

micro

Q



User's Manual

microQ Omega/lite/Keyboard



 waldorf

Product information microQ series

Upgrades

The following upgrades are available:



i The **microQ lite** can be upgraded to a fullrange **microQ**. Therefore you need a special upgrade software (standard MIDI file format) which can be installed by the customer itself. For more information about price and handling please contact our product support (see page 6).

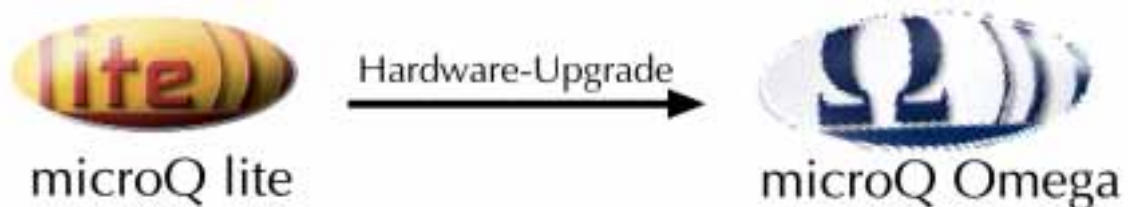

i The **microQ lite** can be upgraded to a **microQ Omega** (with up to 75 voices). Therefore you need a hardware modification that is done exclusively by official Waldorf Distributors or official Waldorf Service Centers. More information about price and handling can be found on our website <http://www.waldorf-music.com> or by contacting our product support (see page 6).



i The **microQ/microQ Keyboard** can be upgraded to a **microQ Omega** (with up to 75 voices). Therefore you need a hardware modification that is done exclusively by official Waldorf Distributors or official Waldorf Service Centers. More information about price and handling can be found on our website <http://www.waldorf-music.com> or by contacting our product support (see page 6).

Waldorf Merchandise



Dance & Techno Construction Soundset for microQ and Q
300 Sounds, 2 Drum Maps and 30 Multis for your electronic music production
CD-ROM with bonus tools
Euro 60,00



Waldorf Coffee Mug
Classic Blue colored with silver Waldorf logo and writing one mouth port
Euro 6,00



Waldorf T-Shirt "Coffee's ready..."
black, with stylish printing
available sizes: M/L/XL/XXL
Euro 13,00



Gekko Arpeggio *
Gekko Chord**
The reptile with arpeggio or chord memorizer function.
One button, one LED, MIDI In/Out, no external power supply necessary
* **Euro 76,00**
****Euro 51,00**



Zeitlos II
The latest ambient & electronic music CD from Waldorf Records. Previously unreleased tracks from Pete Namlook, DaDamn..aka Hardfloor, Pascal F.E.O.S. etc.
Euro 15,00

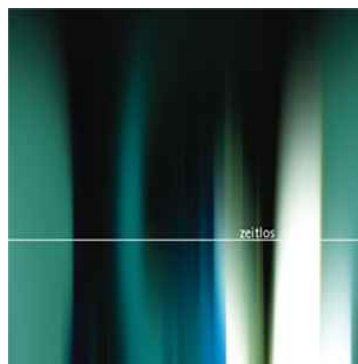

Zeitlos I
Timeless ambient and cill-out productions from artists like I Oliver Lieb, Pete Namlook, Astral Projection, Gabriel Le Mar etc.
All tracks are previously unreleased.
Euro 15,00



Subout
Still available: Independant Electronic Music from famous artists: Oomph!, De/Vision, Front 242, Wolfsheim, Frontline Assembly, Ernst Horn (Deine Lakaien) etc. Previously unreleased tracks.
Euro 10,00

All prices excluding shipment.
Order via Email, Fax or phone
info@waldorf-music.de
Phone +49 (0) 26 42-99 40-0 Fax -77

➤ Vielen Dank für den Kauf dieses Waldorf Produktes. Es zeichnet sich durch Zuverlässigkeit und Langlebigkeit aus. Dennoch können Material- oder Verarbeitungsfehler nicht völlig ausgeschlossen werden. Daher bieten wir Ihnen eine verlängerte Garantie. Damit Garantieleistungen in Kraft treten, müssen Kaufrechnung und Garantiekarte vollständig ausgefüllt innerhalb von 14 Tagen zurückgesandt werden. Diese Garantie erstreckt sich auf alle Defekte in Material und Verarbeitung für den Zeitraum von 1 Jahr ab Kauf des Produktes. Während der Garantiezeit ersetzt oder repariert Waldorf Electronics das durch Waldorf Electronics oder ein autorisiertes Service Zentrum als defekt befundene Produkt, ohne dem Kunden Material- oder Arbeitsaufwand in Rechnung zu stellen. Um die Garantie in Anspruch zu nehmen, muß sich der Kunde zunächst telefonisch mit dem zuständigen Vertrieb in Verbindung setzen. Produkte, die ohne vorherige Absprache eingesandt werden, können nicht kostenfrei ausgetauscht bzw. repariert werden. Das Produkt muß frei und versichert in Originalverpackung eingesandt werden. Detaillierte Fehlerbeschreibungen sind beizufügen. Unfrei und/oder nicht originalverpackt eingesandte Produkte gehen ungeöffnet zurück. Waldorf Electronics behält sich vor, das eingesandte Produkt auf den neusten Stand der Technik zu bringen, wenn dies erforderlich sein sollte. Diese Garantie deckt keine Defekte ab, die durch unsachgemäße Behandlung oder Eingriffe von unautorisierten Personen verursacht wurden und ist beschränkt auf die Behebung von Defekten, die während der normalen Nutzung durch Material- oder Verarbeitungsfehler aufgetreten sind.

➤ Thank you for choosing this Waldorf product. It is a dependable device and is designed to last. However, the potential for defects in material or workmanship cannot be eradicated completely. This is why we provide an extended warranty for you. To ensure your unit has full warranty coverage, mail the receipt and the fully completed warranty card back within 14 days of purchase. This warranty covers all defects in material and workmanship for a period of one year from the date of original purchase. During this time, Waldorf Electronics will repair or replace the product without charge for materials or labor, provided the product was first inspected and found faulty by Waldorf Electronics or an authorized service center. You must first contact your dealer or distributor by telephone. Products that were mailed without prior agreement cannot be exchanged or repaired free of charge. The unit must be insured and sent prepared in its original package. Please include a detailed description of the defect. Products that were not send prepared or in the original package will be returned unopened. Waldorf Electronics reserves the right to upgrade the unit with the latest technological advances if necessary. This warranty does not cover defects due to abuse, operation under other than specified conditions, or repair by unauthorized persons. The warranty covers only those malfunctions caused by material or workmanship defects that occur during normal operation.



Bitte schicken Sie die Garantiekarte vollständig ausgefüllt zusammen mit einer Kopie der Kaufrechnung zurück, um die Produktgarantie in Anspruch nehmen zu können.

Please fill out this warranty card completely, include a copy of the purchase receipt and send the two items to us in order to ensure the warranty is valid.

Waldorf Electronics
c/o Support
Schloß Ahrenthal
53489 Sinzig
Germany

Name / Name:

Straße / Street:

PLZ, Wohnort / ZIP Code, City:

Land / Country:

Telefon / Telephone:

Email:

Produkt / Product:

microQ Omega [O]
microQ lite [O]
microQ Keyboard [O]

Sonstige verwendete Geräte / Other used equipment:

Sonderausstattungen / Custom features:

Seriennummer / Serial number:

Kaufdatum / Purchase date:

Name Ihres Händlers / Name of your dealer:

Ort Ihres Händlers / City of your dealer:

Wenn Sie Fragen zu Ihrem Waldorf Produkt haben, gibt es vier Möglichkeiten, uns zu kontaktieren:

If you have any questions about your Waldorf product, feel free to contact us via one of the four options listed below.

1 Schicken Sie uns eine E-Mail. Das ist der mit Abstand effizienteste und schnellste Weg, uns zu erreichen. Ihre Fragen können sofort an die richtige Stelle weitergeleitet und innerhalb kürzester Zeit beantwortet werden.

info@waldorf-music.de

Send us an e-mail message. This is the most efficient and fastest way to contact us. Your questions will be forwarded immediately to the resident expert and you will quickly receive an answer.

2 Senden Sie uns ein Telefax. Fast so schnell wie E-Mail, allerdings für Sie und uns weniger komfortabel.

+49 (0) 26 42-99 40 77

Send us a fax. This is as fast as e-mail, but not quite as comfortable for you and us.

3 Schicken Sie uns einen Brief. Etwas langsamer, dafür jedoch genauso zuverlässig wie ein Telefax.

**Waldorf Electronics
Schloß Ahrenthal
53489 Sinzig, Germany**

Send us a letter. It will take a bit longer, but it is just as dependable as a fax.

4 Und wenn es ganz dringend ist, rufen Sie uns an. Wir versuchen, Ihre Fragen möglichst sofort zu beantworten.

+49 (0) 26 42-99 40 16

If you're in big hurry, call us, we'll try to answer your questions right away.



Foreword

Thank you for purchasing the Waldorf microQ, microQ Keyboard or microQ lite. You now own a synthesizer featuring a wide range of unique sounds from analog to digital.

To ensure your instrument functions properly and enjoys a long life, please read and heed the instructions in this manual.

Development

Software development:	Albert Huitsing, Stefan Stenzel
Hardware development:	Thomas Kircher
Design:	Axel Hartmann
Housing:	Frank Schneider
Factory Sound programming:	Wolfram Franke, Christian Halten, Uwe G. Hoenig, Jörg Hüttner, Tommy Kircher, Dirk Krause, Hubertus Maaß, Stefan Stenzel, Tsching, Eric Young
Manual:	Holger "Tsching" Steinbrink
English version proofing:	Amanda Pehke and Mark Pulver - RedMoon Music
Head:	Wolfgang Düren
Revision Date:	Version 2.18, May 2002 (mQ lite Vers. 1.38)

We would like to thank

Holger Bahr, Sigi Barishi, Steffi vom Berg, H.-P. "Bonni" Bonnenberg (†), Mike Carroll, Geoff Farr, Gunther Gräfe, Florian Gypser, Christian Halten, Martin Herbst, Jörg Hüttner, Thilo Kloft, Werner Kramer, Dirk Krause, Achim Lenzgen, Nicole Jasmin Moser, Wolfgang Mörs, Dr. Georg Müller, Martin Neideck, Stefan Profittlich, Norbert Reiß, Alex Sauff, Beate Walkowiak, Kurt "Lu" Wangard, KD Warnecke, Rocco Zodiac... and anyone we have forgotten.

Waldorf Electronics is not liable for any erroneous information contained in this manual. The contents of this manual may be updated at any time without prior notice. We made every effort to ensure the information herein is accurate and that the manual contains no contradictory information. Waldorf extends no liabilities in regard to this manual other than those required by local law.

This manual or any portion of it may not be reproduced in any form without the manufacturer's written consent.

Waldorf Electronics GmbH, Schloß Ahrenthal, D-53489 Sinzig, Germany

Control Features and Connections

Front Panel microQ Rackversion

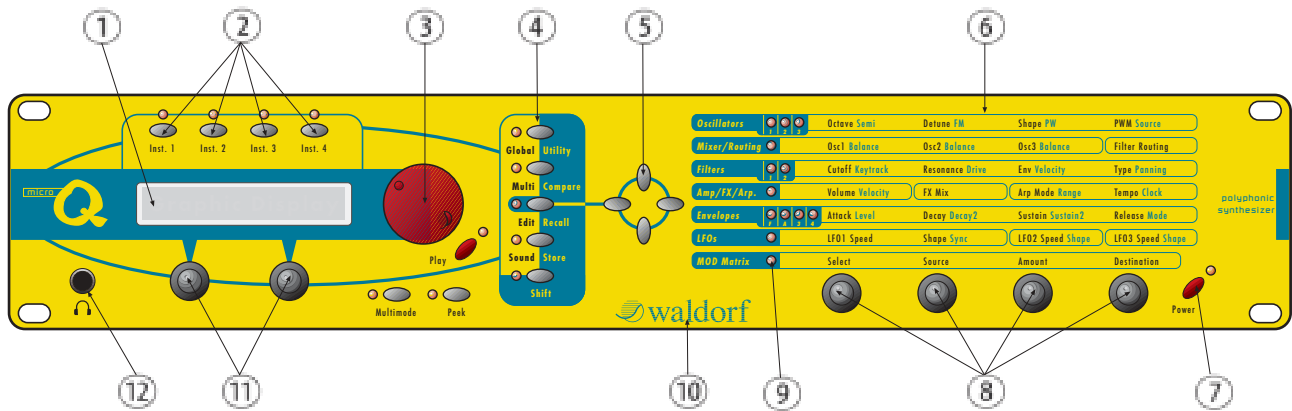

Picture 1: Front Panel microQ

- ① Display
- ② Instrument Select Buttons
- ③ Red Alpha Dial for Sound and page access
- ④ Master Section with function buttons
- ⑤ Navigation buttons
- ⑥ Parameter matrix
- ⑦ Power button with standby/MIDI indicator LED
- ⑧ Endless dials for parameter access
- ⑨ LEDs for showing the selected parameter section
- ⑩ German synthesizer manufacturer from the Schloss Ahrenthal
- ⑪ Display parameter dials
- ⑫ Stereo Headphone jack

Front Panel microQ Keyboard (additional controls)

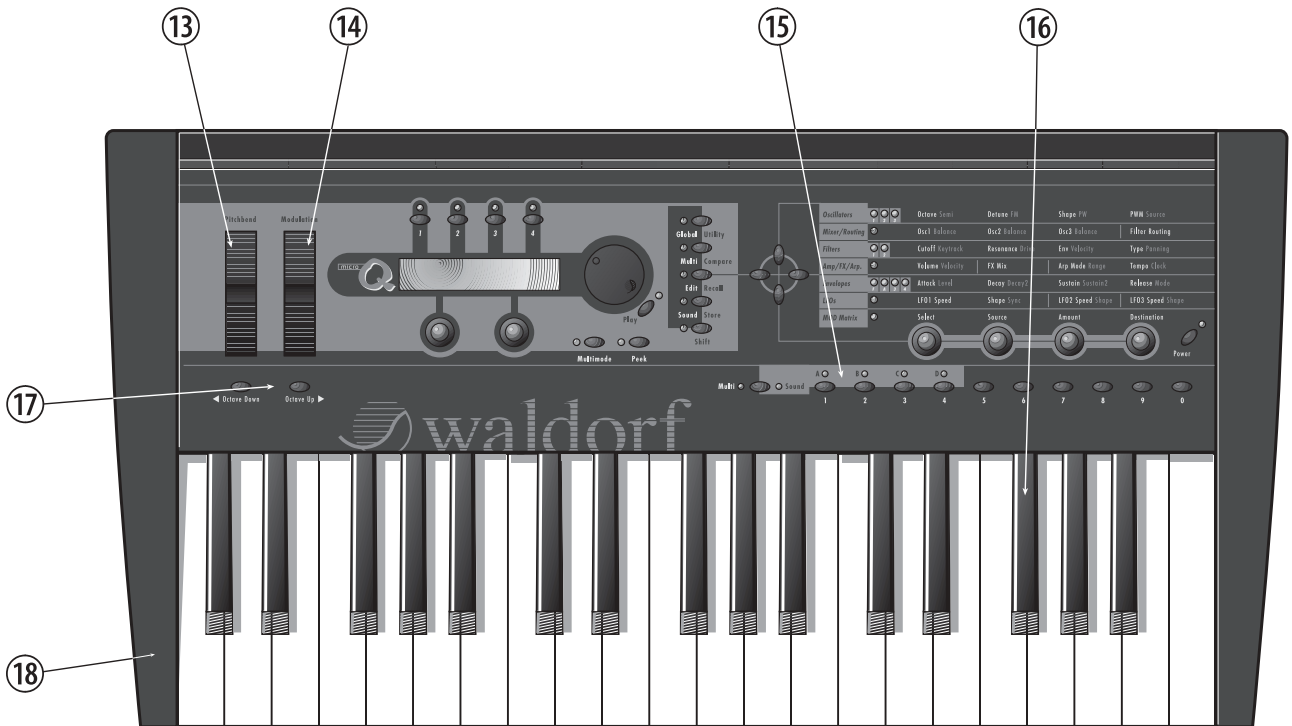

Picture 2: microQ Keyboard

- ⑬ Pitch Bend
- ⑭ Modulation Wheel
- ⑮ Program Select Section
- ⑯ 3-octave keyboard with aftertouch
- ⑰ Keyboard Transpose buttons
- ⑱ Full Metal Jacket

Rear Panel microQ Rack version

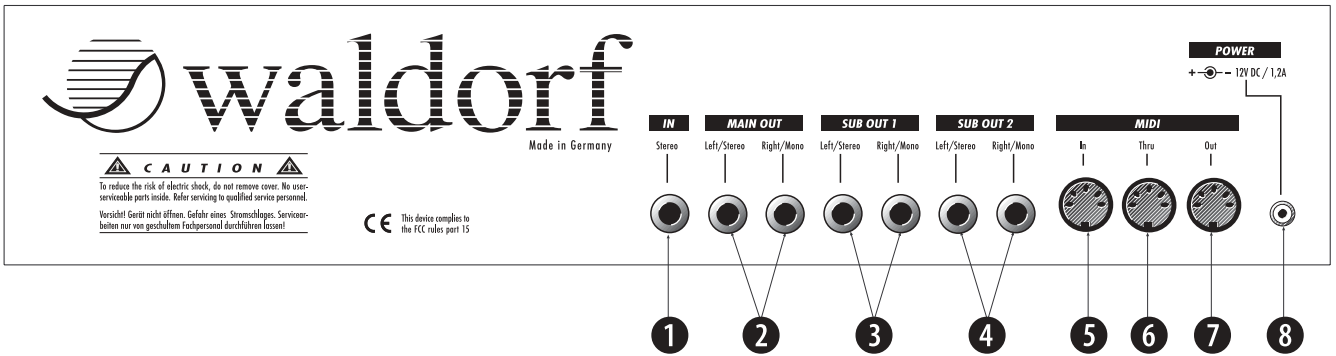

Picture 3:Rear Panel

- 1** Stereo External In jack for feeding external audio signals into the Mixer section.

2 Main Out jacks. Deliver a stereo line level output signal for connection to a mixing desk or amplifier.

3 Sub Out 1 jacks. Deliver a stereo line level output signal for connection to a mixing desk or amplifier.

4 Sub Out 2 jacks. Deliver a stereo line level output signal for connection to a mixing desk or amplifier.
- 5** MIDI In jack. Used to receive MIDI data from an external device.

6 MIDI Thru jack. Echoes MIDI data received at the MIDI In.

7 MIDI Out jack. Used to transmit MIDI data to an external device.

8 Power supply socket 100...240V AC

Rear Panel microQ Keyboard

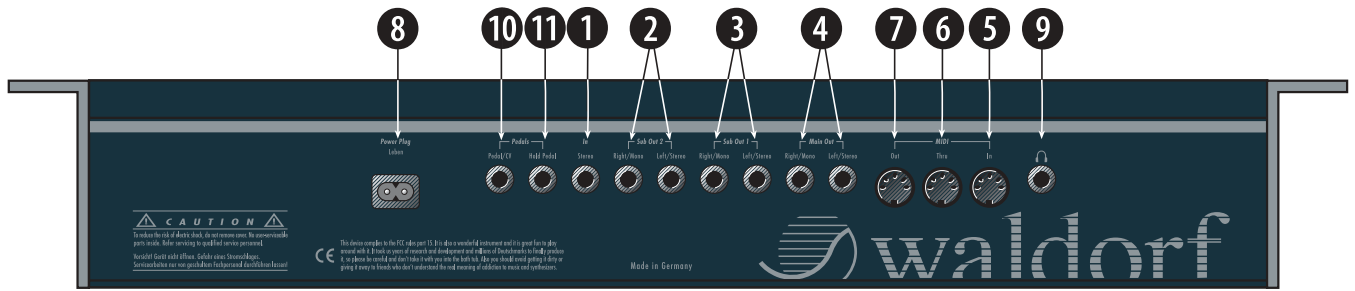

4. Rear Panel microQ Keyboard

- ❶ Stereo External In jack for feeding external audio signals into the Mixer section.
- ❷ Main Out jacks. Deliver a stereo line level output signal for connection to a mixing desk or amplifier.
- ❸ Sub Out 1 jacks. Deliver a stereo line level output signal for connection to a mixing desk or amplifier.
- ❹ Sub Out 2 jacks. Deliver a stereo line level output signal for connection to a mixing desk or amplifier.
- ❺ MIDI In jack. Used to receive MIDI data from an external device.
- ❻ MIDI Thru jack. Echoes MIDI data received at the MIDI In.
- ❼ MIDI Out jack. Used to transmit MIDI data to an external device.
- ❽ Power supply socket 100...240V AC
- ❾ Stereo Headphone jack
- ❿ Control Pedal/CV In jack for connecting foot controllers or analog control voltages
- ⓫ Hold pedal jack for connecting sustain pedals

Contents

Product information microQ series	3	Panic Function.....	25
Waldorf Merchandise	4	Tempo Indication.....	25
Warranty / Support.....	5	System Volume.....	26
Foreword	7	Demo Playback.....	26
Development.....	7	Demo Sequences	26
We would like to thank.....	7	The Master Section.....	27
Control Features and Connections.....	8	Selecting Programs	28
Front Panel microQ Rack version.....	8	Selecting Programs with the Page Dial	28
Front Panel microQ Keyboard	9	Fast Selection of Sound Banks in Single Mode ..	29
Rear Panel microQ Rack version.....	10	Selecting Programs with the Number Buttons ..	29
Rear Panel microQ Keyboard	11	Additional Switching Banks in the mQK.....	30
Contents	12	Category Search	30
Introduction	14	Instruments and Sounds	31
About this Manual.....	14	Switching between Instruments	31
Symbols.....	14	Creating Sound Layers with Instruments.....	31
Highlighted Control Features and Parameters ..	14	Replacing Sounds in Layers	31
What to read?	15	Editing Sounds in Layers.....	32
If you are new to the whole subject.....	15	Deactivating Sound Layers.....	32
If you have experience with synthesizers.....	15	Switching the Octave/Semitone Setting.....	32
If you are a synthesizer hotshot	17	Editing Parameters.....	33
General Safety Guidelines.....	18	Editing Parameter Controls.....	33
Suitable Operating Conditions	18	Editing Display Menu Parameter	34
Power Supply.....	18	Edit Buffers.....	35
Operation	18	Viewing Parameter Values without Change	35
Maintenance.....	18	Comparing Edited Programs.....	36
Proper Use.....	19	Recalling Edited Programs	36
Setup and Connection.....	20	Storing Programs	37
Inventory.....	20	Multi Mode	38
Setup	20	Selecting an Instrument for editing	38
Connections	20	Instrument settings	39
Audio Connections.....	22	Multi Mixer	44
External Input.....	23	Sound Parameters	45
Hold Pedal Input (microQ Keyboard only)	23	Overview of Functions.....	45
Control Pedal/CV Input (microQ Keyboard only) ..	23	Modulation Speed Levels	46
Overview.....	24	FM (Frequency Modulation).....	46
Memory Structure.....	24	Fast Modulation.....	46
Dynamic Voice Management	24	Standard Modulation	48
Basic Operation	25	Triggering of Voices.....	50
Switching on.....	25	Sound Edit Menu	50
Switching off.....	25	Oscillators Introduction	53
		Oscillator Shapes.....	53
		Oscillator Section.....	59
		Oscillator Parameter Controls	59
		Oscillator Edit Menu	64
		Mixer/Routing Section	68
		Mixer/Routing Parameter Controls.....	68
		Mixer/Routing Edit Menu.....	69
		Filter Introduction.....	72
		Filter Section.....	74
		Selecting and Editing Filters	74
		Filter Parameter Controls	74

Filter Edit Menu.....	76	Mod Matrix Edit Menu	122
Filter Types.....	78	Modifier Matrix.....	122
Bypass.....	78	The Tempo.....	124
24dB Low Pass and 12dB Low Pass.....	78	Drum Map	125
24dB Band Pass and 12dB Band Pass.....	79	Drum Map Sound Menu.....	125
24dB High Pass and 12dB High Pass	79	Global Parameters	127
24dB Notch and 12dB Notch.....	80	Global Menu.....	127
Comb+ and Comb-.....	81	Utility Menu.....	136
Amp/FX/Arp Section	84	MIDI Control.....	138
Amplifier Parameter Controls.....	84	Channel Based MIDI Messages.....	138
Amplifier Pages in the Amp/FX/Arp Edit Menu .	84	Modifying / Editing Sounds over MIDI	140
Effects.....	86	Controllers as Modulation Sources	140
Effect Parameter Controls.....	86	Changing Sound Parameters with Controllers	140
Effect Parameter of the Amp/FX/Arp Edit Menu	86	Changing Sound Parameters with SysEx Data	140
Bypass.....	87	System Exclusive Data Transmission.....	140
Chorus	87	Sending System Exclusive Data	140
Flanger	87	Receiving System Exclusive Data.....	141
Phaser	88	Other Functions	142
Overdrive	89	Updating the System Software.....	142
Five FX.....	89	Appendix	144
Delay	91	Tips & Tricks.....	144
Vocoder	93	Tips for better voice performance.....	145
Reverb.....	96	Parameter Index	146
Surround Delay Types.....	97	Technical Data	147
Arpeggiator.....	100	Glossary.....	148
Arpeggiator Parameter Controls.....	100	MIDI Controller.....	152
Arpeggiator Parameter of the Amp/FX/Arp Edit		MIDI Implementation Chart.....	156
Menu	101	CE Declaration.....	157
Arpeggiator Step Data Pages	105		
Envelope Section.....	108		
Envelope Parameter Controls	108		
ADSR Envelope	109		
ADS1DS2R Envelope	110		
One Shot Envelope.....	111		
Loop S1S2 Envelope	112		
Loop All Envelope	113		
Envelope Edit Menu	114		
LFO Section.....	115		
LFO Parameter Controls	115		
LFO Edit Menu	116		
Mod Matrix Section.....	121		
Mod Matrix Parameter Controls	121		

What to read?

The biggest problem with any manual is to find a way to cover both the needs of an absolute expert and a beginner alike. There are people who read a manual cover to cover while others don't even touch it. The latter is the worst choice, especially when the manual describes a Waldorf instrument. To ensure that everyone finds the information he needs to work with the microQ, we collected the following information to tell you which chapters you should read at the very least.

If you are new to the whole subject

Is this your **first or second** synthesizer? Then you should first read the whole manual once. You don't need to do that while you're exploring the microQ - you can also read it as you would read a good book. But read it. You don't need to understand everything but after you've read the manual, you know where to find a particular topic. Then it's time to go deep into the microQ and when you're stuck, you will find the answer quickly and easily.

Furthermore, we recommend the purchase of a good book explaining synthesizers and sound synthesis in general. This book might help you when you don't understand a certain term that is used in the manual. The appendix of the microQ manual contains a glossary but it is possible that you want or need even deeper explanation. A good book explaining analog sound synthesis named "Analog Sound Synthesis" can be obtained from the German publisher WIZOO. You can find further info about it and other books covering similar topics at:

<http://www.wizoo.com>

If you have experience with synthesizers

Do you own **a couple of** synthesizers, and have you edited some sounds to fit your needs? Then make sure to read at least the following chapters:

Section	Chapter	Sub-Chapter
Introduction	General Safety Guidelines	all chapters
Setup and Connection	Audio Connections	
Basic Operation	Switching off Panic Function	
	Selecting Programs	all chapters
	Instruments and Sounds	all chapters
	Editing Parameters	all chapters
Multi Mode	Multi Parameters	all chapters
	Instrument Parameters	all chapters

Sound Parameters	Dynamic Performance Management Modulation Speed Levels	all chapters
	Oscillators	FM and FM Source Wavetable Oscillators Pulsewidth PWM and PWM Source PitchMod and PitchMod Source Sync Keytrack Glide
	Mixer/Routing Section	Balance Routing RingMod Noise / Ext. Balance N/E Select F1 / F2 Feed
	Filter Section	Selecting and Editing Filters CutoffMod and CutoffMod Source FM and FM Source Drive Env Velo Pan PanMod and PanMod Source
	Filter Types	Notch Comb + and Comb -
	Amp/FX/Arp Section	Velo AmpMod and AmpMod Source
	FX	Global Effect Mix FX Types – Vocoder/Surround Delays
	Arpeggiator Edit Menu Tempo/Clock parameter	all chapters
	Envelope Section	Mode ADS1DS2R Envelope One Shot Envelope LoopS1S2 Envelope Loop All Envelope
	LFO Section	Sync Delay Keytrack Fade Clocked Phase
	Mod Matrix	all chapters
	Modifier Matrix	all chapters
	Drum Map	all chapters
	Global Parameters	Global Menu
MIDI Control	Channel Based MIDI Messages	Program Change Messages Poly Pressure Messages
	Influencing and Editing Sounds over MIDI	all chapters
	Other Functions	Updating the System Software

Table 1: Suggested chapters for advanced users

If you are a synthesizer hotshot

Do you own a **whole bunch** of various synthesizers of all flavors, analog, digital, sample playback, and know how to **create** and **modify** sounds, multis and other patch types on them? Do you already own any Waldorf synthesizers so that you are familiar with their structure and terminology. Then make sure to read at least the following chapters. They describe the extraordinary features and functions of the microQ.

Section	Chapter	Sub-Chapter
Introduction	General Safety Guidelines	Power Supply
Setup and Connection	External Input	
Basic Operation	Switching off Panic Function	
	Selecting Programs	Sound Selection by Category
	Instruments and Sounds	all chapters
	Editing Parameters	all chapters
Multi Mode	Multi Parameters	Ctrl W...Z
	Instrument Parameters	Selecting an Instrument for editing MIDI and Status Settings
Sound Parameters	Dynamic Performance Managment Modulation Speed Levels	
	Oscillators	FM and FM Source Wavetable Oscillators
	Mixer	Balance Routing Noise / Ext. Balance N/E Select F1 / F2 Feed
	Filter Section	Selecting and Editing Filters FM and FM Source Pan PanMod and PanMod Source
	Filter Types	Comb + and Comb -
	Vocoder	all chapters
	Arpeggiator Edit Menu Tempo/clock	all chapters
	Envelope Section	Mode ADS1DS2R Envelope One Shot Envelope LoopS1S2 Envelope Loop All Envelope
	LFO Section	Sync Fade Clocked Phase
	Mod Matrix	all chapters
	Modifier Matrix	all chapters
	Global menu	Sysex Device ID Clock Controller Send Input Gain

Table 2: Suggested chapters for synthesizer hotshot

General Safety Guidelines



Please read the following safety tips carefully! They include several precautions you should always observe when dealing with electronic equipment. Read all of the instructions before operating your device.

Suitable Operating Conditions

- Use the device in enclosed rooms only.
- Never use the device under damp conditions such as in bathrooms, washrooms or around indoor swimming pools.
- Do not use the device in extremely dusty or dirty environments.
- Make sure that adequate ventilation is available at all sides of the device.
- Do not place the device near heat sources such as radiators.
- Do not expose the device to direct sunlight.
- Do not expose the device to extreme vibrations.

Power Supply

- Never use a different power supply or cable than the one that came with the microQ.
- Never install a different plug. If the included power supply is not equipped with a suitable plug for your local sockets, take the microQ and the power supply to a qualified electrician.
- Unplug the device when you are not using it for longer periods.
- Never touch the plug with wet hands.
- Always pull the plug when unplugging the device, never the cable.

Operation

- Never place objects containing liquids on or near the device.
- Place the device on a stable base only. Use a suitable platform or rack.
- Make sure no foreign objects find their way into the chassis. If for some reason this should occur, switch the power off, unplug the device and consult a qualified repair center.
- This device, used on its own or with amplifiers, speakers or headphones, can generate volume levels that may do irreparable damage to your hearing. For this reason you should keep the volume at tolerable levels.

Maintenance

- Do not open the device or remove the cover. Refer all service and repair tasks to qualified personnel. The interior of the chassis contains no components that require user maintenance.
- Use only a dry, soft cloth or brush to clean the device. Never use alcohol, cleaning solutions or similar chemicals. They will damage the surface of the chassis.

Proper Use

This device is designed exclusively to produce low-frequency audio signals for the purpose of generating sound. Any other use is prohibited and voids the warranty extended by Waldorf Electronics GmbH. Waldorf Electronics GmbH is not liable for damages due to incorrect use.



Don't let your microQ beside children or animals. This could leads into critical interactions.

Setup and Connection

Inventory

The Waldorf microQ comes complete with:

- the microQ synthesizer (Omega, lite or Keyboard)
- external power supply or power cable (microQ keyboard)
- this manual including a inlaying warranty card on page 5

Please ensure all the items above were included. If something is missing, contact your local dealer.

We recommend that you save the original packing material for future transport.



Make sure you fill out the warranty card and send it to the appropriate distributor or the address printed on the card. This is the only way we can keep you informed of updates and upgrades. Other available services are listed on the warranty card.

Setup

Place the microQ on a clean, even surface. We recommended the installation in a stable 19" rack for the microQ rack version. If you choose to take the device on the road, we suggest transporting it in a special keyboard case, which should be available from your dealer.

Connections

In order to get started with your microQ you will need an AC power outlet, a mixing console, an amp and an audio monitor such as a speaker cabinet. The microQ rack version also needs to connect with a MIDI master keyboard.

You can also use a computer or sequencer to make use of the microQ's MIDI features.

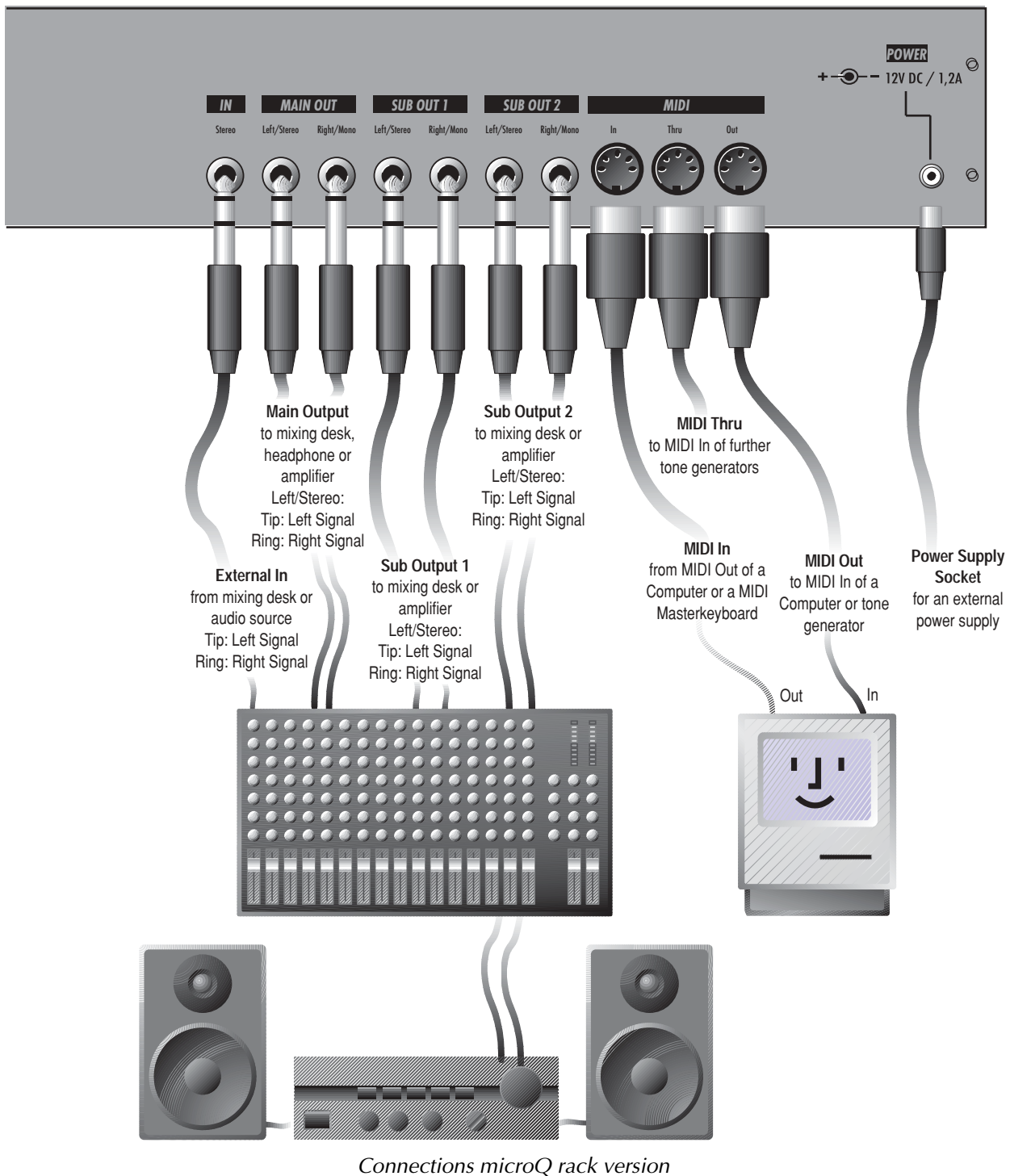

To connect the devices:

1. Turn all units off.
2. Connect the microQ's main audio outputs **Main Out 2** to your mixing console. Optionally connect the auxiliary audio outputs **Sub Out 1 3** and **Sub Out 2 4** too.
3. To play the microQ rack version you need a MIDI master keyboard. Connect its MIDI Out jack to the microQ's **MIDI In** jack **5**. Instead of this you can also connect the microQ to a MIDI computer system.
4. If you want to use a computer, connect your computer's **MIDI Out** jack to the microQ's **MIDI In** jack **5** and the computer's **MIDI In** jack to the microQ's **MIDI Out** jack **7**.

5. Connect the power supply cable or the power cable that came with the microQ with the **Power Supply 8** jack.
6. Plug the other side of the power supply cable or the power cable into a suitable AC power outlet.
7. The microQ should power up itself. If not, switch on the microQ with the **Power** button ⑦.
8. Then switch on the computer (if connected), the mixing console and finally the amplifier.



To check the correct reception of MIDI Data send any MIDI Events to the microQ; the Power LED lights up on any incoming MIDI Message. If this is not the case please check the MIDI connection to the microQ.

Audio Connections

The microQ provides three analog stereo audio outputs that can be used individually. All outputs are affected by the setting of the System volume control. If you choose to send only one mono or stereo signal to your mixer, use the **Main Out 2** jacks. You can connect each output stereophonically or monophonically as follows:



To connect an output stereophonically with two mono cables:

- Connect the Left and Right jack with 1/4-inch mono plugs.



To connect an output stereophonically with one stereo cable:

- Only connect the **Left/Stereo** jack of the output with a 1/4-inch stereo plug. Don't plug any cable into the **Right/Mono** jack of the output pair.



To connect an output monophonically:

- Only connect the **Right/Mono** jack of the output pair with a 1/4 inch mono plug. Don't plug any cable into the **Left/Stereo** jack of the output pair.

The microQ also offers a stereo headphone jack (⑫ microQ Rack versions; ⑨ microQ Keyboard). The signal on the headphone jack connector is always identical to the **Main Out** jacks.



The Main volume of the microQ can be changed with the endless knob left below the display while being in Play Mode. This function works in Single- and also in Multimode.



If you do not choose to connect a mixing console, you can patch the microQ's output signals directly to an amp. Use an input usually called Aux or Tape input.



Before connecting and disconnecting the microQ to a power supply source, turn your amp's volume control all the way down to avoid damage due to on/off switching noise. The microQ produces a high level output signal (see technical data). Please take care that the connected playback device is suitable for the high level of an electronic instrument. Never use the mic or phono input of the connected amp!

External Input

The microQ offers a stereo **External In** jack ① that can be used to feed an external signal into the mixer section. Therefore, the signal can be processed via the filters and the effects section in the same way as the oscillators.



As the external signal is treated like any other sound source within the microQ, it is necessary to trigger the Amplifier Envelope to get the signal passed through. To do so, notes must be sent to the microQ's sound generation, either by playing on the keyboard, receiving MIDI notes or via internal arpeggiator. The microQ Omega and the microQ Keyboard also have a **Mix In to** parameter in the **Global menu** which enables an external signal to pass through the FX section without triggering a MIDI note.

Hold Pedal Input (microQ keyboard only)

The microQ Keyboard features an input for a hold pedal ⑩. These hold pedal must be a so-called sustain pedal with an open state.

The Hold Pedal Jack ⑩ on the microQ Keyboard is a stereophonic 1/4 inch phono jack with a connection to +5V on the ring. You can connect a sustain pedal to it with a monophonic 1/4 inch phono plug.

Control Pedal/CV Input (microQ Keyboard only)

The microQ Keyboard features an input for a control pedal or control voltage.

If a control pedal is used, a potentiometer of 47 KOhms or higher is recommended. This covers almost any type of control pedal on the market. It doesn't matter in which direction the control pedal works, this can be adjusted in the **Global menu**.

If CV is used, make sure to match these specifications:

- Tip: CV in (internally connected to +5V by a 4K7 Resistor)
- Ring: internally connected to +5V by a 4K7 Resistor.
- Input Voltage Range: 0 to 5V

It doesn't matter if the incoming CV is linear or logarithmic, this can be adjusted in the **Global menu** as well as the initial offset and the overall gain.

Overview

Memory Structure

The memory architecture of the microQ is divided into three main sections as shown in the following picture. All memory locations are freely programmable, so there is no separation into preset and user programs.

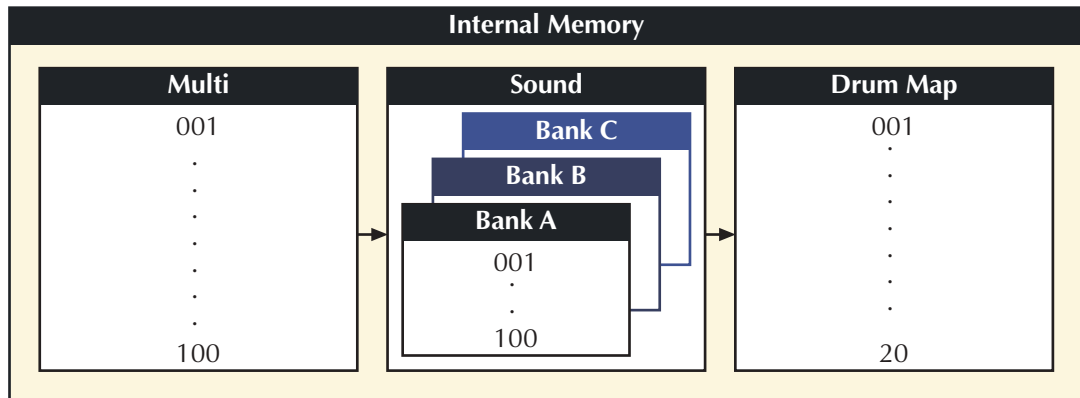

Memory Structure diagram

- 100 Multi programs (Multi 001...100)
A Multi program stores information about how up to 16 Sound programs sound at once.
- 300 Sound programs (Sound A001...C100)
A Sound program stores information about the character of a sound.
- 20 Drum Maps (Drum Map D001...D020)
A Drum Map contains up to 32 Single Sound Programs which can be organized on the keyboard.

Dynamic Voice Management

The microQ has a Dynamic Voice Management. This means that unused or deactivated parts of the Sound Engine, e.g. Oscillators, Filters, Effects, etc. do not need any CPU capacity. This enhances the following maximum polyphony:

- microQ Omega up to 75 voices
- microQ rack/Keyboard up to 25 voices
- microQ lite 12 voices

Further informations about this can be found in the chapter “Sound Parameters” under the corresponding parameters.



The simple rule of thumb says: the less complex the sound, the higher the available polyphony.



Tips for better voice performance can be found in the appendix on page 145.

Basic Operation

Switching on

The microQ is equipped with a software-based power control, which means that it is initially switched on when you connect it to an AC outlet, even if it was switched to standby mode before the power was disconnected. This enables you to switch the microQ on or off through e.g. a main power switch in your studio. However, if you switched the microQ off manually you can switch it on again with the following procedure:

 **To switch the microQ on manually:**

- Press **Power**  to switch the microQ on. The standby LED will go out.

After a couple of seconds the display will change, to show the last sound or multi program that was selected before the microQ was switched off. The microQ is now ready to be played:



```
Inst:1  Sound:A001
LosAngeles2019  T
```

Switching off

 The microQ has a special shutdown feature that prevents data loss by accidentally pressing the power button.

 **To switch the microQ off:**

- Press and hold the **Power** button . The display now shows a countdown message from 10 to 0:

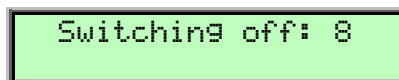



```
Switching off: 8
```

After counting down to 0 the microQ will switch off. If you release the **Power** button before, the shutdown process is cancelled.

Panic Function

The **Power**  button is also used to perform a Panic function. The Panic function sends and executes an "All Notes Off" command to terminate stuck notes. Panic immediately sets all envelopes to their release phases. Panic also stops the step sequencer and the arpeggiator playing when running in Hold mode.

To activate this function, briefly press **Power** .

When holding **Power**  a bit longer, all sound is suppressed and the release phases are cancelled.

Tempo Indication

In Play mode the LED of the **Amp/FX/Arp** section works as an indicator for the current selected tempo.

System Volume

In Play mode you can use the left parameter dial ⑪ under the display control to adjust the microQ's master volume. The volume setting is global and affects the levels of all audio outputs including the headphone output.

Demo Playback

The microQ is equipped with several demo songs to show some of its unique features. They should give you a quick overview of the microQ's sound character and the possibilities you can expect when you start working with your microQ. To listen to the songs in highest quality you should make sure that the microQ is connected stereophonically to a good amplifier/loudspeaker combination. Alternatively, you could use good headphones.

 **The Demo Playback mode clears all edit buffers. If you have made any changes to existing programs that you would like to keep, you should store them now. However, stored programs aren't affected in any way.**

 **To start the Demo Playback:**

- Press **Multimode** and **Peek** simultaneously to enter the demo mode. The microQ shows a selection of various demo songs.
- Press one of the highlighted **Instrument** ② buttons to listen to a particular demo song or press the **Play** button to listen to all demo songs in sequence.
- While you are listening to the music watch the display.

 **To play back another demo song:**

- Press another highlighted **Instrument button** ②.

If this gave you an idea of the microQ's capabilities of, it is time to leave the Demo Playback and to start exploring it yourself.

 **To exit the Demo Playback Mode:**

- Press **Peek** to exit the demo mode. The microQ returns to normal operation.

Demo Sequences

The microQ is equipped with four demo sequences. These demo sequences give you a way to hear the microQ without playing on the MIDI keyboard.

 **To play back a demo sequence:**

- Press **Peek** and one of the four **Instrument** buttons simultaneously to play back a demo sequence with the currently selected sound.
- Press another **Instrument** ② button to listen to a particular demo sequence.
- If you want, change the sound by turning the **Page Dial** ③.
- Press **Multimode** to stop the demo sequence playback. The microQ returns to normal operation.

The Master Section

Most of the basic operations like managing programs are done in the Master Section. The picture below shows the controls of the Master Section in detail:

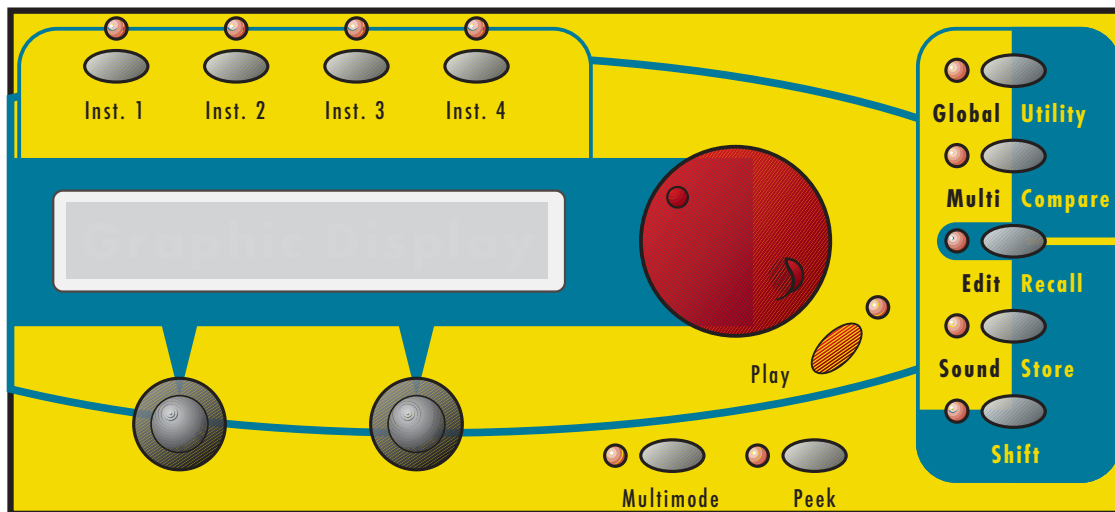

Picture 4: Master Section

As you can see, the Master Section consists of several controls:

- A 2x20 character display that shows program names, parameters and other messages.
- A red alpha dial on the right of the display. It is used to select sound programs or, when editing a program, to select a parameter page.
- Two value dials below the display for adjusting parameters currently shown.
- Four buttons labelled **Global/Utility**, **Multi/Compare**, **Edit/Recall** and **Sound/Store**. These buttons are used to call special parameter edit pages and to perform several utility functions.
- A button labelled **Shift** that is used to activate alternative functions of knobs and buttons, labelled in blue color.
- A button labelled **Play/OK**. Pressing this button will bring back the microQ to Play mode, where sounds can be selected.
- A button labelled **Multimode**. It is used to activate or deactivate the Multimode.
- A button labelled **Peek**. Pressing this button allows you to check parameter values without changing them.

Selecting Programs

The microQ offers three types of programs, Multis, Sounds and Drum Maps. To switch between them, you can either use the **Page Dial** ③ or the left parameter dial under the display (only in Play mode). The type of program changed depends on the microQ Single or Multi Mode status.

Single Mode

The Single Mode of the microQ consists of four Instruments that can be played one after the other or at once. This offers a fast way to switch between different sounds in a live situation or to create layered sounds in a studio session without deeper programming. We will come to that later. For now, you only need to know: The buttons **Inst. 1...Inst. 4** ② are used to switch between these Instruments. Each Instrument holds a Sound that can be selected in various ways.

In Single Mode, you can either select Sound Programs or Drum Maps. If you want to build a setup with a particular Sound *and* a related Drum Map, use the Multi Mode of the microQ.

Multi Mode

The Multi Mode of the microQ consists of 16 Instruments that can be mapped, layered or played individually. For a thorough explanation of the Multi Mode, read the chapter “Multi Mode” on page 38.

Selecting Programs with the Page Dial

With the **Page Dial** ③, you can select Multi programs in Multi Mode and Sounds in Single Mode.

☞ **To select a Program with the Page Dial ③:**

1. Make sure that the **Play** LED is lit. If not, press **Play** in the Master section.
2. If you are in Single Mode (**Multimode** LED is *off*), press one of the Instrument buttons **Inst. 1...Inst. 4** ② to select an Instrument that holds the Sound or Drum Map. The LED above the button lights up and the display content will change to show the current Sound for this Instrument.
3. Use the **Page Dial** ③ to select an appropriate Program. Turning the dial clockwise increases the Program number, turning the dial counterclockwise decreases it. When you are at the end of one Bank and turn the **Page Dial** ③ further, you will jump to the beginning of the next Bank and vice versa. The only exceptions are the first Program in the first Bank and the last Program in the last Drum Map Bank. The Bank names are:
Sound Bank **A** to **C**.
Drum Map bank **D**.
Multi Bank
4. The display shows the Program number in the top right corner and the name of the selected Program (name may be different depending on the factory set in your microQ).

Single Mode:

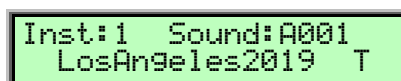

```
Inst:1 Sound:A001
LosAngeles2019 T
```

Multi Mode:

```
Inst:1  Multi:009
Venice Beach  T
```



Drum Maps can be found in sound position 01 to 20 in Bank D. The microQ can only hold up to 20 Drum Maps. Therefore higher storage positions aren't available.

Fast Selection of Sound Banks in Single Mode

In Play mode the Banks can be changed quickly by using the endless knob right below the display. Turning the knob clockwise raises the bank number, turning counterwise lowers it.

Selecting Programs with the Number Buttons (microQ Keyboard only)

At the microQ keyboard you can also use the program button section's number buttons to select a program. The following picture shows the program button section:



Program button section microQ Keyboard

To the left of the ten number buttons, you can see the **Multi/Sound** button. This button is used to set the program type that is switched by the number buttons.

Entering a two-digit number will select the corresponding program within the current bank.

Here are three examples:

- Entering **01** will call up Program number 001 in the current bank.
- Entering **99** will call up Program number 099 in the current bank.
- Entering **00** will call up Program number 100 in the current bank.



To select a Program with the Number Buttons :

1. Press the **Multi/Sound** button until the LED of the Program type you want to select lights up.
2. Press one of the Instrument buttons **Inst. 1...Inst. 4** ⑥ to select an Instrument that holds the Sound. The LED above the button lights up and the display content will change to show the current Sound for this Instrument.
3. Enter a two-digit number with the number buttons.
4. The display shows the Program number in the top right corner and the name of the selected Program.



Drum Maps are located at number 01 to 20 of bank D. You can't select higher a program number for this program type.

Additional Switching Banks in the microQ Keyboard

As described before the microQ's sound program memory consists of several banks, named "A" to "C". Each of these banks contains 100 Sounds, giving you a total of 300 sounds. The bank D contains 20 Drum Maps.

To switch between program banks in the microQ Keyboard:

1. Press and hold the **Multi/Sound** button.
2. Use the 4 leftmost numerical buttons to select the desired bank. These buttons are also labelled **Bank A** to **Bank D**. The program number will be retained when you change the bank. E.g. if program *A025* was selected before, pressing the **Bank C** button will select program no. *C025*. Take account that the Drum Map **Bank D** contains only 20 programs.
3. Release the **Multi/Sound** button again.

Category Search

The microQ offers a special function to enable easy searches for sounds of similar categories. If you're searching for pad sounds, only these sounds will be displayed as you scan the storage banks with the red dial. To accomplish this each sound contains 4 extra digits in the sound name to define its sound category. Further details about how to change a sound's category are described in the chapter „Storing Programs“ on page 37.

Searching for a special sound category:

1. Hold down the **Shift** button
2. Chose a category with the red dial. The following message shows up on the display:



```
[Sel. Category:Pad ]
```

3. Release the **Shift** button
4. Use the red dial to scroll through the patches of the selected category

 With the category search function activated, the microQ scans its entire storage bank for only those type of sounds. This can lead to short waiting periods.

Switching off Category Search:

1. Hold down the **Shift** button.
2. Turn the red dial clockwise until the display shows:



```
[Sel. Category:----]
```

3. Release the **Shift** button.

 Category Search doesn't change any program numbers. It only filters out all patches not belonging to the selected category. Scrolling through patches with this function is much faster because only patches belonging to the selected category are visible.

Instruments and Sounds

Switching between Instruments to change Sounds

As mentioned before, the Single Mode of the microQ uses four Instruments that can be accessed through the buttons **Inst. 1...Inst. 4** ②.

In a live situation, for example, you can set up the Sounds for the Instruments in advance and quickly switch to them during your performance.

Or, in a studio session, you can try out several Sounds by switching the Instruments back and forth. This is also interesting when working with MIDI. In Single Mode, only the active Instrument (or Sound Layer) responds to MIDI.



To select one instrument:

- Press one of the Instrument buttons **Inst. 1...Inst. 4** ②. The LED above the button lights up and the display content will change to show the settings for this Instrument.
- You can now play the Sound of this Instrument.



There's no way to store the settings of the four Instruments permanently except when you create a real Multi in Multi Mode. So, see the Instruments as temporary scratch pads.

Creating Sound Layers with Instruments

Beside the feature to select the four Instruments in sequence, you can select two or more Instruments at once to create Sound Layers. This is very handy and allows you to build up big sounds without any deeper programming as you would have to do in Multi Mode. However, if you are very happy with a Sound Layer, you should think about building a Multi with the same settings to store it permanently.



To create a Sound Layer by selecting several Instruments at once:

1. Set up the Instruments to hold the Sounds that you would like to play.
2. Press and hold one of the Instrument buttons **Inst. 1...Inst. 4** ②. The LED above the button lights up and the display content will change.
3. Press additional Instrument buttons briefly. The Instruments will be added to the other Instruments as long as you hold the Instrument button you've pressed first. The respective Instrument LEDs light up half as bright to indicate that these Instruments are added.
4. Release the Instrument button you pressed first.
5. The LED of the Instrument you selected first will light fully to indicate that this is the editable Instrument. All other selected Instrument LEDs are dimmed.

Replacing Sounds in Layers

If you are not happy with one Sound of your Sound Layer, you can replace it at any time with a different Sound.



To replace one Sound of a Layer:

1. Press the Instrument button **Inst. 1...Inst. 4** ② that holds the Sound you want to replace. The LED above the Instrument button lights up fully.
2. Select a Sound for this Instrument.

Editing Sounds in Layers

You can edit individual Sounds in Layers. This helps you to fine-tune a Sound to match it to the sound character of the Layer.

 **To edit one Sound of a Layer:**

1. Press the Instrument button **Inst. 1...Inst. 4** ② that holds the Sound you want to replace. The LED above the Instrument button lights up fully.
2. Now you can edit the Sound with the panel controls and its menus.

Deactivating Sound Layers

 **To deactivate a Sound Layer:**

- Press all Instrument buttons **Inst. 1...Inst. 4** ② that make up the Sound Layer.
or
- Press an Instrument button **Inst. 1...Inst. 4** ② that isn't part of the Sound Layer.

Switching the Octave/Semitone setting on the microQ Keyboard

The microQ keyboard features a built-in 3 octave keyboard that can be used to play internal sounds as well as to generate MIDI notes for external devices. As a default, C1 is the lowest note on the keyboard, C3 is the middle note and C5 is the highest. To cover a wider octave range, the whole keyboard can be shifted one or more octave/semitone up or down via the corresponding buttons ⑰.

 **This is how you change the keyboard's octave setting:**

1. Press the **Octave Down** button. The keyboard is shifted one octave down by each pressing. The corresponding transposition is shown in the display.
2. Press the **Octave Up** button. The keyboard is shifted one octave up by each pressing. The corresponding transposition is shown in the display.
3. To return to the default setting, press **Octave Down** and **Octave Up** simultaneously. Now the range is from C1 to C5 again.

 **This is how you change the keyboard's semitone setting:**

1. Press **Shift + Octave Down** button. The keyboard is shifted one semitone down by each pressing. The corresponding transposition is shown in the display.
2. Press the **Shift + Octave Up** button. The keyboard is shifted one semitone up by each pressing. The corresponding transposition is shown in the display.
3. To return to the default setting, press **Octave Down** and **Octave Up** simultaneously. Now the range is from C1 to C5 again.



Please take into consideration that a simultaneous use of the octave and semitone transposition will influence the overall keyboard range setting. E.g. if you shift the keyboard 2 semitones up and then make an octave shifting of one octave (12 semitones) the overall shifting will be about 14 semitones.

Editing Parameters

In order to change or edit a program in the microQ, you must access the appropriate parameters. In spite of the microQ's compactness it uses a sophisticated user interface allowing a fast editing of any parameter. The change of any value is done with the so-called endless rotaries.

The rotary knobs control parameters with continuous values. All rotary controls consist of dials. Turning a dial clockwise increases the corresponding value; turning it counterclockwise decreases it. The dials have a built-in dynamic response feature. If you turn the control slowly, the value changes very smoothly, too. If you turn it faster, it accelerates as well. This gives you the chance of adjusting the whole value range in just one turn without losing accurate control when necessary. Bipolar parameters (parameters with positive and negative values) use special gradation when changing their values. As soon as the value 0 is reached, the sweep is stopped for a short period to make it easier to edit the microQ.

Editing Parameter Controls

The basic programming of the Waldorf microQ is done via the so-called parameter matrix ④ which has its most important parameters silkscreened on the machine's front panel. Changing the parameters is done with the four endless rotaries ⑧ on the bottom of the matrix. Changing the edit level is done with the four navigation buttons ⑤ left to the parameter matrix. This sounds more complex than it is. With a simple example you will understand the structure of the microQ handling easily:

Would you like to change the **Resonance** of Filter 2? Please proceed as follows:

☞ **To access a specific panel parameter:**

1. Locate the section that contains the desired parameter on the front panel. For example, if you want to change **Resonance** of Filter 2, refer to the Filter section. To do this please press the upper or lower navigation button until the LED lights up in the Filter section.

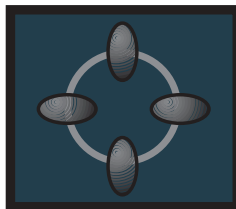

2. With the left or right navigation button you can choose Filter 2. The LED will show the currently selected Filter.
3. With the second endless rotary you can now change the **Resonance** value of **Filter 2**.

Whenever you change a parameter by moving a knob or pressing a button, the display shows the edited parameter and its current value in the upper right corner for a few seconds:

```
[F2 Resonance 016]
Nimm Del!      T
```

If you wish to edit a shift-parameter (printed in grey next to the main parameter) you need to keep the **Shift** button pressed or push it briefly. If pressed briefly the LED next to the shift button will keep lighting up until you press it again to edit the main parameters again.

Now you should be able to choose the 7 edit levels with the navigation buttons:

Oscillator, Mixer/Routing, Filter, Amp/FX/Arp., Envelopes, LFOs and Mod Matrix

For each parameter level you can also access an edit menu, since only the most important parameters can be directly accessed through the parameter matrix. To activate the edit menu of the selected section simply press the **Edit** button in the master section to edit all additional parameters in the microQ's display.

Editing Display Menu Parameter

There are display menus for all sections of the parameter matrix. The display menus contain additional parameters that are not directly accessible from the front panel. You can reach these menus by pressing the **Edit** button in the master section.

 **To access a specific display menu parameter:**

1. With the navigation buttons you choose the parameter section you wish to reach. For instance, if you wish to edit the **Keytrack** of any Oscillator please choose the **Oscillator** section in the Parameter matrix.
2. Press the Edit button of the Master section.
3. The first page of the oscillators' display menu will appear. If you did some editing in this menu before, the display may show another page. This happens because the microQ remembers the state of each display menu:



4. Use the page dial to scroll through the menu. Turning the dial clockwise selects the next page, turning it counterclockwise selects the previous page. You can also press the **Edit** button again to select the next page.
5. Use the value dials below the display to adjust the corresponding parameters. Some display menus consist of only a single parameter. Only the leftmost value dial will be active then.
6. After finishing all edits, press the **Play** button in the Master section to return to normal mode.

 While editing display menu parameters, you can also adjust panel parameters and vice versa.

In addition to the **Edit** button, three other buttons located on the right hand of the Master section allow you to set up further parameters:

- The **Global** parameters provide the basic settings of the microQ, valid for all programs.
- The **Multi** parameters refer to a Multi program. They determine the common setting for all instruments in the Multi program. Obviously, you can access these parameters only when the microQ is in Multi mode.
- The **Sound** parameters refer to a Sound program. If you are in Single Mode, you will edit the currently played program. If you are in Multi mode, the Sound program for the currently selected Instrument will be edited. Here you can program the parameter of a Drum Map, too.

The procedure for setting up these parameters is the same as for adjusting the other display menu parameters described above.

When you have finished all your edits, you should store the program. Please read the chapter on page 37 about storing programs for further information.

Edit Buffers

Whenever you edit a program on the microQ, the program is internally copied to an edit buffer. When you use the **Store** function to save the edits, the program is copied back from the edit buffer to the internal memory. The display shows an **e** behind the program number for every program that is actually in an edit buffer:

```
Inst:1  Sound:A001e
Zeitlos T
```

The microQ has a number of different edit buffers, each holding a program of the specific type when you edit them:

- 1 Multi edit buffer:
This buffer holds the currently selected Multi in Multi mode.
- 1 Drum Map edit buffer:
This buffer holds the currently edited Drum Map in single or multi mode.
- 16 Sound edit buffers:
Each buffer holds an edited Sound.



The edit buffers aren't cleared when you select a different program so you can always go back to the edited program to examine it or do further edits. The only way to "lose" an edit buffer automatically is when all buffers of this type are already in use and you start to edit another program. Then the oldest edit buffer is cleared and used to hold the new edit.



Note that all edit buffers are cleared when the microQ is switched off. Use the Store function as soon as possible after finishing your edits.

Viewing Parameter Values without Change – Peek

The microQ offers a special mode to check parameter values without performing any changes.



To check parameter values without changing them:

1. Press the **Peek** button, located in the Master section. The LED beside this button will light up.
2. If you move the control element of any panel parameter, its current value will be shown in the display. E.g. if you move the **Detune** knob in the Oscillators section, the display will show (value may be different):

```
[01 Detune +09]
```

3. After a few seconds, the display will return to its previous state. You can also check the various display menu parameters. Press the **Edit** button and scroll through the display menu via the **Page Dial** or by pressing the **Edit** button repeatedly. This procedure is also applicable to the display menu parameters of the **Global**, **Multi** or **Sound** menus.
4. Press the **Peek** button again. The LED beside the button will go off, indicating that peek mode has been terminated.



If you don't check any parameters for a certain time, the Peek mode will be terminated automatically.

Comparing Edited Programs with Stored Programs

The Compare function allows you to compare the currently edited program to its original stored version in the internal memory.

 **To use the Compare function:**

1. Choose the program type to compare as follows:
 - If you want to compare a **Sound**, select the **Play** page or any of the **Edit** menus.
 - If you want to compare a **Multi**, select the **Multi** page.
 - If you want to compare a **Drum Map**, select the **Drum Map Edit** menu.
2. Press **Shift + Compare**.
3. The display now shows a **c** after the program number:

```
Inst:1  Sound:A001c
Zeitlos T
```

4. You will hear the unedited version of your program when you play the microQ.
5. Press the **Shift + Compare** again.
6. The **c** in the display changes to **e** again. The edited version of the program is now active again.

 You can only view the original settings. If you select a new program while the Compare function is active, the Compare status is automatically terminated. No parameters can be edited with the Compare function active. Any attempt will give you an error message in the display:

```
[Compare active]
```

Recalling Edited Programs

You can void edits at any time and return to the original program.

 **To recall an edited program:**

1. Choose the program type to recall as follows:
 - If you want to recall a **Sound**, select the **Play** page or any of the **Edit** menus.
 - If you want to recall a **Multi**, select the **Multi** page.
 - If you want to recall a **Drum Map**, select the **Drum Map Edit** menu.
2. Press **Shift + Recall**.
3. The **e** or **c** in the display after the program number will disappear. All edits will be recalled and the program returns back to its stored state.

Storing Programs

After you have finished editing a program, you must store it if you intend to use it again. Any of the microQ's memory locations are available for this purpose. The type of program that is stored depends on the page you were in before performing the Store function.

To store a program:

1. Choose the program type to store as follows:
 - If you want to store a **Sound**, select the **Play** page or any of the **Edit** menus.
 - If you want to store a **Multi**, select the **Multi** page.
 - If you want to store a **Drum Map**, select the **Drum Map Edit** menu.
2. Press **Shift + Store** to activate the Store page.
3. The display shows the Store page where you can select the destination and the program name:



```
Store Sound to A051
01[Nimm Oel! T]
```

4. Use the page dial to select the destination program. The default value is the currently selected program but you may want to store your edits in a different location. In this case the name of the chosen Sound Program is temporarily shown and you can choose to overwrite the old sound or not.
5. Optionally, edit the program name. First select the character to be modified via the first value dial. Then change its setting via the second value dial. The program name can use up to 16 characters.
6. When the cursor is on the 16th character and you scroll it even further to the right, you will come to a second page where you can change the category of the sound. It is strongly recommended to select an appropriate category for your sound or to create a new category. This helps you finding your sound later. You can get infos on how to search for a Sound category in the chapter "Category Search" on page 30. This is how the display looks:



```
Store Sound to A001
01[Pad ] <-category
```

7. Press **Shift + Store** to store the Program to the selected location.



Whenever you store a program, the selected memory location is overwritten. Therefore, any previously stored program at this location will be erased and there is no way to get it back. So, you should do backups of the sounds, multis and Drum Maps regularly. If you want to restore the factory presets, you can download them as a Standard MIDI File from our website <http://www.waldorf-music.com>.

You now have stored the program. When you activate the Store function, the Edit or Compare status of the stored program is terminated.

By pressing any button before performing the last step, you can discard the Store process at any time.



Use the Store function also if you want to copy programs. There is no need to edit a program before storing it.

Multi Mode

The Waldorf microQ offers a 16 part Multi mode. As soon as you want to arrange keyboard layers for a live performance or want to do multi track recordings in a studio, you should start to program your own Multis that you can use to quickly switch between completely different setups.

Only a Multi combines the various sections of the microQ like Sounds, MIDI In/Out Channel settings, or audio output routings. The following picture shows the structure of a Multi.

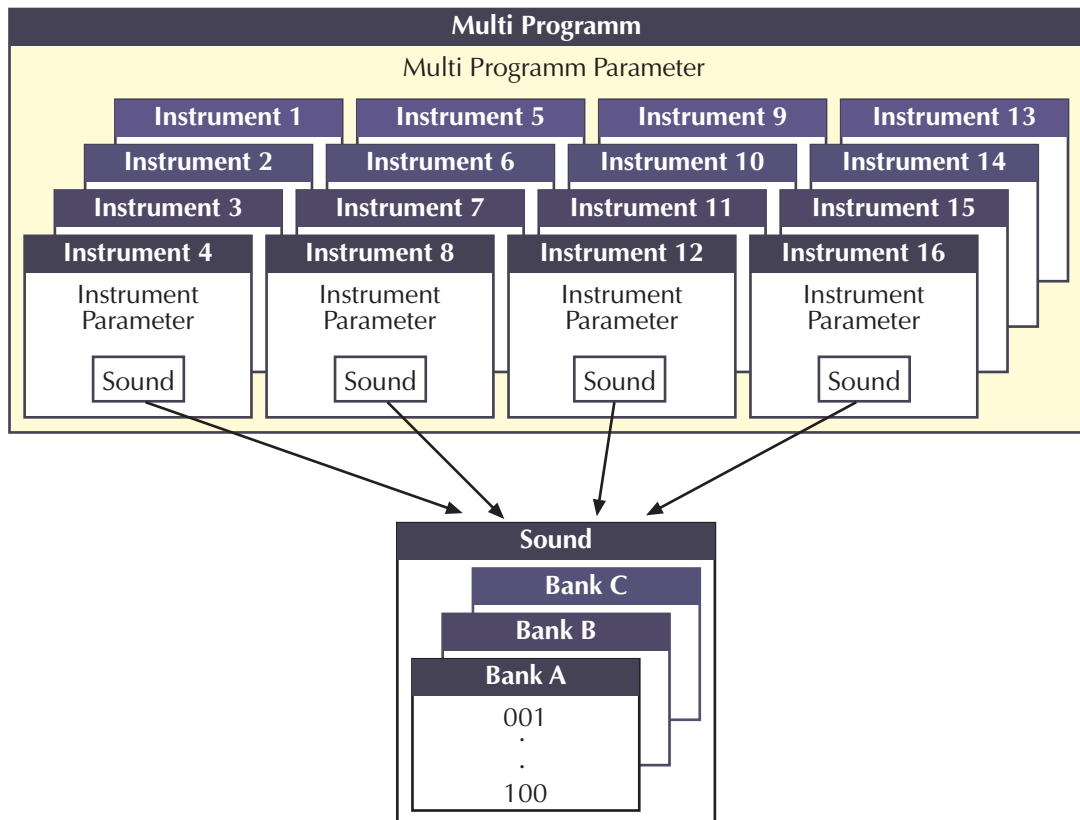

Picture 5: Multi Program architecture



Setting up a Multi requires some organizational work, as it does on all synthesizers, but you should do it anyway because it eases your work with the microQ when you use it live or for recording.

Selecting an Instrument for editing

Before you can adjust the Instrument Parameters of a particular Instrument, you have to select it. The Multi mode of the microQ offers 16 Instruments that can be played at a time via MIDI. The 16 Instruments are organized into 4 banks with each 4 Instruments.



To select an Instrument:

1. Press **Shift+Inst. 1...4** ② to select one of the four Instrument banks.
2. Press **Inst. 1...4** to select one of the Instruments of the selected bank.

or

1. Hold down the **Multimode** button.
2. Choose the desired instrument with the red dial.

When the Play page is selected, the display shows the Instrument number in the top left corner as follows:

```
Inst:4   Multi:001
Sequencer Multi
```

The instruments are numbered consecutively from **1** to **16**. In the display shown above, Instrument 4 is selected. If you want to select Instrument 12, for instance, you have to access Bank 3 by pressing **Shift + Inst.3** ② and then button **Inst.4** to switch to Instrument 12.

When one of the Instrument parameter pages is selected, the current Instrument number is shown in the top right corner as follows:

```
Channel |Output  4
global  |Main Out
```

i Don't confuse Instruments with MIDI Channels. Although you can set up a Multi that uses separate MIDI Channels in ascending order for all Instruments, it can also be that a couple or all Instruments are set to the same MIDI Channel. Please read the description below to see how the MIDI Channel for a particular Instrument is set.

☞ **To call the Multi parameter pages:**

1. Make sure that the **Multimode** LED is lit to indicate that the Multi mode is active.
2. Press the **Multi** button in the Master section. The display changes to the **Multi** or **Instrument** parameter page that was active when you last left the Multi parameter pages the last time.
3. You can change the pages with the red page dial or by pressing the **Multi** button several times.

Instrument settings

The instrument parameters specify the individual settings of each instrument in a Multi Program. You can edit the audio output, transpose function or tuning, key range and velocity range for a selected sound.

Sound Bank and Number

A...D 001...100

Each Instrument points to one Sound in memory. The display shows the Sound name in the upper row and the Sound bank and number in the lower row as follows:

```
[Nimm Oel!   T ]1
Bank: A sound: A001
```

☞ **To select a Sound for an Instrument:**

- Use the **left display dial** to select *Bank A...D* from which the Sound program is taken.
- Use the **right display dial** to select the Instrument's Sound program *001...100*.

i In a Multi-Program you can use only one Drum Map at a time. When you're assigning a Drum Map to an instrument, any other instrument using a Drum Map will be restored to the normal program assignment.

```
Volume !Panning 1
100 ! center
```

Volume *000...127*

Volume sets the output volume of the selected Instrument.

i This **Volume** parameter sets the maximum output volume of the selected Instrument. If you use MIDI Controller #7 (Channel Volume) to change the volume of the Instruments that receive on this MIDI channel, the real output level is scaled to the volume set up in this parameter. This means that if you set Instrument **Volume** to *10* and Controller #7 to *127*, the maximum output volume is *10*.

Panning *left 64...center...right 63*

Determines the panning position of the selected instrument. The setting *left 64* stands for full left, *right 63* for full right. In case you want to have the sound in the mid position select *center*.

With this function you can set the stereo outputs of the microQ to mono outputs by selecting the full left or full right position for the panning.

i If stereo effects are active, e.g. delay, the effect will still sound in both outputs even if the basic sound is set to full left or full right.

```
Channel !Output 1
01 !Main Out
```

Channel *global, omni, 1...16*

Channel sets the MIDI Channel for the selected Instrument. This MIDI channel is used to send MIDI messages and to receive MIDI messages for this Instrument when **Status** is set to *Midi*.

- *global* means that the selected Instrument receives and sends on the MIDI channel set up in the **Global** menu. This setting is recommended for a Multi that is intended for use in a live performance.
- *omni* means that the selected Instrument receives all MIDI channels and sends on the MIDI channel set up in the **Global** menu. This setting is not recommended. Only use it for diagnostic purposes when you need to know if the microQ receives any MIDI messages at all.
- *1...16* means that the selected Instrument receives and sends on this MIDI channel. This setting is recommended for a Multi that is intended for multi track playback with a software sequencer.

Output *Main Out, Sub Out 1, Sub Out 2, FX1, FX2, FX3, FX4, Aux*

Output sets the audio output of the selected Instrument. The Instruments **1...4** can only be routed to the physical outputs, the Instruments **5...16** can also be routed to the effect busses of the Instruments **1...4**.

This routing is not possible for a Drum Map.

- *Main Out* means that the selected Instrument plays over the **Main Out ②** jacks.
- *Sub Out1* means that the selected Instrument plays over the **Sub Out 1 ③** jacks.

- *Sub Out2* means that the selected Instrument plays over the **Sub Out 2**  jacks.
- *FX1...FX4* (only available on Instruments **5...16**) means that the selected Instrument is routed to the respective effect bus of Instrument **1...4** and therefore also plays back over the same physical output.
- *aux* means that the selected instrument is routed to the internal audio bus. So you can use this Instrument to feed the 5 FX or the vocoder. For more information refer to the chapter "Effects" on page 89 and page 93.

 The Instruments **1...4** define the effects that are used in the selected Multi. All other Instruments are played back without effects unless you route them to one of the effect busses *FX1...FX4*. If you do so, these particular Instruments automatically use the same physical outputs that are set up in the respective Instrument **1...4**.

 If you have chosen *aux* for an instrument you don't hear its audio signal on the physical outputs.

Status

Off, Midi

```
Status 1
Midi
```

Status sets the send and receive status of the selected Instrument. This means whether the Instrument can be played by MIDI or is disabled.

- *Off* means that the selected Instrument is disabled.
- *Midi* means that the selected Instrument can be played by MIDI.

```
FX1 Mix ! FX2 Mix
064 ! 000
```

FX1/2 Mix

000...127

FX1 and FX2 Mix control the volume ratio between the original signal and the effect output of the selected instrument. If set to *0*, the dry signal is sent to the outputs only so that no effects can be heard. Higher values will increase the effect signal. At maximum setting, the pure effect signal will be heard.

 **FX1 Mix** is only available for Instrument 1...4. **FX2 Mix** is available for all 16 instruments. In the Global menu **FX2** can be assigned either globally or to Instruments 1 through 4. Please also see the chapter "Global Menu" on page 130.

```
Transpose | Detune 1
+00 | +00
```

Transpose

-48...+48

Transposes the Instrument in semitone steps. I.e., a value of *-12* means that the Instrument sounds one octave lower than it was originally programmed.

Detune -64...+63

Detunes the Instrument in steps of 1/64th of a semitone.

 You can set up nice layered sounds with **Transpose** and **Detune**. Activate two Instruments and set their parameters to identical values including the sound number. Then simply transpose one Instrument by one octave, and you have a fat layer sound. Or set them both to the same octave and set **Detune** of one Instrument to *-05* and the other to *+05*.

```
LowVelo |HiVelo  1
001    | 127
```

LowVelo 001...127

LowVelo allows you to limit the velocity range in which the instrument is played. Only notes with a velocity higher or equal to the selected value are passed through. Set this parameter to *1*, if you want to turn velocity switching off.

HiVelo 001...127

HiVelo is the counterpart to **LowVelo**. Only notes with a velocity lower or equal to the selected value are passed through. Set this parameter to *127*, if you want to turn velocity switching off.

```
LowKey   |HighKey  1
C-2     | G8
```

LowKey C-2...G8

Analogous to the velocity switching parameters, the key range can be restricted for the instrument's tone generation. Only notes with a key number higher or equal to the selected value are passed through. Set this parameter to *C-2* if you want to use the full keyboard range.

HighKey C-2...G8

HighKey is the counterpart to the **LowKey** parameter. Only notes with a key number lower or equal to the selected value are passed through. Set this parameter to *G8* if you want to use the full keyboard range.

Ctrl W...Ctrl Z 0...120

```
Ctrl W |Ctrl X  1
002 (02) |004 (04)
```

```
Ctrl Y |Ctrl Z  1
011 (0B) |012 (0C)
```

These parameters are used to define arbitrary MIDI Continuous Controllers as modulation sources for the Sounds in the active Multi. You can set up four Controls, W, X, Y and Z, for this purpose. Each value represents a MIDI Continuous Controller number that is used when you assign its parameter as modulation source in the Modifiers or the Modulation Matrix. The highest possible Controller number is *120* because all higher numbers are reserved for non-real-time purposes. If *global* is selected, the corresponding settings for **Ctrl W...Z** made in the global parameter section are used.

i The most important Sound parameters of the microQ can be controlled by MIDI Continuous Controller messages. If you set one of the Ctrl W...Ctrl Z to a Controller that is also used for a Sound parameter, the microQ disables this Controller as Sound parameter Controller and uses it exclusively for one of the Ctrl W...Ctrl Z.

This is an important issue when you send Sound parameter changes by tweaking parameters on the front panel. The Sound parameter is sent out as Controller but can't be received as long as any of the Ctrl W...Ctrl Z remains assigned the same Controller number.

Multi Volume 0...127

```
Multi Volume  1
              127
```

Multi Volume sets the overall volume for the selected Multi program. It affects all Instruments of the Multi program, so if you would set **Multi Volume** to 0, you won't hear anything.

i **Multi Volume** is used to set several Multi programs to similar output levels, especially in live situations. While recording in a studio, you should set **Multi Volume** to 127 to get the highest possible Signal-to-Noise ratio.

Multi Tempo 40...300

```
[Multi Tempo 120]
```

Multi Tempo sets the global tempo for all instruments in the selected Multi program. It affects all arpeggiators and all LFO that are set to *clocked*. Please read the chapter "The Tempo" on page 124 for further information.

i The **Multi Tempo** parameter is controlled by the **Tempo** dial in the **Amp/FX/Arp.** section, so it doesn't need to have an entry in the **Multi** parameter pages.

Multi Mixer (not available for the microQ lite)



The Multi Mixer offers fast graphical editing of Volume, Panning and Effect Send for all 16 instruments. The 16 horizontal segments represent the 16 available instruments. A small cursor below the corresponding segment indicates the chosen instrument. With the red dial you can switch between Level Mode and VU Mode.

Level Mode

In Level Mode the settings for all 16 instruments can be quickly edited. The left display knob selects the desired parameter. The right display knob changes the value. You can easily compare values for all 16 instruments at the same time. The following parameters are available:

- *Vol* shows the actual volume of the instruments in Multimode. Here the volume can be changed infinitely variable from 0 to 127
- *FX1* shows the FX1 Mix Level of the Multi Instruments. It can be changed infinitely variable from 0 to 127.
- *FX2* shows the FX2 Mix Level of the Multi Instruments. It can be changed infinitely variable from 0 to 127.

VU Mode

The VU Mode graphically shows all incoming Midi signals and current signal volume as a bargraph (like on a signal analyzer.) This allows you to check which instruments are receiving Midi messages. All of the Multimode parameters can be changed while in VU Mode. In addition to the Level Mode parameters, the following parameter is also available:

- *PAN* sets the panorama position infinitely variable from 0 to 127

 The Multi Mixer offers the possibility to mute or unmute instruments during a live performance.

Sound Parameters

Overview of Functions

The Waldorf microQ consists of numerous sound-shaping components. The following overview gives you an idea of how the individual components interact:

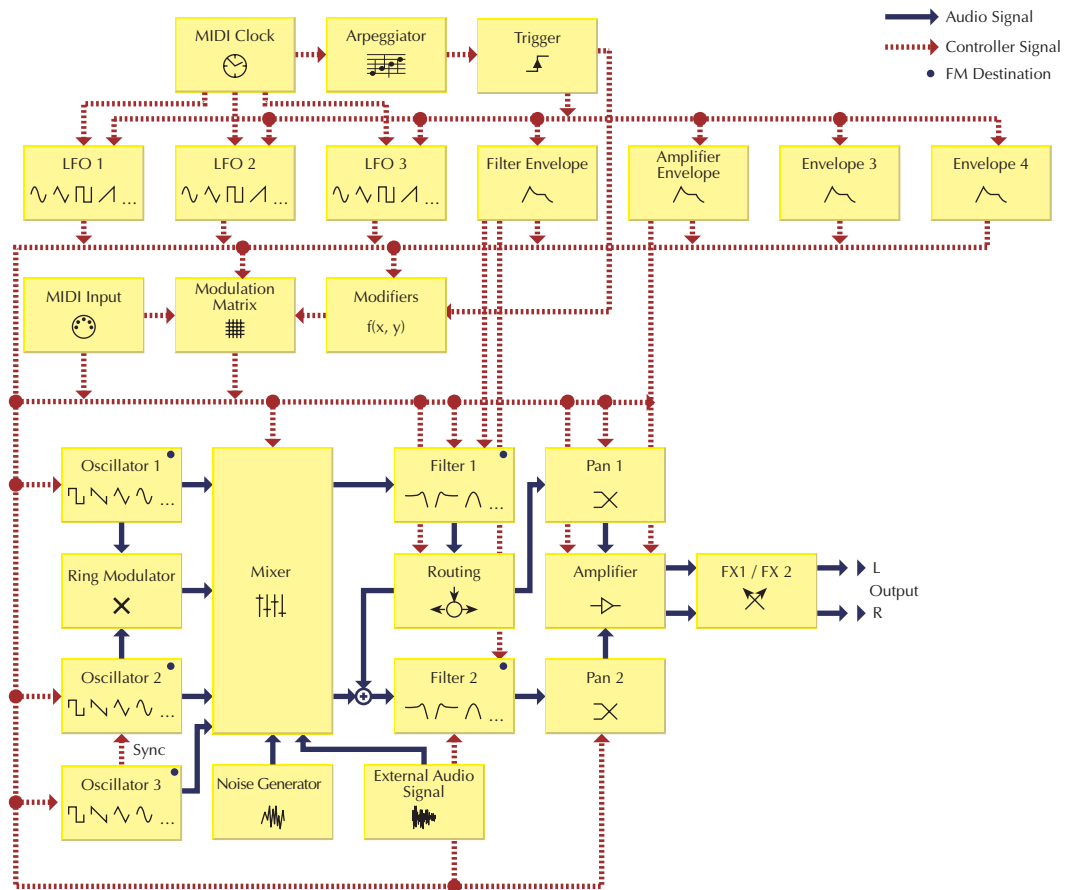

Picture 6: Block schematic diagram of a sound

As you can see, the microQ consists of two different types of components for sound generation and sound shaping:

- Oscillators, Ring Modulator, Noise Generator, External Audio Signal, Mixer, Filters, Amplifier, Effects:
 These modules represent the audio signal flow. Sound generation actually occurs within the Oscillators. They produce square, sawtooth, triangular, sine and alternative waveforms. The Mixer follows the Oscillators in the signal chain, which is where the Oscillators' output signals are mixed. Noise or signals received through the audio inputs can also be added to the mix. The Filter then shapes the sound by amplifying (boosting) or attenuating (dampening) certain frequencies. The Amplifier and the Effects are located at the end of the signal chain. They determine the overall volume of the signal and add some effects like chorus, flanger, delay etc.
- LFOs, Envelopes, Modifiers, Modulation Matrix:
 These modules are called Modulators. The Modulators are designed to manipulate or modulate the sound generating components to add dynamics to sounds. The Low-frequency Oscillators (LFO) are designed for periodic or recurring modulations while Envelopes are for modulations that occur once on each note. These generators are

assigned to parameters through the Modulation Matrix and influence these parameters to alter a sound. In addition, the Modifier unit can process various mathematical operations and functions on the modulation signals.

Modulation Speed Levels

The microQ offers three levels of modulation speeds: FM, Fast Modulation and Standard Modulation. This separation assures maximum flexibility in sound generation while keeping the amount of processor power needed to calculate a voice as low as possible. You will find separate descriptions of how to access the different modulation types in the chapters below. The three modulation speed levels are categorized as follows:

FM (Frequency Modulation)

This is the fastest modulation speed level. These calculations are performed for each generated sample or, in other words, 48000 times per second (48kHz). Five modules of the microQ's sound generation offer FM - the three oscillators and the two filters. When you browse the list of available sources for this type of modulation, you will find almost exclusively those sources that make sense to modulating the destination with sample speed. This includes the oscillators, noise, the LFO, the envelopes and so on. You won't find sources like modwheel or velocity, because their values change incredibly slowly, compared to an oscillator playing at a pitch of i.e. 10kHz. The following table shows all available FM Sources:

FM Sources	Description
Off	No modulation
Osc1	Oscillator 1 Signal
Osc2	Oscillator 2 Signal
Osc3	Oscillator 3 Signal
Noise	Noise Generator Signal
LFO1	LFO 1 Signal
LFO2	LFO 2 Signal
LFO3	LFO 3 Signal
FilterEnv	Filter Envelope Signal
AmpEnv	Amplifier Envelope Signal
Env3	Envelope 3 Signal
Env4	Envelope 4 Signal

Table 3: FM Sources



FM needs a lot of CPU Power which leads to less polyphony.

Fast Modulation

Though not calculated in *sample* speed, the Fast Modulation calculations are performed in *audio* speed: more than 5000 times per second (>5kHz). Most of the modulations in the microQ are performed at this speed level. The following table lists all pre-routed Fast Modulation destinations:

Pre-routed Modulation destinations	Description
Oscillator PitchMod	Global pitch modulation of all three Oscillators at once
Oscillator 1 PWM	Pulse width modulation of Oscillator 1
Oscillator 2 PWM	Pulse width modulation of Oscillator 2
Oscillator 3 PWM	Pulse width modulation of Oscillator 3
Filter 1 CutoffMod	Cutoff modulation of Filter 1
Filter 1 Env	Envelope amount of Filter 1 cutoff
Filter 1 Velo	Envelope velocity amount of Filter 1 cutoff
Filter 1 PanMod	Panning modulation of Filter 1 output
Filter 2 CutoffMod	Cutoff modulation of Filter 2
Filter 2 Env	Envelope amount of Filter 2 cutoff
Filter 2 Velo	Envelope velocity amount of Filter 2 cutoff
Filter 2 PanMod	Panning modulation of Filter 2 output
Amplifier AmpMod	Amplitude modulation
Amplifier Volume	Output shaped by the Amplifier Envelope

Table 4: Pre-routed Modulation destinations

In addition to the pre-routed Fast Modulation destinations, the microQ offers eight slots for individual routing connections that are updated at the same speed level: the Fast Modulation Matrix. The following table lists all available destinations for a Fast Modulation Matrix slot:

Fast Modulation Matrix destinations	Description
Pitch	Global pitch of all three Oscillators at once
O1 Pitch, O2 Pitch, O3 Pitch	Pitch of Oscillator 1...3
O1 PW, O2 PW, O3 PW	Pulse width of Oscillator 1...3
O1 FM, O2 FM, O3 FM	FM Amount modulation of Oscillator 1...3
O1 Level, O2 Level, O3 Level	Mixer level of Oscillator 1...3
O1 Bal., O2 Bal., O3Bal.	Filter 1/2 Balance of Oscillator 1...3
RingLevel	Mixer ring modulation level
Ring Bal.	Filter 1/2 Balance of Oscillator 1
N/E Level	Mixer level of Noise or External signal
N/E Bal.	Filter 1/2 Balance of Noise or External signal
F1 Cutoff, F2 Cutoff	Cutoff of Filter 1...2
F1 Reson., F2 Reson.	Resonance of Filter 1...2
F1 FM, F2 FM	FM Amount modulation of Filter 1...2
F1 Drive, F2 Drive	Drive of Filter 1...2
F1 Pan, F2 Pan	Pan of Filter 1...2
Volume	Amplifier output volume

Table 5: Fast Modulation Matrix destinations

The following table shows all available Fast Modulation sources:

Fast Modulation sources	Description
Off	No modulation
LFO1	LFO 1 Signal
LFO1*MW	LFO 1 Signal shaped by the Modwheel
LFO2	LFO 2 Signal
LFO2*Prs	LFO 2 Signal shaped by Aftertouch
LFO3	LFO 3 Signal
FilterEnv	Filter Envelope Signal
AmpEnv	Amplifier Envelope Signal
Env3	Envelope 3 Signal
Env4	Envelope 4 Signal
Velocity	MIDI Velocity
Modwheel	MIDI modulation wheel (controller #1)
Pitchbend	MIDI pitchbend signal
Pressure	MIDI channel pressure

Table 6: Fast Modulation sources

Standard Modulation

The Standard Modulations are calculated at normal speed, which is still fast enough for the most modulation purposes, e.g. when dealing with the modulation wheel or velocity. The Standard Modulation slots offer an extended set of modulation sources and destinations compared to the Fast Modulation slots. The Standard Modulation speed level is only available in the Modulation Matrix, while all other modulations are performed as Fast Modulations or FM.

Standard Modulation Matrix destinations	Description
Pitch	Global pitch of all three Oscillators at once
O1 Pitch, O2 Pitch, O3 Pitch	Pitch of Oscillator 1...3
O1 PW, O2 PW, O3 PW	Pulse width of Oscillator 1...3
O1 FM, O2 FM, O3 FM	FM Amount modulation of Oscillator 1...3
O1 Level, O2 Level, O3 Level	Mixer level of Oscillator 1...3
O1 Bal., O2 Bal., O3Bal.	Filter 1/2 Balance of Oscillator 1...3
RingLevel	Mixer ring modulation level
Ring Bal.	Filter 1/2 Balance of Oscillator 1
N/E Level	Mixer level of Noise or External signal
N/E Bal.	Filter 1/2 Balance of Noise or External signal
F1 Cutoff, F2 Cutoff	Cutoff of Filter 1...2
F1 Reson., F2 Reson.	Resonance of Filter 1...2
F1 FM, F2 FM	FM Amount modulation of Filter 1...2
F1 Drive, F2 Drive	Drive of Filter 1...2
F1 Pan, F2 Pan	Pan of Filter 1...2
Volume	Amplifier output volume
LFO1Speed, LFO2Speed, LFO3Speed	Speed of LFO 1...3

FE Attack	Attack rate of Filter Envelope
FE Decay	Decay (and Decay 2) rate of Filter Envelope
FE Sustain	Sustain (and Sustain 2) level of Filter Envelope
FE Release	Release rate of Filter Envelope
AE Attack	Attack rate of Amp Envelope
AE Decay	Decay (and Decay 2) rate of Amp Envelope
AE Sustain	Sustain (and Sustain 2) level of Amp Envelope
AE Release	Release rate of Amp Envelope
E3 Attack	Attack rate of Envelope 3
E3 Decay	Decay (and Decay 2) rate of Envelope 3
E3 Sustain	Sustain (and Sustain 2) level of Envelope 3
E3 Release	Release rate of Envelope 3
E4 Attack	Attack rate of Envelope 4
E4 Decay	Decay (and Decay 2) rate of Envelope 4
E4 Sustain	Sustain (and Sustain 2) level of Envelope 4
E4 Release	Release rate of Envelope 4
M1F Amount	Modulation amount of M1F
M2F Amount	Modulation amount of M2F
M1S Amount	Modulation amount of M1S
M2S Amount	Modulation amount of M2S
01SubDiv, 02SubDiv	Frequency divide of the sub oscillator1...2
01SubVol, 02SubVol	Volume of the sub oscillators 1...2

Table 7: Standard Modulation Matrix destinations

The following table shows all available Standard Modulation sources:

Standard Modulation Matrix sources	Description
Off	No modulation
LFO1	LFO 1 Signal
LFO1*MW	LFO 1 Signal shaped by the Modwheel
LFO2	LFO 2 Signal
LFO2*Prs	LFO 2 Signal shaped by Aftertouch
LFO3	LFO 3 Signal
FilterEnv	Filter Envelope Signal
AmpEnv	Amplifier Envelope Signal
Env3	Envelope 3 Signal
Env4	Envelope 4 Signal
Keytrack	MIDI note number
Velocity	MIDI Velocity
Rel. Velo	MIDI note release velocity
Pressure	MIDI channel pressure
Poly Prs.	MIDI polyphonic pressure
Pitchbend	MIDI pitchbend signal
Modwheel	MIDI modulation wheel (controller #1)
Sust. Ctr	MIDI sustain pedal (controller #64)
Foot Ctr	MIDI foot control (controller #4)
BreathCtr	MIDI breath control (controller #2)
Control W, X, Y, Z	assignable MIDI controller W, X, Y, Z

Ctr Delay	Modifier Delay
Modif. #1...#4	Modifier result #1...#4
minimum	constant for minimum modulation (equals 0)
MAXIMUM	constant for maximum modulation (equals +1)
Voice Num	current voice number as mod source
Voice %16, %8, %4, %2	used voice number as mod source
Unisono V	Number of unisono voices
U. Detune	Detuning of all unisono voices
U. De-Pan	De-panning of all unisono voices
U. De-Oct	De-octaving of all unisono voices

Table 8: Standard Modulation Matrix sources

Triggering of Voices

As soon as a note is played, the microQ triggers one or several voices. How this triggering is done is set by the following parameters. You can find these parameters in the Sound Edit menu located in the Master section.

Sound Edit Menu

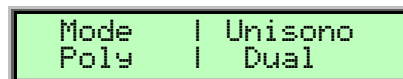

Mode Poly / Mono

Controls if the Sound can be played polyphonically or monophonically.

- *Poly* means that each note triggers its own voice or voices, as on a piano.
- *Mono* means that only the last played note sounds. All other notes are stored in an internal list but aren't played. As soon as you release the note that is currently played, the second last note is played and so on. When you play legato, only the first note that was played triggers the envelopes. All later notes use these envelopes, but sound in the pitch you've played. This mode is for sustained sounds like typical 70's solo sounds.

i When *Mono* is selected and you have set up a decaying volume envelope for the selected Sound, you might not hear anything after playing several notes because of the envelopes decaying to 0.

Unisono Off / Dual / 3...6

Controls how many voices are triggered when a note is played.

- *Off* means that a note triggers one voice. This is the standard mode.
- *Dual* means that a note triggers two voices. Both voices have high priority so they can cut off other voices that are played.
- *3...6* means that this number of voices is triggered when a note is played. Only the first voice has high priority, meaning that it can cut off other played notes. The other voices can only sound if any voices are free or if there are other unison voices with lower priority that could be cut off. This ensures that older notes play at least one voice as long as the voice allocation isn't forced to steal even this voice for a new note.

 Please note that the chosen number of unisono voices will respectively lower the number of available voices.

Unisono Detune 000...031

```
Unisono Detune
012
```

Controls the detuning of the Unison voices. Each voice is detuned differently; with **Unisono Detune**, you control the overall amount.

 **Unisono Detune** is perfectly suited to thickening the tone. Arpeggios benefit too from the detune function.

```
Trig FE ! AE (mono)
Normal ! Single
```

Triggering of the Filter Envelope (Trig FE)

Determines the triggering of the Filter Envelope.

- *Normal* means that every Note starts the filter envelope of its own voice.
- *Single* means that the envelopes of all voices of a selected program behave like a single envelope. This common envelope starts as soon as the first note is played. The sustain level remains until the last note is released. Afterwards the release phase is active.

Triggering of the Amplifier Envelope (AE (Mono))

Determines the triggering of the Amplifier Envelope.

- *Normal* means that every Note starts the amplifier envelope of its own voice.
- *Single* means that the envelopes of all voices of a selected program behave like a single envelope. This common envelope starts as soon as the first note is played. The sustain level remains until the last note is released. Afterwards the release phase is active. This setting is only active as long as the Parameter **Mode** is set to *Mono*. Otherwise the envelope behaves as though set to *Normal*.

```
Trig E3 ! E4 (mono)
Normal ! Single
```

Triggering of the Envelopes 3 (Trig E3) and 4 E4 (mono)

Determines the triggering of the Envelopes 3 and 4.

- *Normal* means that every Note starts the amplifier envelope of its own voice.
- *Single* means that the envelopes of all voices of a selected program behave like a single envelope. This common envelope starts as soon as the first note is played. The sustain level remains until the last note is released. Afterwards the release phase is active. This setting is only active as long as the Parameter **Mode** is set to *Mono* (only Envelope 4). Otherwise the envelope behaves as though set to *Normal*.

Rename Sound

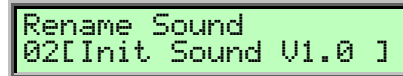

```
Rename Sound
02[Init Sound V1.0 ]
```

This function changes the program's name. Choose the position of the name with the left parameter knob and change the character of the selected position with the right parameter knob. The numbers to the left in the lower row show the currently selected position in the name. You can edit up to 16 characters per name. To save all your changes, please store the sound before leaving this menu.

Oscillators Introduction

The Waldorf microQ is equipped with three oscillators that have almost identical functionality.

Oscillator Shapes

The oscillator is the first building block of a synthesizer. It delivers the signal that is transformed by all other components of the synthesizer. In the early days of electronic synthesis, Robert A. Moog found out that most real acoustic instrument waveforms could be reproduced by using abstracted electronic versions of these waveforms. He wasn't the first who came to that conclusion, but he was the first in recreating them electronically and building them into a machine that could be used commercially. What he implemented into his synthesizer were the still well-known waveforms sawtooth, square and triangle. For sure, this is only a minimal selection of the endless variety of waveforms, but the Waldorf microQ gives you exactly these waveforms at hand, plus other classic waveforms like pulse (which is the father of the square waveform) and the sine wave (also part of every other waveform).

Now, you probably know how these waveforms look and sound, but the following chapter gives you a small introduction into the deeper structure of these waveforms. Let's start with the most basic one.

The Sine Wave

The Sine Wave is the purest tone that can be generated. It consists only of one harmonic, the fundamental, and has no overtones. The following picture shows the sine wave and its frequency representation:

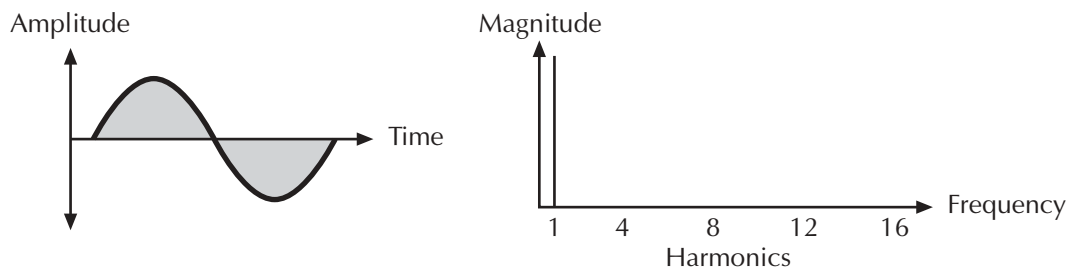

The Sine Wave

There is no acoustic music instrument that generates a pure sine wave; the only instrument that comes close to it is the pitch fork. Therefore, the sine wave sounds a little artificial to the ear. However, the sine wave can be an interesting oscillator waveform to emphasize a certain harmonic while other oscillators are playing more complex waveforms, or as FM source for frequency modulation.

The sine wave is the most basic building block of each waveform. Any waveform can be broken down to several or many sine waves that are arranged with different frequencies and magnitudes. These sine waves are called *partials*. In most waveforms, the partial with the lowest frequency is dominant, meaning that this partial is used by the ear to determine the pitch of the tone. This partial is called *fundamental*. All other partials are called *overtones*. So, the second partial is the first overtone.

Cyclic waveforms such as the waveforms in the microQ only feature sine waves in integer frequency ratios to the fundamental like double frequency, triple frequency and so on. Those partials are called *harmonics* because their frequency is a harmonic multiple of the fundamental.

Confusing? Let's generalize it to cyclic waveforms: a cyclic waveform like sawtooth, square etc. only consists of harmonic partials. The harmonic with the lowest frequency is dominant and therefore called fundamental. All other harmonics are called overtones.

The Sawtooth Wave

The Sawtooth Wave is the most popular synthesizer waveform. It consists of all harmonics in which the magnitude of each harmonic descends by the factor of its position. This means that the first harmonic (the fundamental) has full magnitude, the second harmonic has half magnitude, the third harmonic has a third magnitude and so on. The following picture shows how the individual harmonics build up the sawtooth wave:

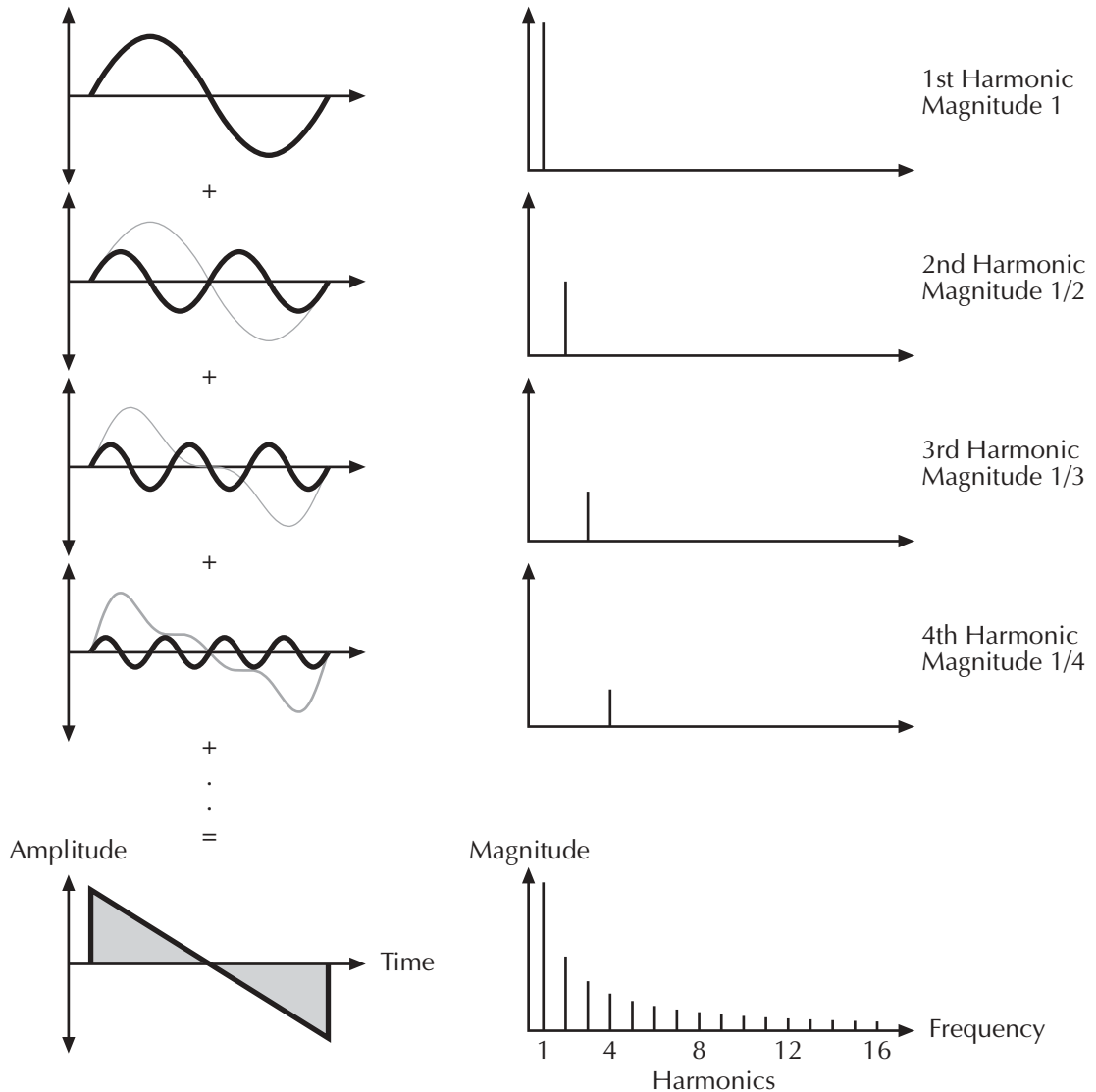

Picture 7: Additive components of the Sawtooth wave

The sawtooth wave was thought as an abstraction of the timbre of string and brass instruments. You can easily understand that when you think of a violin. Imagine a bow pulling the string slightly into one direction. At one point, the string abruptly comes off the bow and swings back to its original position. The bow is still moved and so it catches the string again and the procedure is repeated. The result is a waveform that looks like a sawtooth. The same is true for a brass instrument. The string in this case are the lips while the bow is the air. The lips are moved by the air to a certain extent and abruptly move back to their original position.

The Square Wave

The Square Wave is a special waveform generated by a pulse waveform with 50% pulse width. This means that the positive part of the waveform has equal length to the negative part. The pulse waveform can have other pulse widths as you will read later. For now, we'll talk about the square wave as a unique waveform. The square wave consists of all odd harmonics in which the magnitude of each harmonic descends by the factor of its position. This means that the first harmonic has full magnitude, the third harmonic has a third magnitude, the fifth harmonic has a fifth magnitude and so on. The following picture shows how the individual harmonics build up the sawtooth wave:

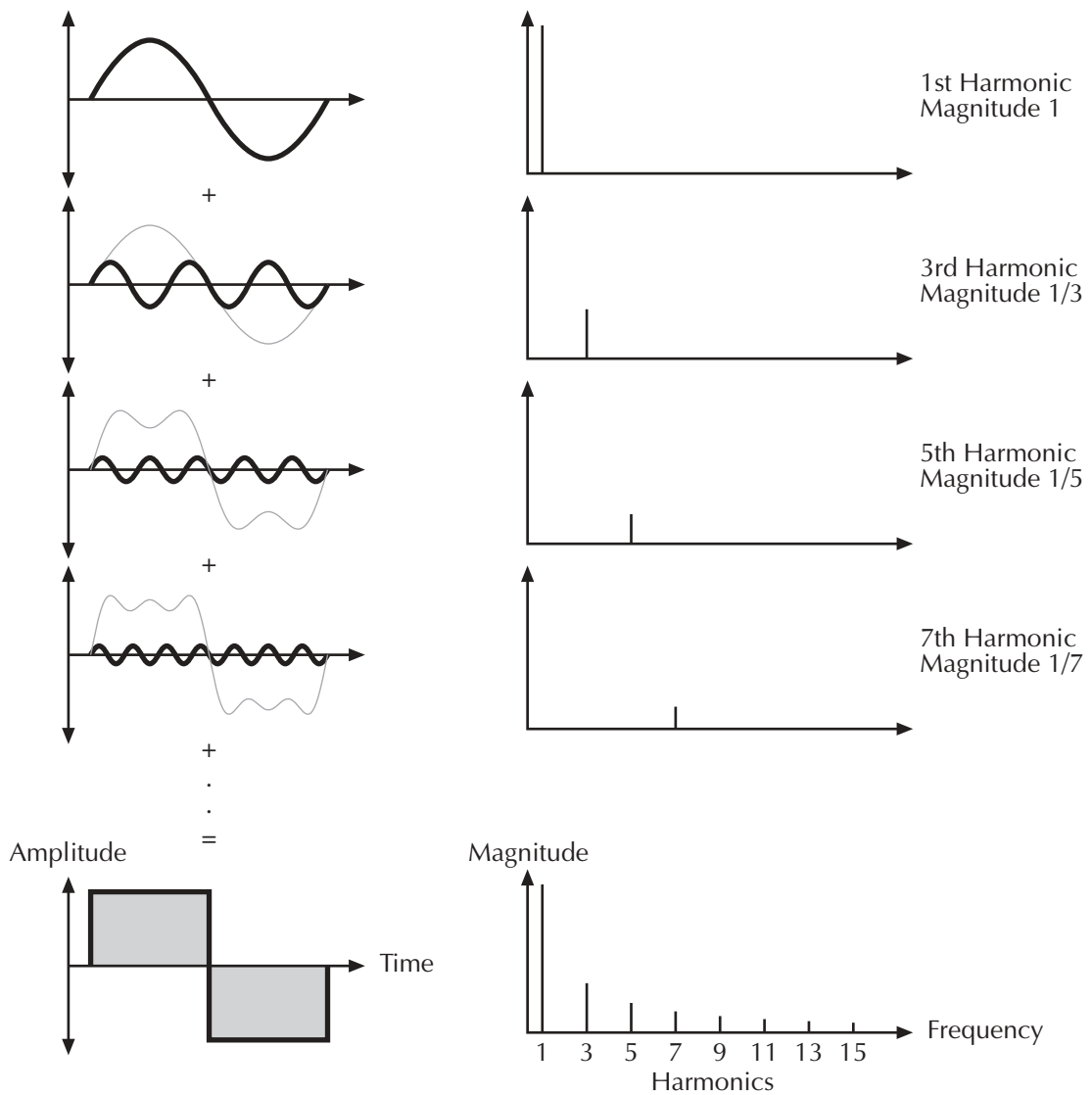

Picture 8: Additive components of the square wave with 50% pulse width

The square wave was thought as an abstraction of wind instruments like a panflute or a recorder. They consist of a tube that can contain a certain amount of air. The player blows air through the tube in a way such that the air starts to vibrate. This vibration is almost completely symmetrical, resulting in a hollow timbre.

The Pulse Wave

The Pulse Wave is the most versatile wave in a classic synthesizer because its shape and therefore its harmonic content can be changed in real time. This is done by changing the width of the upper and lower portion of the waveform cycle. These portions are called pulses, hence the name pulse width. The width of the first pulse is used to distinguish between different pulse waves and it is measured in percent. The following picture shows several pulse waves with different pulse widths:

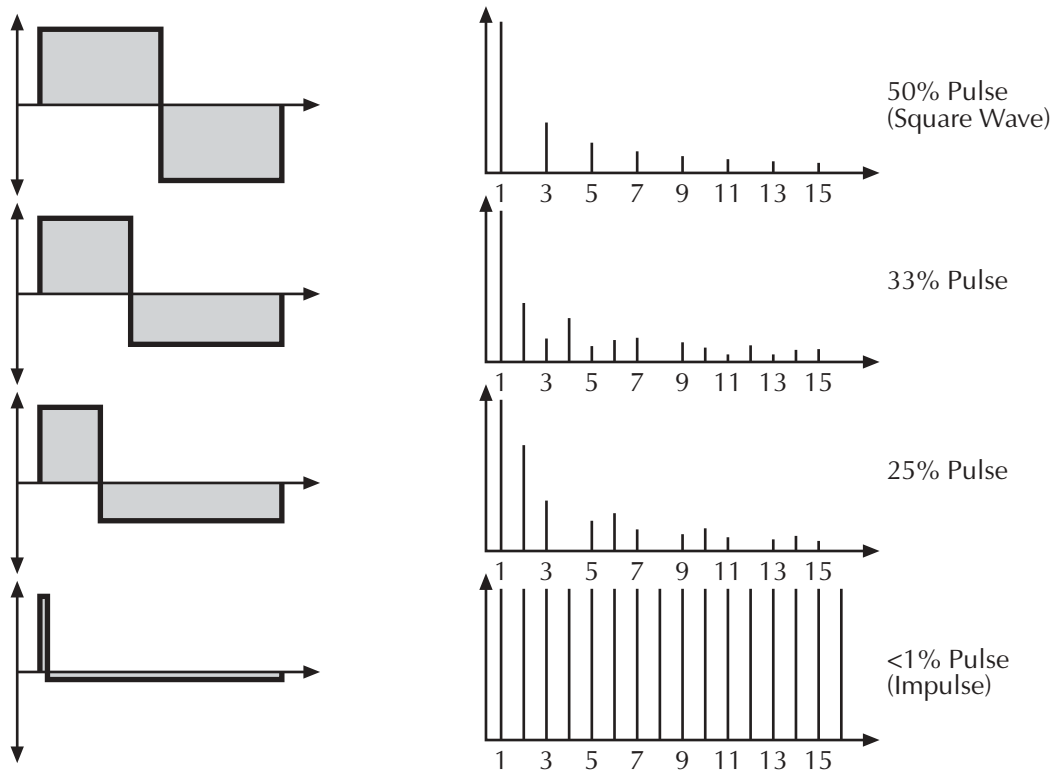

Picture 9: Additive components of Pulse wave with different pulse widths

The first thing you probably observe is that the lower part of the wave has a narrower excursion. This is because the energy of the wider pulse is higher than the one of the narrower pulse. If this were not compensated for in the waveform, the overall signal would have an unwanted DC offset.

As you have read in the previous chapter, the harmonic content of a 50% pulse wave is a special case. It has a very symmetrical harmonic content, while all other pulse widths create peaks or troughs at certain frequencies. Another special case is a pulse wave with a very narrow pulse width, in the above picture labelled as <1%. An infinitely thin pulse creates a spectrum that has all harmonics with equal magnitudes. In a digital synthesizer, “infinitely” necessarily means one sample.

The pulse wave is an artificial wave, which means that it doesn’t occur in nature. It was built into synthesizers because it could create a lot of different timbres with a minimum of technical effort. However, certain pulse widths sound very close to the timbres of acoustic (or semi-acoustic) instruments, i.e. a guitar or bass guitar, an e-piano or even a flute.

The most powerful feature of the pulse wave is the ability change its width while sounding. This is called pulse width modulation. When the pulse width is changed, the waveform starts to sound thicker. This happens because the effect is very similar to what you hear when you have two oscillators running with slightly different frequencies. They interfere and create irregular troughs in the resulting waveforms.

The Triangle Wave

The Triangle Wave is very similar to the square wave. It is composed of the same harmonics as the square wave, but with different magnitude ratios. The magnitude of each harmonic is divided by the power of its number. This means that the third harmonic's magnitude is a ninth, the fifth harmonic is a twenty-fifth and so on. The following illustration shows the harmonic content:

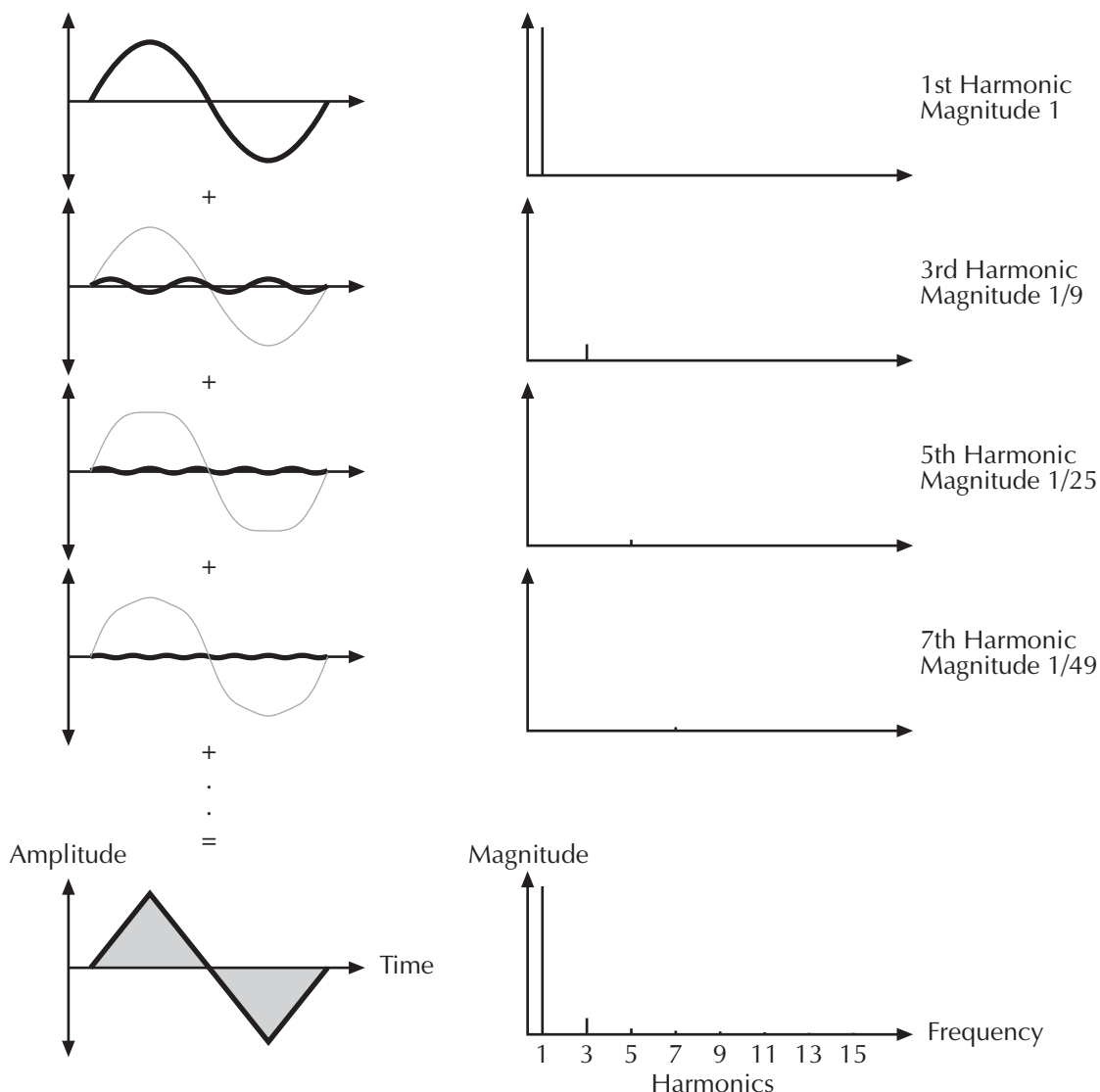

Picture 10: Additive components of the Triangle wave

The reason why the triangle wave is so popular in classic synthesizers is because it was easier to generate than a sine wave but could be used for the same purpose. It could act as a suboscillator wave, to emphasize certain frequencies or to frequency modulate other oscillators.

The triangle wave sounds like a woodwind instrument, i.e. a clarinet. It can also be used for mallet instruments like vibraphone, xylophone etc.

Wavetable Synthesis in the microQ

The sound generation of the alternative waveforms (Alt1 and Alt2) of the microQ is based on wavetable synthesis. This type of synthesis combines analog access and digital flexibility in a simple way. Although wavetable synthesis is a form of "sample playback" in principle, you should avoid this term because functionality, operation and results are totally different. Each of Alt1 and Alt2 contain one wavetable with 128 Waves each.



Please keep the terms "wavetable" and "wave" in mind. Don't confuse the two.

The following overview explains how the Wavetable Synthesis works:

A wavetable into the microQ is a table consisting of 128 waveforms. Each waveform is classified by its own special sound character. The main difference of wavetable synthesis in comparison with other sound generation principles is the facility not only to play one waveform per oscillator, but also to walk through the wavetable via different modulations. Therefore you can create wavetable sweeps. The results can be dramatic - much more so than those any sample playback based system could ever produce. This is a unique feature of wavetable synthesis.

This principle offers powerful capabilities. To give some examples:

- Each note on a keyboard can access a different wave of the wavetable.
- Different waves can be played depending on key velocity.
- A LFO can modulate the position within the wavetable. You can create subtle to drastic sound changes.
- User-selected controllers e.g. the mod wheel, can change the position within the wavetable. When you turn the wheel while playing a chord, each note's wave will be modified instantly.
- Wavetables are perfect as the FM Source when you want to create very strange sounds.

You should keep the following sentence in mind because it describes the essential of the wavetable synthesis:

A wavetable is a table of pointers to up to 128 waves, among which you can move at will.



If you like the sound and possibilities of wavetable synthesis, you should try out the Waldorf Microwave II, XT or XTk. These are pure wavetable synthesizers. Also the Waldorf PPG Wave 2.V as a VST Instrument is capable of this synthesis.

Oscillator Section

The most important controls of the oscillators can be found in the parameter matrix. The following picture shows the microQ's **Oscillators Section**:



Picture 11: Oscillators Section





Selecting an Oscillator

Choose the **Oscillators** section with the navigation buttons, and then the Oscillator you wish to edit. The LED of the corresponding Oscillator will light up. When keeping the left navigation button pressed and pushing the right navigation button at the same time, you can select from one to three available Oscillators at the same time. This allows you to edit two or three Oscillators simultaneously.

Oscillator Parameter Controls



Octave 128'...1/2'

Sets the basic pitch of the oscillator in steps of an octave. The **Octave** setting is shown as register value, a common measurement based on the length of organ pipes. The reference pitch for the oscillator is generated at MIDI note A3 (note no. 69) when **Octave** is set to 8', **Semi** and **Detune** are set to 0, **Keytrack** is set to 100% and no pitch modulation is applied. In this case, the oscillator's frequency will be the same as set in the global **Tune** parameter (usually 440Hz).

-  Set **Octave** to 16' for bass sounds.
-  Set **Octave** to 8' if you are creating typical keyboard sounds.
-  Set **Octave** to 4' if you are programming strings or other high pitched sounds.
-  When you use an Oscillator to modulate other Oscillators or the Filters, experiment with the Octave parameter. Low settings might result in periodic modulations while high settings might add a bell character to the timbre.
-  Ultra-low settings like 128' can create very nice rhythmic changes when used with the ring modulator. If this is still not low enough, you can use the Standard Modulation Matrix to apply MAX to the respective oscillator pitch with a negative amount.



Semi -12...+12

Sets the pitch of the oscillator in semitone steps. The standard setting for this parameter is 0, but there are cases where different values are interesting as well.

-  Organ sounds often include a fifth, therefore one oscillator's semitone parameter must be set to +7.
-  Lead and Solo sounds might sound interesting when you set one Oscillator to e.g. a fourth (+5 semitones).
-  When making ring modulated or FM sounds, try to use dissonant values, e.g. +6 or +8.



Detune -64...+63

Fine-tunes the oscillator in steps of 1/128th of a semitone. The audible result of detuned oscillators is a Chorus or Flanger effect. Use a positive setting for one oscillator and an equivalent negative setting for another.

-  A low value of ± 1 results in a slow and soft Flanger effect.
-  Mid-ranged settings of ± 5 are perfect for pads and other fat sounding programs.
-  High values of ± 12 or above will give a strong detune that can be used for accordions or effect sounds.

FM 0...127

Sets the amount of frequency modulation that is applied to the oscillator by the selected **FM source** in the Oscillators Edit menu. The sound will get more metallic and sometimes even drift out of tune, especially if Oscillator 2 is used as FM Source for Oscillator 3 and **Sync** is activated. To avoid unusable detune, use a triangular or sine waveform for the FM Source.

-  If you want to bias **FM** over the keyboard so that higher notes aren't modulated as strongly as lower notes, use the **Standard Modulation Matrix** and apply *Keytrack* to the respective oscillator FM with a negative amount.
-  To change the amount of **FM** dynamically, use the **Fast Modulation Matrix** or **Standard Modulation Matrix** to apply an *Envelope* or an *LFO* to the respective oscillator FM with positive amount.

 This parameter may also be found in the **Oscillator Edit Menu** for the sake of completeness.

 **FM** requires a lot of CPU Power, which can lead to decrease polyphony.

Shape *Off / Pulse / Saw / Tri / Sine / Alt1 / Alt2*

Sets the type of waveform to be generated by the Oscillator. The parameter is called **Shape** instead of "waveform", because it doesn't necessarily set only one waveform, but sets a specific oscillator model that could produce a number of waveforms depending on other settings. A good example for this behaviour is the *Pulse* shape. However, the term "waveform" is used interchangeably throughout the manual. The following shapes are currently available:

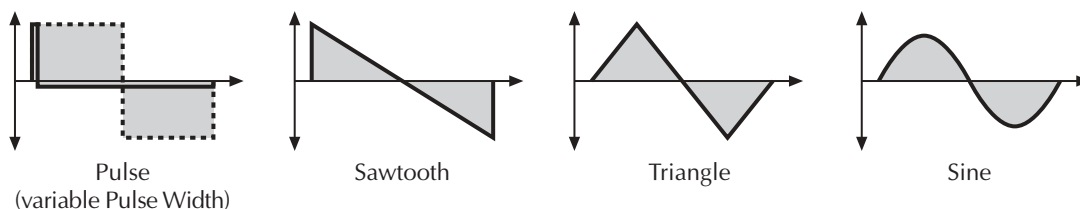

- *Off* disables the selected oscillator for the purpose of increasing Polyphony. Please read the chapter "Dynamic performance management" on page 24.
- *Pulse* selects the pulse waveform. A pulse waveform with a pulse width of 50% has only the odd harmonics of the fundamental frequency present. This waveform produces a hollow / metallic sound. If the Pulse waveform is selected, the parameters **Pulsewidth** and **PWM** are used to change the pulsewidth of the waveform. Furthermore, the modulation

destinations *O1PW*, *O2PW* or *O3PW* gain functionality, depending on which oscillator is set to *Pulse*.

- *Saw* selects the sawtooth waveform. A Sawtooth wave has all the harmonics of the fundamental frequency in descending magnitude. It doesn't have any further parameters. This waveform is pleasing to the ear.
- *Tri* selects the triangular waveform. The triangle mainly consists of the odd harmonics with very low magnitudes. It doesn't have any further parameters.
- The *Sine* waveform consists of the fundamental frequency only. It has no harmonics at all. It doesn't have any further parameters.
- *Alt1* and *Alt2* are wavetable generators. Both can create a wavetable with 128 waves each. Please refer the chapter "Wavetable synthesis". When *Alt1* or *Alt2* are selected, the knobs **Pulsewidth** and **PWM** serve to select the start point of the waves. Furthermore, the modulation sources *O1PW* and *O2PW* are active subject to which Oscillator is set to *Alt*. In the Oscillators Edit Menu you additionally have Suboscillators at your disposal (please read also „Suboscillators“ in the chapter „Oscillators Edit Menu“ on page 67). Please note that the Wavetables are only available for Oscillators 1 and 2.

- ☀ The *Pulse* shape can be used to create unusual synthesizer sounds and oboe like sounds.
- ☀ The *Saw* shape can be used for basses, leads, brass and string sounds.
- ☀ The *Tri* shape can be used for flute sounds or soft pads.
- ☀ The *Sine* shape can be used to produce basses and electric organ sounds.
- ☀ The *Sine* shape is also perfectly suited for ring modulation or as **FM Source**.
- ☀ *Alt1/Alt2* waves are perfect for very vivid sounds.
- ☀ The tips listed here of course are only suggestions. The variety of tones among all Waveforms in the microQ are nearly inexhaustible.



Oscillators should be set to "off" when not using them. This saves DSP Power and therefore can contribute to increased polyphony.

PW - Pulsewidth 0...127

Sets the pulse width of the Pulse waveform. The value 0 is equivalent to a pulse ratio of <1%, the value 127 is equivalent to 50%. You determine the start point of the wavetable at *Alt1* or *Alt2* with the **Pulsewidth** knob, at which 0 selects the first of 128 Waveforms. If you select any waveform other than *Pulse*, *Alt1* or *Alt2*, this parameter does not have any effect. The following picture illustrates the effect of the pulsewidth parameter:

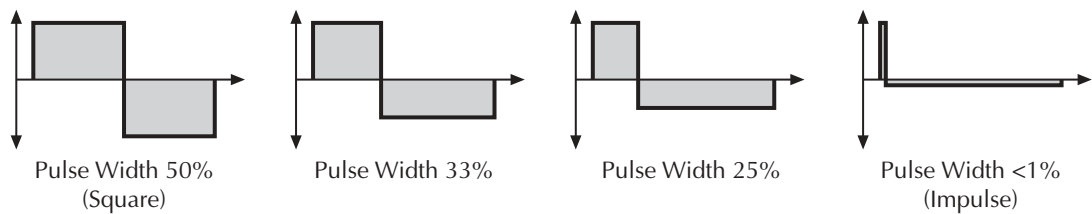

Picture 12: Pulse Width parameter results

- ☀ A pulse width of 50% can be used for flute sounds or very hollow bass sounds.
- ☀ A pulse width of around 30% can be used for e-piano or fat bass sounds.
- ☀ A pulse width of around 10% is interesting for Clavinet sounds.
- ☀ Experiment with different start points for *Alt1*- and *Alt2*-Waveforms to get an overview of the array of available Waveforms for both wavetables.

Alt1 and Alt2 waveforms

At this point we offer a few more hints and tips about the „Alternate Waveforms“:

As stated above, the **Shapes** *Alt1* and *Alt2* each contain a wavetable generator showing a few particulars that are opposite to the normal synthesis functions. Please refer to the chapter "Wavetable Synthesis" on page 58.

To make sure that you have access to the power of the wavetable synthesis, you should make yourself familiar with the sound and the characteristics of both wavetables. The best way to do this is to set up a kind of test sound to listen to the wavetables:

☞ Test program for wavetables

1. Start with an initialized sound program (please read "Init Sound" on page 136).
2. Choose *Alt1* as **Shape** for oscillator 1, and turn down the mixer level of oscillator 2 and 3.
3. Choose the modulation wheel (*Modwheel*) as **PWM-Source** for oscillator 1.
4. Set the **PWM** amount to -63.

Now you can use the Modulation Wheel of your MIDI Master keyboard to sweep through the whole wavetable. Choose *Alt2* to hear how this wavetable sounds. You will notice that both wavetables cover an extremely wide range of interesting spectral timbres, including analog, FM-like, bell-type or vocal.

- ☀ To get very lively sounds you should always use modulators when using the Wavetables of *Alt1* and *Alt2*.
- ☀ When you like to create a wavetable sweep you should set the starting point roughly to the desired position with **Pulsewidth** before programming the modulation. This procedure can help to find the basic character of the sound being affected by the modulation.
- ☀ Please note that you can use unipolar as well as bipolar modulation sources. For instance, set the **Pulsewidth** Parameter to 64, nearly the middle of the wavetable, and use a slow LFO to sweep through the whole wavetable.

- ☀ Try out very lively sounds by using different fast modulation sources (LFOs or envelopes) on Oscillator 1 set to **Alt1** and Oscillator 2 set to **Alt2**, and additionally ring- and frequency-modulating the signal.
- ☀ Please note that additional Suboscillators are available when using **Alt1** and **Alt2** (see the chapter „Suboscillator“).

PWM -64...+63

PWM stands for pulsewidth modulation. This parameter determines the amount of modulation that is applied to the pulsewidth of the oscillator's square wave. If *Alt1* or *Alt2* is selected, **PWM** determines the amount of the wavetable modulation. If you select any shape other than *Pulse*, *Alt1* or *Alt2*, this parameter does not have any effect. The modulation source that affects the pulsewidth is selected by the source parameter described below.

PWM Source see Table "Fast Modulation Sources"

Selects the source of the pulsewidth modulation or the wavetable modulation. Common sources for pulsewidth modulation are envelopes and LFOs, but other sources like the modulation wheel or aftertouch can create nice effects as well.

- ☀ To create a thick oscillator sound, use a triangular *LFO* as **PWM Source** with full **PWM** and a **Pulsewidth** of around 80. This basic setting is useful for very big string and lead sounds. When you play different notes on the keyboard, you might notice that bass notes sound more detuned than higher notes. To avoid this behaviour, set **Keytrack** of the used LFO to a positive setting between 50% and 100%.
- ☀ To create a Bass sound, use a decaying *Envelope* as **PWM Source** with negative **PWM** and a **Pulsewidth** of around 80...127. This results in a fat attack phase, especially when only one oscillator is used for the Bass.
- ☀ When you want to create a sound with a wave sweep, you should set the startpoint roughly (**Pulsewidth**) at the desired wave, before you apply any modulation. This will help you to find the basic waveform, before the effect of modulations. Note that you can apply unipolar and bipolar modulation sources. For example, set **Pulsewidth** to 64, which is almost the middle of the wavetable and apply a slow running LFO to **PWM Source** to sweep through the whole wavetable.

Oscillator Edit Menu

The following parameters can be accessed via the display menu. Press the **Edit** button when you are in the Oscillators section to activate the display menu.

```
01 Keytrk | 01 BendRg
+100% | +12
```

01 Keytrk (Keytrack) -200%...+197%

Determines how much the pitch of the oscillator 1 depends on the MIDI note number. The reference note for Keytrack is E3, note number 64. For positive settings, the oscillator pitch rises on notes above the reference note, for negative settings the oscillator pitch falls by the same amount and vice versa. A setting of +100% corresponds to a 1:1 scale, e.g. when an octave is played on the keyboard the pitch changes for the same amount. Other settings than +100% make sense especially when using ring modulation, FM or oscillator synchronization. Try to use values in the range 0%...+75% or even negative settings for one oscillator while leaving the second at +100% Keytrack.

01 BendRg (Bendrange) -24...+24

Determines the intensity of the pitchbend via MIDI Pitchbend messages in semitones for oscillator 1.

```
01 FM Src | 01 FM Amt
Osc3 | 000
```

01 FM Src (FM Source) see Table "FM Sources"

Selects the source for the frequency modulation of oscillator 1.

 You can create nice E-Piano sounds when you use a high pitched oscillator as **FM Source** and set its **Keytrack** to a value between +000% and +050%.

 The use of Noise is very interesting as **FM Source** on a high pitched oscillator playing a sine or triangle waveform. With low **FM** amount, the oscillator starts to sound dirty or airy while higher amounts create a coloured noise similar to a filter with high resonance. A side benefit is that the filters are then still free for other purposes.

01 FM Amt (FM Amount) 0...127

Please read the "FM" in the chapter "Oscillator Parameter Controls" on page 60.

 **FM** requires a lot of CPU Power, which can lead to decrease polyphony.

02 Keytrk (Keytrack) -200%...+197%

Determines how much the pitch of the oscillator 2 depends on the MIDI note number. For more information please refer to "01 Keytrk".

02 BendRg (Bendrange) -24...+24

Determines the intensity of the pitchbend via MIDI Pitchbend messages in semitones for oscillator 2.

02 FM Src (FM Source) *see Table "FM Sources"*

Selects the source for the frequency modulation of oscillator 2.

02 FM Amt (FM Amount) *0...127*

Please read the "FM" in the chapter "Oscillator Parameter Controls" on page 60.



i FM requires a lot of CPU Power, which can lead to decrease polyphony.

02 Sync *off / on*

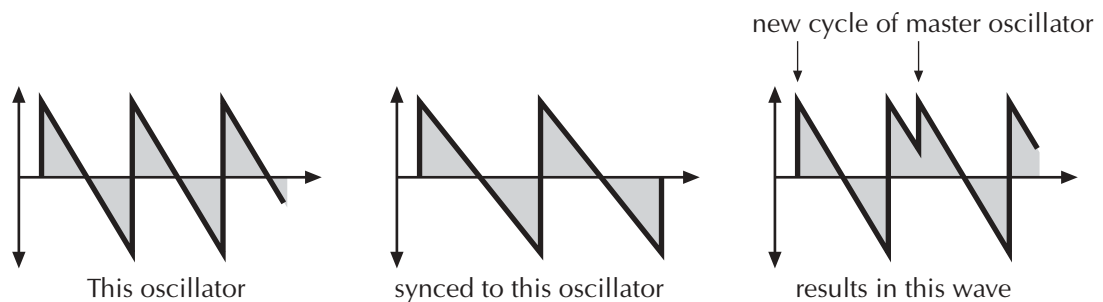
Enables or disables oscillator synchronization. When enabled, Oscillator 2 acts as a slave that is controlled by Oscillator 3, the master. Each time Oscillator 3 starts a new cycle, it sends a trigger signal to Oscillator 2, forcing it to restart its waveform cycle, too. As a result, interesting sound effects may be generated, especially when both oscillators are operating at different pitch settings. Using additional pitch modulation by envelopes, LFO, or Pitch bend will lend further movement to sync sounds. The following picture illustrates the principle of oscillator synchronization in a simplified way:



Picture 13: Oscillator Sync

-  Use **Sync** for Lead or Solo sounds. Set Oscillator 2 to play one octave and 7 semitones higher, apply an envelope to its pitch with positive amount and you get a screaming sync sound.
-  **Sync** can also be very interesting on arpeggio sounds. Apply a slow clocked LFO to Oscillator 2 pitch and the arpeggio starts to move.

03 Keytrk (Keytrack) *-200%...+197%*

Determines how much the pitch of the oscillator 3 depends on the MIDI note number. For more information please refer to "01 Keytrk".

03 BendRg (Bendrange) *-24...+24*

Determines the intensity of the pitchbend via MIDI Pitchbend messages in semitones for oscillator 3.

03 FM Src (FM Source) *see Table "FM Sources"*

Selects the source for the frequency modulation of oscillator 3.

03 FM Amt (FM Amount) *0...127*

Please read the "FM" in the chapter "Oscillator Parameter Controls" on page 60.

i FM requires a lot of CPU Power, which can lead to decrease polyphony.

```
Pitch Src!Pitch Mod
Off | +00
```

Pitch Src (Pitch Source) see Table “Fast Modulation Sources”

Selects the source of the pitch modulation for all oscillators. A common source for pitch modulation is an LFO whose strength is controlled by the modwheel or aftertouch.

☀ To create a common pitch vibrato that is controlled by the modwheel, set **Pitch Source** to *LFO1*MW* with **Pitch Mod** set to around +20.

☀ To create a sound whose pitch glides in, set **Pitch Source** to a decaying *Envelope* with **PitchMod** set to around -25.

i If you want to modulate the pitch of individual oscillators, you can do so with the **Fast Modulation Matrix** or **Standard Modulation Matrix**, which can be accessed through the **Mod Matrix** section. See the respective section for details.

Pitch Mod -64...+63

Sets the amount of pitch modulation for all oscillators. Positive amounts will raise the pitch when positive modulation is applied, e.g. by pressing aftertouch on the keyboard. Negative amounts will lower the pitch when positive modulation is applied.

```
Glide
Off
```

Glide off/on

Enables or disables the Glide effect. "Glide" or "Portamento" describes the continuous gliding from one note to another. This effect can be created on fretless stringed instruments or some brass instruments (e.g. trombone). It is very common on synthesizers and used throughout all music styles. Please note that Glide affects the pitch of all oscillators.

```
GlideMode! Rate
Porta | 064
```

Glide Mode Portamento / Fingered Portamento / Glissando / Fingeres Gliss

Determines the way the Glide effect works.

- *Portamento* means that a continuous glide is performed on all new notes.
- *Fingered Portamento* means that a continuous glide is performed only when notes are played legato. Staccato played notes start on the exact pitch of their note.
- *Glissando* makes the normal Glissando effect in the same manner by changing the pitch in semitones.
- *Fingered Gliss* is similar to Glissando but generates a pitchchange only when notes are played legato.

Rate *0...127*

Determines the glide time. Low values will give a short glide time in a range of milliseconds that gives a special character to the sound. High values will result in a long glide time of up to several seconds which can be useful for solo and effect sounds.

Suboscillator

```
01Sub Vol!Frq.divide
127 1 24
```

The parameters for the Suboscillator settings are only available when *Alt1* or *Alt2* are chosen as Waveform. Therefore Oscillator 3 cannot create a Suboscillator. **SubVol** determines the volume of the Suboscillator creating a Square Waveform. A setting of *0* corresponds to no volume. Please note that the loudness of the Suboscillator also depends on the volume of the main oscillator. **Frq.divide** determines the relative proportion of Sub- and Main oscillator frequencies. Higher values represent a lower tuning.



When Alt-Waveforms are selected for the first two oscillators and the Suboscillators are activated, the microQ can create up to 5 (!) oscillators per voice.

Mixer/Routing Section

In the Mixer, you control the volumes of the oscillators, the noise generator, and an external sound source. Ring modulation can be applied optionally to extend the microQ's tonal range. Routing controls the signal flow of the filters.

The following picture of the microQ's parameter matrix shows the Mixer/Routing section:



Picture 14: Mixer/Routing Section

Mixer/Routing Parameter Controls

The most commonly used controls of the Mixer can be found in the parameter matrix.

Osc 1 / 2 / 3 0...127

Volume of the selected Oscillator(s).

Balance 1 / 2 / 3 F1 64...mid...F2 63

Determines the ratio of the selected Oscillator's signal that is sent to the inputs of Filter 1 and Filter 2. If set to *F1 64*, the signal is sent to Filter 1 only. Higher values will increase the amount of signal that feeds Filter 2 and decrease the amount of signal that feeds Filter 1. If set to *mid*, both filters will receive the same signal level. If set to *F2 63*, the signal is sent to Filter 2 only.

Filter Routing *serial / parallel*

The Routing function is one of the advanced features of the microQ. Its purpose is to control the signal flow of the filters. In comparison with many other synthesizers where signal flow is static, the microQ offers a more flexible configuration.

The microQ offers two independent filters and panning units. In fact, the panning units are part of the filters in the microQ. The routing control makes it possible to change the signal flow from a parallel to a serial filter configuration and vice versa. Furthermore, the routing control is modulatable via the modulation matrix.

This is how the Routing section works in detail:

- The Mixer/Routing section uses two separate outputs – one connected to the input of Filter 1, the other connected to the input of Filter 2. Each sound source, i.e. the oscillators, the ring modulator, and the noise generator/external input has an individual **Balance** control in the Mixer. By means of these controls you can determine what portion of each source's signal is routed to the inputs of Filter 1 and Filter 2. E.g. this makes it possible to send the signal of Oscillator 1 and 2 to Filter 1 and the ring modulation signal to Filter 2.
- The output of Filter 1 is split up into two paths. The **Routing** knob determines the ratio of the signals for each path.
- When the **Routing** parameter is set to *serial*, the whole output signal of Filter 1 is routed to the input of Filter 2, and added to the amount of signal that is already coming from the Mixer through its dedicated output. This setting is equivalent to a serial connection of the two filters.

- When the **Routing** parameter is set to *parallel*, the whole output signal of Filter 1 is routed to the filter’s panning unit. This setting is equivalent to a parallel routing of two filters, each filtering the input signals independently.
- After passing the panning units, both signals are summed up again and sent to the Amplifier and FX sections.

Mixer/Routing Edit Menu

The following parameters can be accessed via the Mixer/Routing Edit menu. If you are in the Mixer/Routing section press the **Edit** button to activate this display menu.

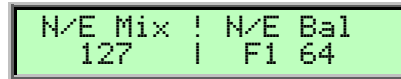

N/E Mix – Noise/External Mix / Ext. 0...127

Volume of the noise generator respectively the external sound source connected to the stereo **External In** jack. This control behaves differently depending on the setting of **N/E Select F1/2 feed** in the Mixer Edit menu. Noise is a fundamental source for any kind of analog-type percussion. Also, wind and other sound effects can be created by using the noise generator.

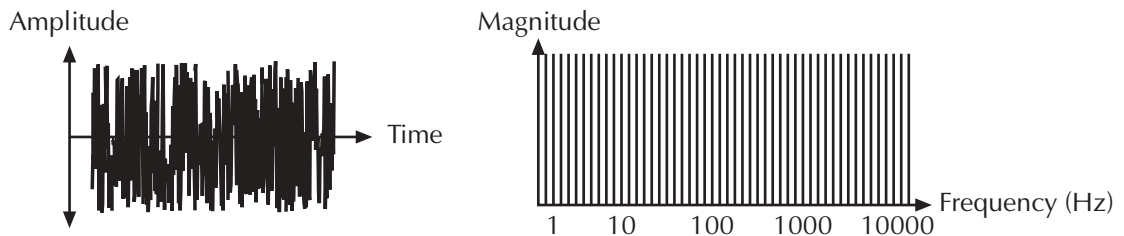

Picture 15: Noise



Please note that if you use an external sound source, you still have to trigger the microQ’s envelopes to get the signal passed through. So you have to generate MIDI notes from a connected sequencer or the internal arpeggiator to hear the audio signal.

N/E Bal - Noise / Ext. Balance F1 64...mid...F2 64

Determines how loud the signals set up in **N/E Select F1/F2 feed** are sent to the inputs of Filter 1 and Filter 2. **Noise / Ext. Balance** behaves differently from the other Balance controls. It doesn’t move the signal between Filter 1 and Filter 2 but controls the loudness ratio between the two signals set up in **N/E Select F1/F2 feed**. The signal set up in **F1 feed** is always sent to Filter 1 while the signal set up in **F2 feed** is always sent to Filter 2.



N/E Select F1 / F2 Feed Noise / ExtLeft / ExtRight / ExtL+R

Sets the input signal sources that are fed into filter 1 and filter 2.

Please note that the **N/E Balance** control behaves differently compared with the other Balance controls. **N/E Balance** only affects the input levels but doesn't shift the signals between the filters. **F1 Feed** is always routed to Filter 1 while **F2 Feed** is always routed to Filter 2.

The available sources are:

- *Noise* selects the Noise Generator as input for the respective filter.
- *ExtLeft* selects the Left input signal as input for the respective filter.
- *ExtRight* selects the right input signal as input for the respective filter.
- *ExtL+R* feeds the summed signal of the left and right input into the respective filter.



Noise needs CPU Power which results in decreased polyphony. If you don't need the noise generator set **N/E Select F1/F2 feed** not to *Noise*.

```
Ringmod !Ring Bal
000 ! F1 64
```

RingMod - Ringmodulation 0...127

Volume of the ring modulation between Oscillator 1 and 2. From a technical point of view ring modulation is the multiplication of two oscillators' signals. The result of this operation is a waveform that contains the sums and the differences of the source frequency components. Since the ring modulation generates disharmonic components, it can be used to add metallic distorted sound characteristics. This is useful e.g. when generating synth percussion. Please note that in a complex waveform all harmonic components behave like interacting sine waves, resulting in a wide spectral range of the ring modulated sound. The following pictures show the results of a saw wave ringmodulated with a square wave and two ringmodulated sine waves:

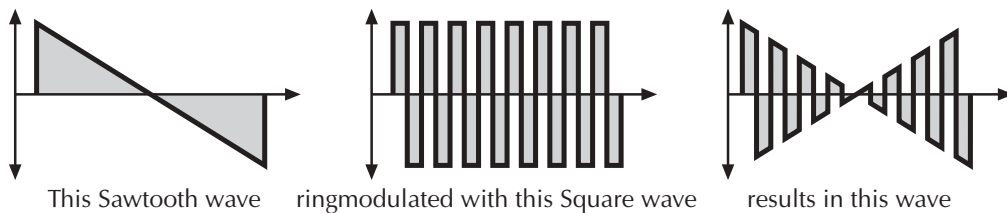

Picture 16: Ring Modulation of a Sawtooth and a Square wave with different frequencies.

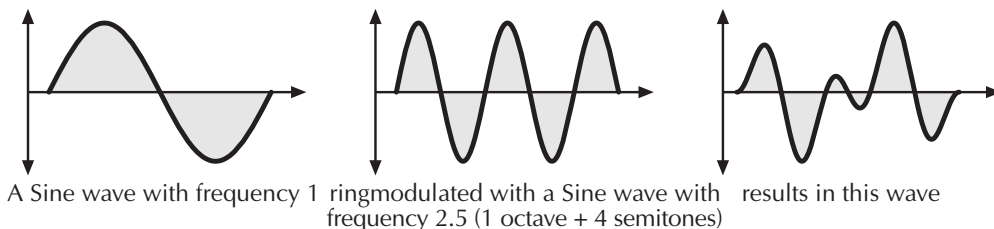

Picture 17: Ring Modulation of two Sine waves with different frequencies.



Ring Modulation can result in unwanted low frequencies when the pitches of oscillator 1 and 2 don't differ very much. This is logical because when you use i.e. one oscillator set to 100Hz and the second set to 101Hz, the resulting ring modulation is 201Hz and 1Hz, and 1Hz is very low.



Ring Modulation can be very interesting when a slow pitch modulation is applied to one oscillator, i.e. a decaying *Envelope*. This creates spacy effect sounds.



For an E-Piano sound, you might apply Ring Modulation when one high pitched oscillator's **Keytrack** is lowered to i.e. 50%.



If you turn down the pitch of one oscillator markedly, you can get an effect very similar to Amplitude modulation. Use this for sounds with a periodic element if you wish.

RingMod Balance *F1 64...mid...F2 63*

Determines the ratio of the ring modulator's signal that is sent to the inputs of Filter 1 and/or Filter 2. If set to *F1 64*, the signal is sent to Filter 1 only. Higher values will increase the amount of signal that feeds Filter 2 and decrease the amount of signal that feeds Filter 1. If set to *mid*, both filters will receive the same signal level. If set to *F2 63*, the signal is sent to Filter 2 only.

Filter Introduction

Once the audio signal leaves the mixer, it is sent to the filters. The microQ has two independent filter units, each with its own individual settings. The signal flow in the filters can be controlled via the Routing function. The filters are components that have significant influence on the microQ's sound characteristics.

For a detailed description of the different filter types that are available in the microQ, see the section "Filter Types" on page 78. For now, we'll explain the basic function of a filter discussing the type used most commonly in synthesizers: the low pass filter.

The low pass filter type dampens frequencies that lie above a specified cutoff frequency. Frequencies below this threshold are hardly affected. The frequency below the cutoff point is called the pass band range, the frequencies above are called the stop band range. The microQ's filter dampens frequencies in the stop band with a certain slope. The slope can be 12dB or 24dB per octave. This means that the level of a frequency that lies an octave above the cutoff point will be 12dB or 24dB less than those frequencies of the signal that fall into the pass band. The following picture shows the basic principle of a low pass filter:

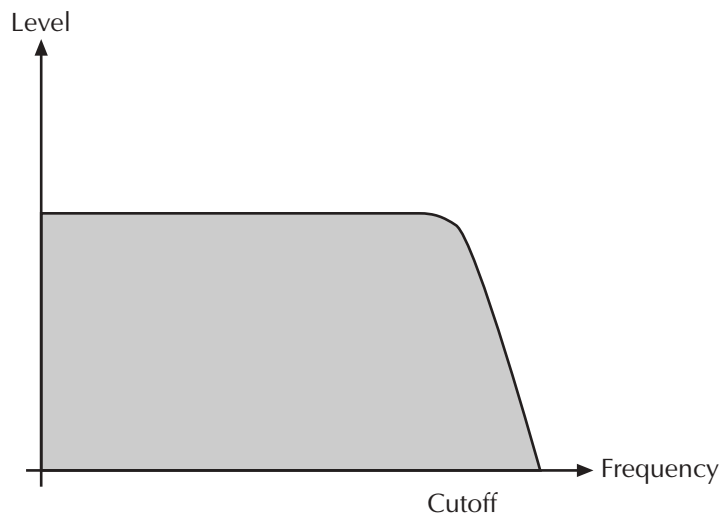

Picture 18: Low Pass Filter principle

To give you an idea of the extent of damping, consider this example of a low pass filter: A reduction of 24dB reduces the original level one octave above the cutoff point by approx. 94%. The damping factor two octaves above the cutoff point reduces the original level by more than 99%, which in most cases means this portion of the signal is no longer audible.

The microQ's filter also features a resonance parameter. Resonance in the context of a low, band or high pass filter means that a narrow frequency band around the cutoff point is emphasized. The following picture shows the effect of the resonance parameter on the filter's frequency curve:

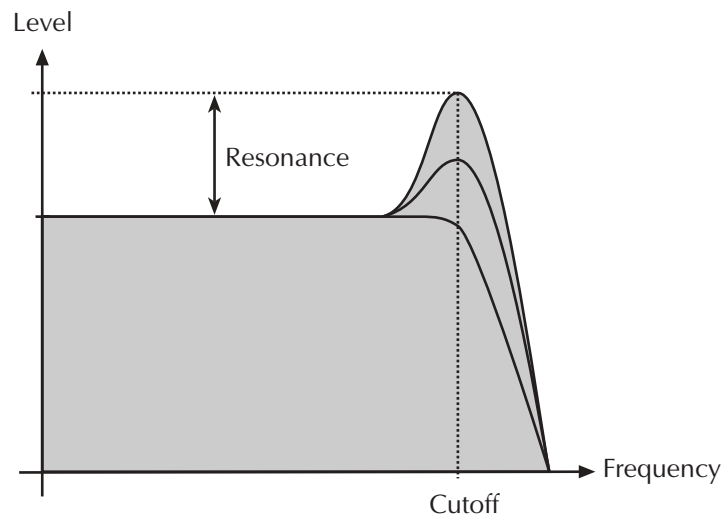

Picture 19: Low Pass Filter Resonance

If the resonance is raised to a great extent, then the filter will begin self-oscillation, i.e. the filter generates an audible sine wave even when it does not receive an incoming signal.

Filter Section

The most commonly used controls of the filters can be found in the parameter matrix.

The following picture of the microQ's parameter matrix shows the Filter section:



Filter section

Selecting and Editing Filters

Before you make any edits to the filters, you must select for editing either Filter 1, Filter 2, or both. This can be done by pressing the left or right navigation button when the Filter section is selected. Push the buttons until both Filter LED light up. The two LED of the Filter section indicate which filter is selected for editing.

If both filters are selected for editing, moving any control will alter the setting of the corresponding parameter for Filter 1 and Filter 2. Please note that all edits are relative. Therefore, the relationship of the parameters will be retained. E.g. the display may look like this when turning the **Cutoff** knob:

```
[F1 Cutoff 80]
[F2 Cutoff 93]
```

In the given example, turning the **Cutoff** control two steps clockwise will result in the following:

```
[F1 Cutoff 82]
[F2 Cutoff 95]
```

If the value range of one parameter is reached, e.g. by turning **Cutoff** clockwise until 127 is set for Filter 1, the relationship is no longer retained. In this case, the cutoff of Filter 1 will keep its maximum value while Filter 2's cutoff is still increased by turning the knob.



The scenario is different when you move the **Type** knob. If both filters are selected for editing and **Type** is altered, the same filter type is assigned to Filter 1 and Filter 2. This takes place because altering selection parameters relatively does not make any sense.

Filter Parameter Controls

Cutoff *0...127*

Controls the cutoff frequency for the low pass and high pass filter types, the center frequency for the band pass and notch filter types, and the delay length of the comb filter types.

- When a low pass is selected via the **Type** parameter, all frequencies above the cutoff frequency are damped.
- When a high pass type is selected, all frequencies below the cutoff frequency are damped.
- When a band pass type is selected, only frequencies near the cutoff setting will be passed through.
- When a notch type is selected, the frequencies near the cutoff frequency are damped.
- When a comb type is selected, the frequencies near the cutoff frequency are emphasized (comb+) or attenuated (comb-).

You can bring more movement into the sound by modulating the cutoff frequency via the LFOs, the envelopes or the *Keytrack* parameter of the filter. At a value of 64 and a **Resonance** value of 114, the filter oscillates with 440Hz, which is equal to A3 (the Comb+ type oscillates one octave higher). Tuning is scaled in semitone steps. When *Keytrack* is set to +100%, the filter can be played in a tempered scale.

Keytrack -200%...+197%

Determines how much the cutoff frequency depends on the MIDI note number. The reference note for *Keytrack* is E3, note number 64. For positive settings, the cutoff frequency rises on notes above the reference note, for negative settings the cutoff frequency falls by the same amount, and vice versa. A setting of +100% corresponds to a 1:1 scale, so e.g. when an octave is played on a keyboard the cutoff frequency changes by the same amount. If you want to play the filter in a tempered scale, e.g. for a solo sound with self-oscillation, set the value to +100%. On most bass sounds lower settings in the range +50...+75% are optimal to keep the sound smooth at higher notes.

Resonance 0...127

Controls the emphasis of the frequencies around the cutoff point. Use lower values in the range of 0...80 to give more brilliance to the sound. At higher values of 80...113 the sound gets the typical filter character with a strong boost around the cutoff frequency. When the setting is raised to values above 113, the filter starts to self-oscillate, generating a pure sine wave. This feature can be used to create analog-style effects and percussion-like electronic toms, kicks, zaps etc.

Drive 0...127

Determines the amount of saturation that is added to the signal. If set to 0, no saturation will be added or, in other words, the signal will remain clean. Lower values will add some harmonics to the signal, resulting in a warm character. Increasing the value will bring in more and more distortion, suitable for harder lead sounds and effects.

Env (Filter Envelope Amount) -64...+63

Determines the amount of influence the filter envelope has on the cutoff frequency. For positive settings, the filter cutoff frequency is increased by the modulation of the envelope, for negative settings, the cutoff frequency is decreased. Use this parameter to change the timbre of the sound over time. Sounds with a hard attack usually have a positive envelope amount that makes the start phase bright and then closes the filter to get a darker sustain phase. String sounds, on the other hand, usually use a negative envelope amount that gives a slow and dark attack before the cutoff rises in the sustain phase.

Velocity (Filter Velocity) -64...+63

Determines the amount of influence the filter envelope has on the cutoff frequency, based on key velocity. This parameter works similarly to the **Env** parameter with the difference that its intensity is velocity based. Use this feature to give a more expressive character to the sound. When you hit the keys smoothly, only minimal modulation is applied. When you hit them harder, the modulation amount also gets stronger. The following picture illustrates the functionality of this parameter:

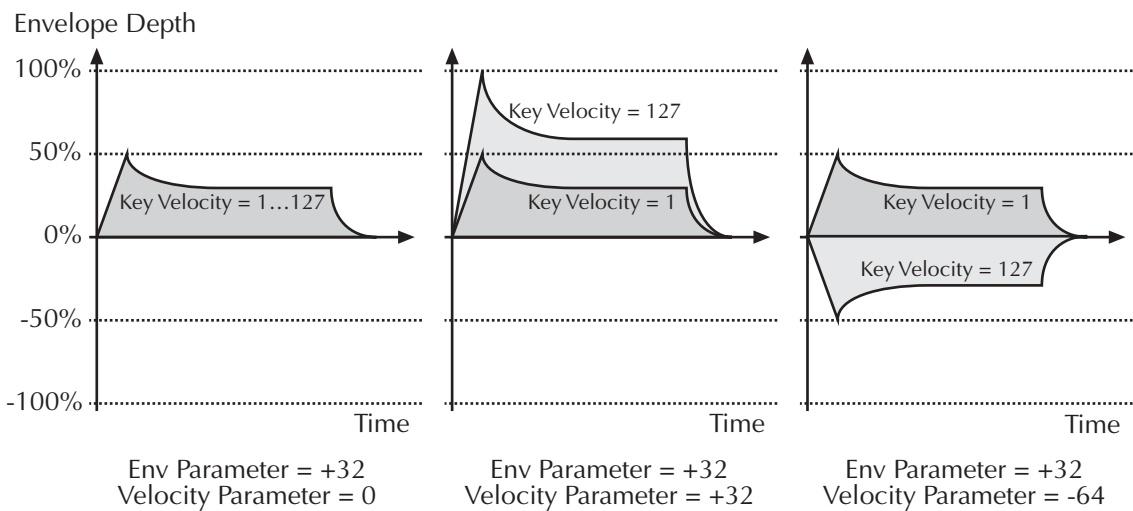

Picture 20: Envelope depth influence of different Velo parameter settings

i The overall modulation applied to the filter’s cutoff frequency is calculated as the sum of both the **Env** and **Velocity** parameters. Therefore you should always bear this total in mind, especially when the filter does not behave as you expect. You can also create interesting effects by setting one parameter to a positive and the other to a negative amount.

Type *see chapter “Filter Types”*

Selects the filter type. Further information on the different filter types is given at the end of this chapter.

i Usage of Filters (especially comb filters) requires DSP Power, and therefore can reduce the available polyphony. A filter switched to “*Bypass*” doesn’t need any DSP Power at all.

Panning *left 64...center...right 63*

Determines the position in the stereo panorama. When the setting is *left 64*, the sound is panned far left; when the setting is *right 63*, it is panned far right. If you want to situate the sound in the middle of the stereo panorama, use the *center* setting. To give further movement to the sound, set this parameter to a basic value and apply some modulation to it via the **PanMod** parameter in the Filter Edit menu.

Filter Edit Menu

The following parameters can be accessed via the Filter Edit menu. If you are in the Filter section press the **Edit** button to activate this display menu.



F1 ModSrc – Filter 1 Cutoff Mod Source *see Table “Fast Modulation Sources”*

Selects the source of the cutoff modulation for Filter 1.

F1 Mod – Filter 1 Cutoff Modulation *-64...+63*

Controls the amount of cutoff modulation for Filter 1. Positive amounts will increase the cutoff frequency when positive modulation is applied, e.g. by pressing the aftertouch on the keyboard. Negative amounts will decrease the cutoff frequency when positive modulation is applied.

```
F1 FM Src!F1 FM Amt
Off | Off
```

F1 FM Src – Filter 1 FM Source *see Table “FM Sources”*

Selects the source of the frequency modulation for Filter 1.

F1 FM Amt – Filter 1 FM Amount *Off, 0...127*

Sets the amount of frequency modulation that is applied to the filter by the selected source for Filter 1.

i FM needs a lot of CPU power, which results in decreased polyphony.

```
F1 PanSrc!F1 PanMod
Off | +00
```

F1 PanSrc – Filter 1 Panning Source *see Table “Fast Modulation Sources”*

Selects the source of the panorama modulation for Filter 1.

F1 PanMod – Filter 1 Panning Modulation *-64...+63*

Determines the amount of panorama modulation for Filter 1.

```
F2 ModSrc! F2 Mod
LF01 | +00
```

F2 ModSrc – Filter 2 Cutoff Mod Source *see Table “Fast Modulation Sources”*

Selects the source of the cutoff modulation for Filter 2.

F2 Mod – Filter 2 Cutoff Modulation *-64...+63*

Controls the amount of cutoff modulation for Filter 2. Positive amounts will increase the cutoff frequency when positive modulation is applied, e.g. by pressing the aftertouch on the keyboard. Negative amounts will decrease the cutoff frequency when positive modulation is applied.

```
F2 FM Src!F2 FM Amt
Off | Off
```

F2 FM Src – Filter 2 FM Source *see Table “FM Sources”*

Selects the source of the frequency modulation for Filter 2.

F2 FM Amt – Filter 2 FM Amount *Off, 0...127*

Sets the amount of frequency modulation that is applied to the filter by the selected source for Filter 2.

i FM needs a lot of CPU power, which results in decreased polyphony.

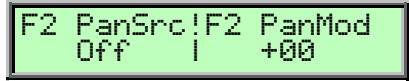

F2 PanSrc – Filter 2 Panning Source *see Table “Fast Modulation Sources”*

Selects the source of the panorama modulation for Filter 2.

F2 PanMod – Filter 2 Panning Modulation *-64...+63*

Determines the amount of panorama modulation for Filter 1.

Filter Types

This paragraph describes the microQ’s different filter types. Most types are based on traditional low pass, high pass or band pass structures.

Bypass

Use this setting to bypass the filter. This is useful if you want to disable the filter temporarily and listen to the oscillators’ pure signals.

i With this setting the microQ doesn’t need any DSP Power for this operation. If you do not want to use Filter 1 or Filter 2 then switch them to “Bypass”.

24dB Low Pass and 12dB Low Pass

The low pass types 24dB LP and 12dB LP are suitable for most normal applications. Use the 24dB slope if you want to create sounds with a typical audible filtered character; use the 12dB slope if you want to get softer results.

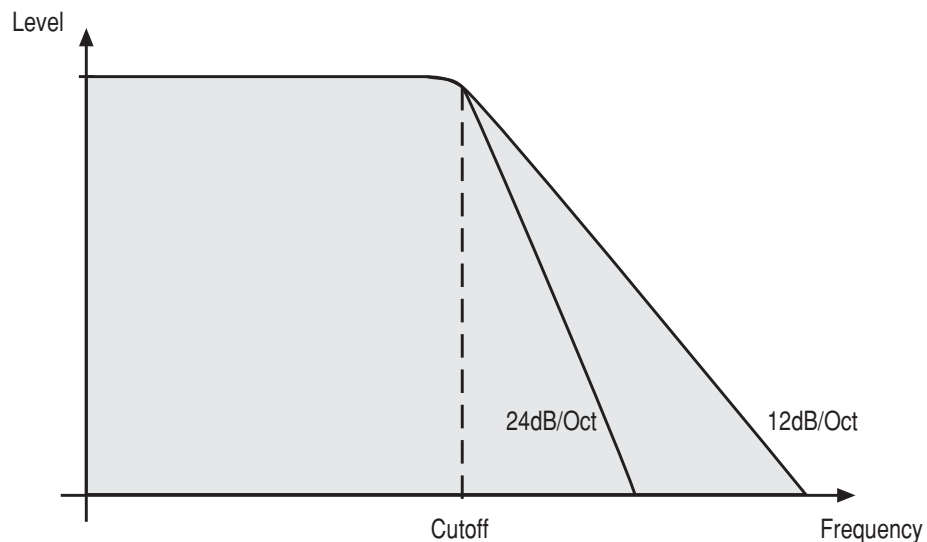

Picture 21: Low Pass Filter Type

24dB Band Pass and 12dB Band Pass

The band pass filters *24dB BP* and *12dB BP* remove frequencies both below and above the cutoff point. As a result, the sound character gets thinner. Use these filter types when programming effect and percussion-like sounds.

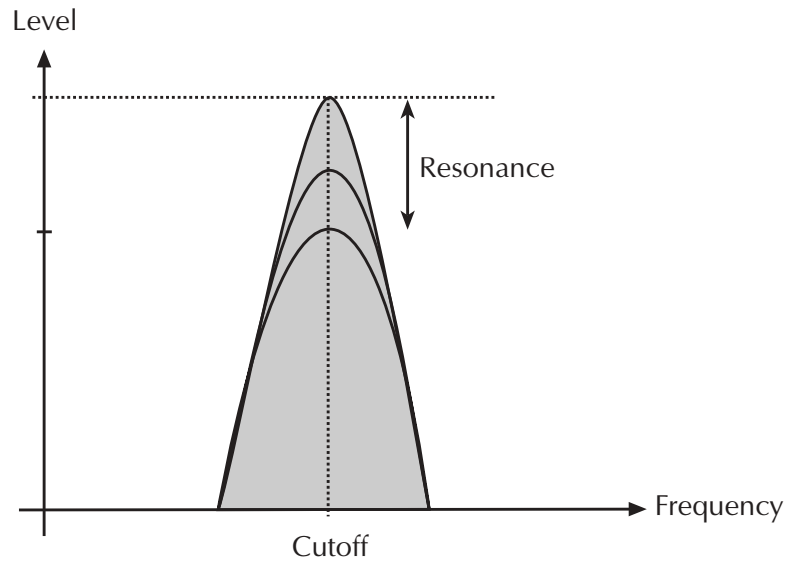

Picture 22: Band Pass Filter Type

24dB High Pass and 12dB High Pass

The high pass filters *24dB HP* and *12dB HP* are useful to thin out a sound's bass frequencies. This may also give interesting results in conjunction with cutoff frequency modulation. By doing this you can e.g. "fly-in" a sound starting at its high harmonics and then coming up to its full frequency range. Use the 24dB slope if you want to create sounds with a typical audible filtered character; use the 12dB slope if you want to get softer results.

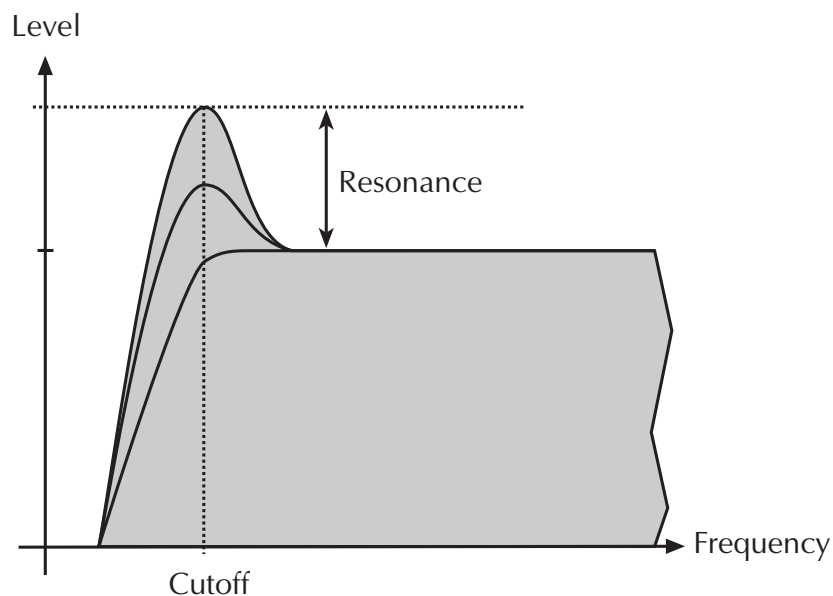

Picture 23: High Pass Filter Type

24dB Notch and 12dB Notch

The notch filters 24dB Notch and 12dB Notch are the opposites of the band pass types. They dampen frequencies around the cutoff point. Frequencies below or above the cutoff point are passed through. Use these filter types for programming effect sounds.

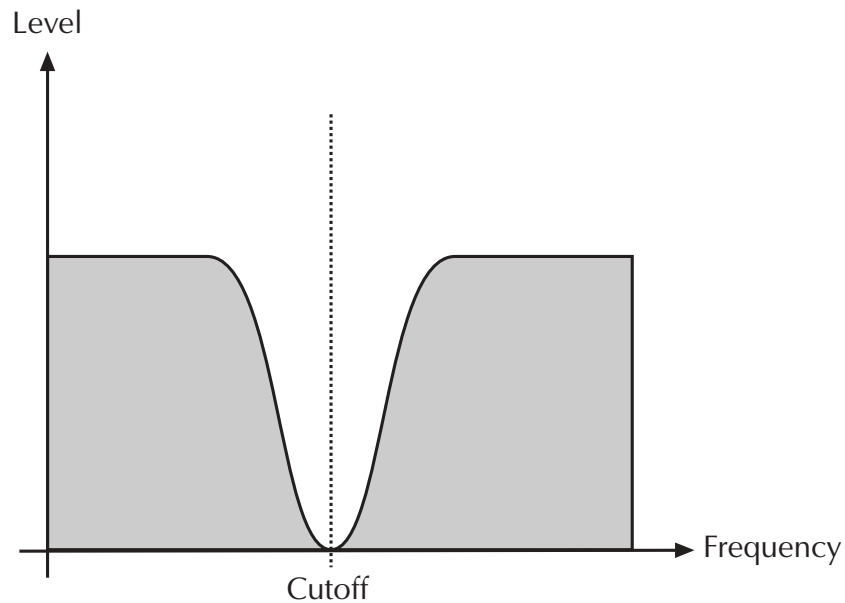

Picture 24: Notch Filter Type

On Notch filter types, the Resonance parameter is almost useless by definition because the resonance frequency is exactly the frequency that is blocked by the filter. However, you will still be able to hear slight differences when you change the Resonance because of phase changes. Anyway, the effect isn't that spectacular.

Comb+ and Comb-

The Comb filter types differ from the other filter types greatly, because they don't actually damp any part of the signal, but instead add a delayed version of the input signal to the output. What exactly is a Comb filter?

A Comb filter is basically a very short delay that can be controlled in length and feedback. The delay time is so short that you can't hear its individual taps but a colorization of the original signal created by peaks or holes in the frequency spectrum. The frequency of the colorization is set by the delay length, which is controlled in the microQ through **Cutoff**, while the amount of colorization is set by the Comb filter feedback, which is controlled in the microQ through **Resonance**.

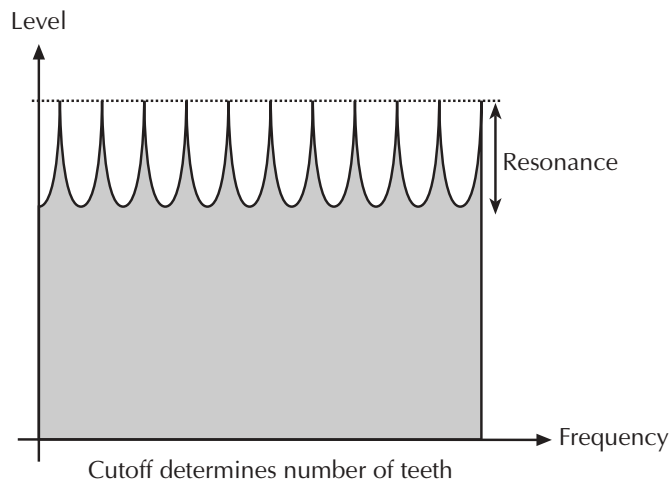

Picture 25: Comb + Filter Type

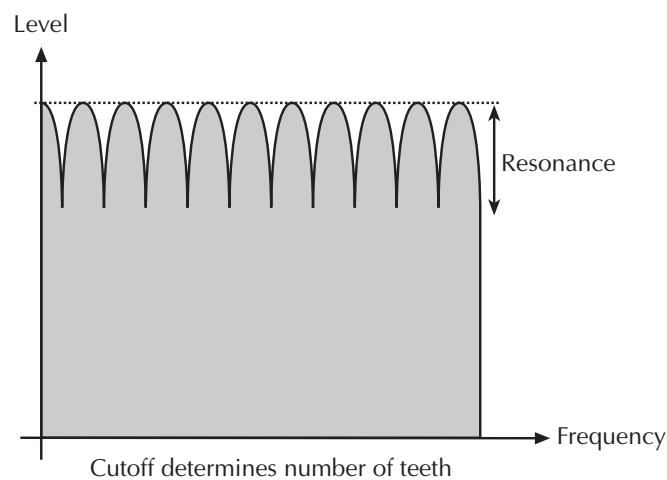

Picture 26: Comb – Filter Type

So, as with all other filter types, the Comb filter is controlled with two parameters:

- **Cutoff** controls the delay length.
- **Resonance** controls the feedback depth.

Now, what sound can a comb filter produce? Here are some examples:

The Comb filter as a Chorus

This is the most basic way to use the Comb filter. A Chorus in fact is made of one or several Comb filters, so this is an easy task to set up manually.

 **To set up the Comb filter to produce a Chorus:**

1. Select the Comb+ filter type for the desired filter.
2. Set **Cutoff** to a medium value.
3. Set **Resonance**, **Drive**, Filter **Keytrack** and any other modulation to 0.
4. Select an *LFO* as **Mod Source**.
5. Set **Mod** to a medium positive or negative amount.
6. Adjust the **LFO** to generate a slow triangle oscillation.
7. Fine tune **Cutoff**, **Mod** and **LFO Speed** until you get the desired Chorus effect.

 You can also use both filters to create a Chorus and pan them to different stereo positions.

 You can also pan the original, i.e. low pass filtered signal, to one stereo side and route 50% into Filter 2, producing a Chorus effect that is panned to the other stereo side.

You might ask why you should use a Comb filter type to produce Chorus instead of using the FX section of the microQ. Here are some reasons:

- The FX sections remain free for other purposes. Also, in Multi Mode, the Comb filter works no matter on which Instrument you use it.
- The Comb filter works *per voice* rather than per Instrument. This means that each voice has its own Chorus and therefore could generate a different Chorus effect. You can easily hear this when you change **LFO Keytrack** or **Filter Keytrack**. Now, each voice sounds with a different Chorus speed or frequency.
- You have full control over MIDI of all parameters that make up the Chorus effect, by using Control messages.

The Comb filter as a Flanger

A Flanger is almost the same as a Chorus. The only difference is that it has feedback circuitry to change the depth of the Flanger effect.

 **To set up the Comb filter to produce a Flanger:**

1. Adjust the filter as described in the Chorus paragraph above.
2. Turn up **Resonance** to create the typical Flanger sound.
3. Gradually lower **LFO Speed** to create slow Flanger sweeps.
4. Select either *Comb+* or *Comb-* to change the character of the Flanger.

 Set up **Mod Source** to *Modwheel* to change the Flanger effect manually.

 Use the **Filter Envelope** with positive or negative amount to create a “one time sweep” that is triggered at Note On.

 Use **Filter Keytrack** with an amount of 100% to create really different flangings depending on the Note you play.

The Comb filter used to simulate a string or a tube

The Comb filter is one of the most basic building blocks of “Physical Modeling”, which is the term for an algorithmic description of an acoustic instrument. The microQ is definitely not meant to replace a good physical modeling synthesizer, so you shouldn’t expect to get a perfect emulation of an acoustic instrument like a trumpet or a violin out of the microQ. However, the Comb filter enables you to create abstractions of those sounds that can be played expressively.

To do so, you have to understand that the Comb filter is the part that actually sets the pitch of the resulting sound; the oscillators or the noise generator are only used to trigger the Comb filter somehow. When you play with the Comb filter, you can hear that it emphasizes or attenuates certain frequencies depending on the setting of Cutoff and Resonance.

When you set **Resonance** to a very high value, you will notice that the Comb filter oscillates heavily, and that’s the key to using it as a tone generator. When you set **Filter Keytrack** to *+100%*, you can play the Comb filter musically.

Now you need to know how to set up Cutoff. Filter Cutoff is scaled in semitone steps, and you only have to find the Cutoff value where the filter oscillates with standard pitch. The following table gives you these settings:

Oscillator	Comb+	Comb-
64'	11	23
32'	23	35
16'	35	47
8'	47	59
4'	59	71
2'	71	83

Table 9: Comb Filter Cutoff settings

If you need other tunings, just keep in mind that **Cutoff** is changed in semitones, so if you increment **Cutoff** by 12, the filter oscillates one octave higher, and so forth.

To set up the Comb filter to produce a tone:

1. Select either *Comb+* to produce a string-like tone or *Comb-* to produce a tube-like tone.
2. Turn up **Resonance** to around 114 to 127.
3. Turn up Filter **Keytrack** to *+100%* to have Filter Cutoff change with equal-tempered scaling.
4. Set **Cutoff** to 23, 35, 47 or 59 to have it oscillating in the same pitch as the oscillator’s usually tuning. Please note that *Comb+* oscillates one octave higher than *Comb-*.
5. Feed the Comb filter with a signal of any kind. The incoming signal’s pitch isn’t important for the resulting tuning, but both pitch and timbre of the input signal affect the timbre of the Comb filter output sound greatly.

 Try to experiment with all kinds of input signals, i.e. different oscillator settings, noise, combinations of both and the like.

 Also try to set up envelopes to control the levels of the input signal, i.e., use a short percussive signal that only triggers the comb filter briefly. The filter then oscillates to produce the resulting tone.

Amp/FX/Arp Section

This section is the last of the microQ’s signal routing. Its purpose is to set the volume of the sound and contains the effect settings. Furthermore this section controls the arpeggiator.

The following picture of the microQ’s Parameter Matrix shows the Amp/FX/Arp section:



Picture 27: Amp/FX/Arp section

Amplifier Parameter Controls

To understand the operation of this unit, it is important to know that the Amplifier Envelope is always acting as a modulation source for the volume. This means that an audio signal can only pass through if the Amplifier Envelope is triggered and opened.

Volume 0...127

Determines the master volume of the sound program.

Velocity -64...+63

Specifies how much volume will be affected by keyboard velocity. Use this feature to give more expression to the sound. With a setting of 0, velocity will have no effect on the volume. Classic organs work in this way because they do not have dynamic response. For positive settings, the volume rises with higher velocities. This is the most commonly used setting, which gives a piano-like character. With negative settings, the volume decreases at higher velocities. This gives an atypical character suitable for effect sounds. As the Amplifier always works in conjunction with the Amplifier Envelope, this parameter actually determines the envelope velocity amount. The following picture illustrates this functionality:

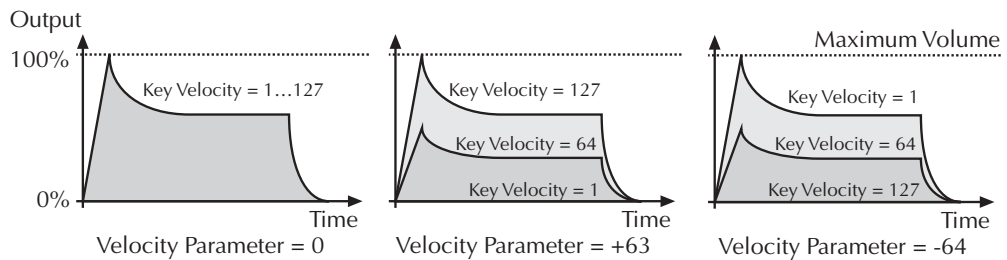

Picture 28: Volume influence of different Velo parameter settings

Amplifier Pages in the Amp/FX/Arp Edit Menu

The following parameter of the Amplifier can be accessed via the Amp/FX/Arp menu only. If you are in the Amp/FX/Arp section, press the **Edit** button to activate this display menu and select the corresponding parameter page.

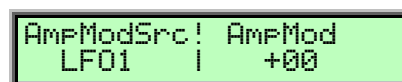

AmpMod Source see Table “Fast Modulation Sources”

Selects the source of the volume modulation.

Effects

The microQ has two effect units. The first effect unit is always part of the Sound Program. The second effect can be assigned either globally or to Instruments 1 through 4. To use the effect units in Multimode please read the chapter “Multi Mode” on page 38.

Effect Parameter Controls

The Effect Parameter Controls can be directly accessed via the Amp/FX/Arp section.

FX 1 Mix 0...127

The only parameter that is common to all types of effects is the **Mix** parameter. This parameter controls the volume ratio between the original signal and the effect output. If set to 0, the dry signal is sent to the outputs only so that no effects can be heard. Higher values will increase the effect signal. At maximum setting, the pure effect signal will be heard.

FX 2 Mix 0...127

See **FX 1 Mix**.

 The usage of effects requires DSP Power and can lead to decreased polyphony. The setting “Bypass” doesn’t need any processing power.

Effect Parameter of the Amp/FX/Arp Edit Menu

Most parameters related to the Effects section are located in the Amp/FX/Arp Edit menu. If you are in the Amp/FX/Arp section press the **Edit** button and turn the **Page Dial** to access these parameters.

 If you hold the **Shift** button while moving the left or right display parameter dial the selected effect gets initialized. This function is useful to get a first impression of the corresponding effect.

FX1 Type *Bypass / Chorus / Flanger / Phaser / Overdrive / Five FX / Vocoder*

```
FX1 (I1) ! FX1 mix
Chorus  ! 056
```

Sets the type of effect produced by the first effect unit. All further parameters depend on the selected effect type.

FX2 Type *Bypass / Chorus / Flanger / Phaser / Overdrive / Five FX / Vocoder / Delay / Reverb / 5.1 Delay / 5.1 D.Clk*

```
FX2 (g1b)! FX2 mix
Delay  ! 036
```

Sets the type of effect produced by the second effect unit. All further parameters depend on the selected effect type.

 The Reverb and Delay FX are only available for the FX2 unit. Reverb, 5.1 Delay and 5.1 D.Clk are not available for the microQ lite.

i The assignment of the second effect processor is done with the **FX2 (glb) link** parameter in the Global Menu. Please also see the chapter “Global Menu” on page 130.

On the following pages all effect types will be described, together with their available settings.

Bypass

Disables the effect unit. No further parameters available.

Chorus

A Chorus effect is generated by using Comb filters that generate slightly detuned copies of the input signal and mix it into the output signal. The result sounds like an ensemble of several simultaneous sounds, like a choir as opposed to a single voice; hence the name Chorus. The detuning is generated by an internal LFO that can be controlled in speed and depth. The Chorus’ high frequency output can be dampened with the Cutoff parameter.

i A Mix setting of 48 to 96 produces the strongest effect because both the unaffected signal and the processed signal are mixed together.

```
Speed | Depth
064 | 064
```

Speed *0...127*

Sets the LFO speed of the Chorus effect.

Depth *0...127*

Sets the modulation depth of the Chorus effect.

```
Delay
064
```

Delay *0...127*

Sets the initial delay that is added to the Chorus delay line.

Flanger

The Flanger effect is very similar to the Chorus effect, but features feedback circuitry to feed the generated signal back into the comb filter. This generates a deeper detuning and colorizes the signal. With extreme settings you can hear a whistling sound which is very characteristic of a Flanger effect.

i A Mix setting of 48 to 96 produces the strongest effect because both the unaffected signal and the processed signal are mixed together.

```
Speed | Depth
064 | 064
```

Speed *0...127*

Sets the LFO speed of the Flanger effect.

Depth *0...127*

Sets the modulation depth of the Flanger effect.

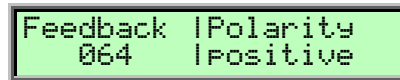

Feedback *0...127*

Controls the feedback amount of the Flanger signal.

Polarity *positive / negative*

Determines whether the feedback signal is fed back into the Flanger as is, or is inverted beforehand.

Phaser

A Phaser is a combination of several "allpass" filters working in parallel. This generates an effect with equally spaced frequency peaks or troughs. The result is a strongly colored signal with a "spacy" character.

i A Mix setting of 48 to 96 produces the strongest effect because both the unaffected signal and the processed signal are mixed together.

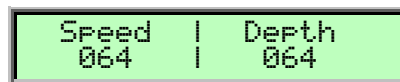

Speed *0...127*

Sets the LFO speed of the Phaser effect.

Depth *0...127*

Sets the modulation depth of the Phaser effect.

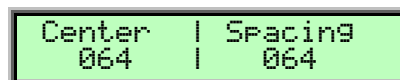

Center *0...127*

Controls the basic delay length of the allpass filters. Lower settings produce a high pitched Phaser effect while higher settings enable the Phaser to cover deeper frequencies.

Spacing *0...127*

Controls the relative frequencies of the allpass filters. A setting of 0 produces a classic phaser, while higher settings spread out the frequencies of the allpass filters.

Feedback *0...127*

Controls the feedback amount of the delay signal.

Polarity *positive / negative*

Determines whether the feedback signal is fed back into the Phaser as is, or is inverted beforehand.

Overdrive

The Overdrive effect distorts the input signal by amplifying it drastically and clipping the resulting signal to a certain output level. The difference between this Overdrive effect and the Drive parameter of the Filter sections is that Drive affects one single voice, while this effect type distorts the summed output of the whole instrument. Therefore, the resulting effect is different as soon as you play more than one note and you should consider which is best suited to a particular sound program. The Overdrive effect, for example, works great on Organ or E-Piano sounds.



Drive *0...127*

Controls the amount of distortion the effect produces. Low values create no or only slight distortion while high values create heavier distortion.

Post Gain *0...127*

Controls the output level of the distorted signal.

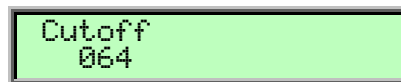

Cutoff *0...127*

Dampens the high frequency output of the Overdrive effect.

i Please note that the setting of the **Mix** parameter doesn't affect the strength of the overdrive effect but only the volume of it. Therefore, you can get a very strong overdrive with a low volume when you turn up **Drive** and turn down **Mix**.

Five FX

This effect type is a combination of five different effects. You can easily use this as a replacement for one of the above mentioned effect types. The quality of Five FX is the same as if you use a single effect, only its parameter set is reduced. The effects and their order is as follows:

- Sample & Hold is a sample rate reduction effect.
- Overdrive is the same as the above described effect.
- Ring Mod allows ring modulation of the effect input signal with another signal.
- Chor/Dlay is a combination of a Chorus and a Delay effect.

i You should turn the Mix control fully up with this effect type because you probably want the sample rate reduction to process the whole signal. The Ring Mod and the Chor/Dlay effect have their own mix control.

Sample & Hold
44.1kHz

Sample & Hold 44.1kHz...2.6Hz

Controls the output sample rate. 44.1kHz means that the signal is unaffected, while other values reduce the sample rate of the sound to the respective rate. You will hear a lot of aliasing when you lower the sample rate, but this is great for so-called “lo-fi” sounds.

Overdrive
064

Overdrive 0...127

Controls the amount of distortion of the signal. Please note that the signal might become a little louder when you increase this parameter.

Ring Mod | Source
064 | Aux

Ring Mod 0...127

Controls the level ratio of the input signal of ring modulation and a second signal that can be chosen with **Source**.

Source External/Aux/Inst.1 FX/Inst.2 FX/Inst.3 FX/Inst.4 FX/Main in/Sub1 in/Sub2 in

Selects the source of the second signal that is used for the ring modulation. The first signal is the summed output of the current Sound or Instrument. You can find more details about the function of a ring modulator in the sub chapter “Ring Modulator” in the chapter “Mixer Edit Menu” on page 70.

- *External* means that the source is the audio signal that comes from the External In jack ❶.
- *Aux* means that the source is the audio signal that comes from the internal Aux bus. Please refer to the chapter "Multimode" on page 40.
- *Inst.1 FX...Inst.4 FX* means that the source is the audio signal that comes from the internal FX bus. Please refer to the chapter "Multimode" on page 40.
- *Main in* means that the source is the summed audio signal that is routed to the microQ’s **Main Out** jack ❷.
- *Sub1 In* means that the source is the summed audio signal that is routed to the microQ’s **Sub Out 1** jack ❸.
- *Sub2 In* means that the source is the summed audio signal that is routed to the microQ’s **Sub Out 2** jack ❹.

Chor/Dlay | Speed
064 | 032

Chor/Dlay 0...127

Controls the mix level of the Chorus/Delay effect.

Speed *0...127*

Controls the LFO speed of the Chorus effect.

```

Depth | Delay
064   | 064

```

Depth *0...127*

Controls the modulation depth of the Chorus effect.

Delay *0...127*

Controls the initial delay that is added to the Chorus delay line.

 Five FX is perfect for processing external audio signals. So start by experimenting with Voice, Speech and Drumloops.

Delay

 This effect type is only available for the **FX2** unit.

A Delay is an effect that produces echoes of the input signal. To make this effect musically useful in a synthesizer, the parameters to adjust the delay length are scaled in note values when **Clocked** is activated. The Delay effect features its own Tempo control but can also synced to the Global Tempo if you like.

The Delay effect is fully stereophonic, meaning that a signal that is routed to the left stereo position is fed into the left or right delay line, and vice versa, depending on the setting of **Auto Pan**.

An important feature of the microQ's Delay effect is that the Delay length can be changed without clicks or pitch changes. This allows you to experiment with different Delay lengths without getting annoying side effects in the output signal.

Clocked *off / on*

```

Clocked
Off

```

If **Clocked** is set to *on*, the delay length is adjusted in note values. If it set to *off*, the delay length is adjusted in milliseconds.

```

Length
001.4ms

```

```

Length | Tempo
8/4.   | internal

```

Length *1.4ms...1.48s 1/128...8/4.*

Sets the length of the Delay tap in milliseconds or note values depending on the **Clocked** setting. A "t" behind the number means a triplet note value while a "." behind it means a dotted note.

i If the adjusted length is longer than the maximum length of the Delay effect, the Delay length is halved automatically.

Tempo *internal / 42...300*

Sets the tempo in BPM (Beats per minute) that is used as basis for the delay length. This parameter only appears if **Clocked** is set to *on*. When set to *internal*, the Tempo is synced to the Global Tempo which in turn is generated by the microQ itself or evaluated from incoming MIDI Clock. See the chapter “The Tempo” on page 124 for details.



Feedback *0...127*

Controls the amount of signal that is routed back into the Delay line. Lower values therefore produce fewer echoes than higher values.

Polarity *positive / negative*

Determines whether the feedback signal is fed back into the delay line as is, or is inverted beforehand.



Cutoff *0...127*

Dampens the signal produced by the Delay effect. This filter is routed before the feedback circuitry meaning that adjacent taps of the Delay will be dampened further. This creates the typical “high frequency loss” that often happens in natural echoes. A setting of 127 means that the signal isn’t filtered, while lower settings filter the high frequencies of the feedback signal.

Auto Pan *Off / On*

Controls an automatic panning effect produced by the delay. If Auto Pan is set to Off, the left input signal is routed into the left delay line and its output signal is fed back into the same delay line. The same is true for the right signal and the right delay line. If Auto Pan is set to On, the left input signal is fed into the right delay line and the right signal is fed into the left delay line. The output of each delay lines is fed back into the opposite delay line. The result is called a Ping-Pong delay.

i You can only hear this effect if the left input signal is different from the right input signal.

Vocoder



The Vocoder effect is a special effect type. Only *one* Vocoder is allowed at a time. When you have several sounds using a Vocoder, the one in the lowest Instrument slot wins. E.g., if you have a sound with a Vocoder effect set up for Instrument 1 and another sound with a Vocoder in Instrument 3, only the Vocoder in Instrument 1 works.

A Vocoder is a circuit to process the frequency content of one signal with the frequency content of another signal. This is done by splitting up the analysis signal (also known as Speech signal) with bandpass filters into several frequency bands. The volume of each frequency band is then evaluated with an envelope follower, and the resulting envelope is used to control the volume of a bandpass filter that processes the synthesis signal (also known as Carrier signal). The synthesis signal is therefore filtered by as many bandpass filters as the analysis signal, so that each analysis filter finds its synthesis filter counterpart.

This technique was developed as early as World War II, but the plan then was to use it to encrypt speech when transmitted by radio, rather than using it to create musically useful sounds. However, this shouldn't disturb you and you should feed a Vocoder with speech, drum loops or any other collection of external audio material you like. The results will always be complex and interesting, sometimes close to the original signal and sometimes much altered. Experiment and have fun.

For the Vocoder, you always need two signals, a signal that is analyzed and another signal that is used for processing by the synthesis filters. The analyzed signal always comes from a different source, either the external input or one of the internal routing busses. The synthesis signal is the current sound, but if you wish to use a different synthesis signal, set up the **N/E Select** parameter in the Mixer/Routing Edit menu to feed the filters with the External In or one of the internal routing busses. It might even be interesting if both the analysis and synthesis signal come from the same source, especially when you set the synthesis band offsets to other values than $+00$. Then a low analysis band might deliver the envelope for a high synthesis band and vice versa.

To preserve the original signal as much as possible, the synthesis signal should only consist of a simple, unfiltered noise that you generate with the microQ's noise generator. For a spoken or sung voice, you should add a sawtooth oscillator such that the pitch determines the frequency of the speech. To get a natural sounding spoken voice, you should modulate the pitch of this oscillator with a slow sine LFO to simulate the emphasis.

Easy Setup for working with the Vocoder



Building a Vocoder setup

1. Connect the audio input of your microQ with a 1/4-inch mono or stereo plug. In practice, a so-called "insert" or "Y" cable is perfect for a stereo or dual mono signal input for the vocoder. Please be sure to use a line signal. If you want to use a microphone be sure to use a pre amplifier to generate a line signal.
2. With the **Input Gain** parameter in the Global menu you can increase the sensitivity. Please refer to the chapter „Global Parameters“ on page 130 for more details.
3. Select a sound program. We recommend the use of sustained pad or string sound.
4. Select the Vocoder as effect type for FX slot 1 or 2 and initialize the parameters. This is done by holding the **Shift** button while moving the left or right display parameter dial:

```
[FX default]
Vocoder 1 127
```

5. Feed the microQ's audio input with your external signal and trigger one or more notes. You should hear the vocoder effect. We recommend using speech or drum loops as external audio material.
6. Try different settings of the vocoder parameter and tune to taste.



First we recommend the use of the vocoder preset patches at the end of bank C in the microQ's factory soundset.

Bands 002...025

Sets the number of filter bands. A setting of 25 bands results in a very fine frequency resolution, so that the original signal is almost completely preserved by the synthesis filters. For a classic sounding Vocoder effect, you should set the number of bands to values between 13 and 22 bands.

Analysis Signal External/Aux/Inst.1 FX/Inst.2 FX/Inst.3 FX/Inst.4 FX/Main in/Sub1 in/Sub2 in

Determines the source of the signal that is analyzed. This signal is also known as Speech signal. The synthesis signal always comes from the current sound. This is not a real limitation because the voice architecture isn't affected at all by the Vocoder. You still have all three oscillators and two filters.

- *External* means that the source is the audio signal that comes from the External In jack ❶.
- *Aux* means that the source is the audio signal that comes from the internal Aux bus. Please refer to the chapter "Multimode" on page 40.
- *Inst.1 FX...Inst.4 FX* means that the source is the audio signal that comes from the internal FX bus. Please refer to the chapter "Multimode" on page 40.
- *Main in* means that the source is the summed audio signal that is routed to the microQ's **Main Out** jack ❷.
- *Sub1 In* means that the source is the summed audio signal that is routed to the microQ's **Sub Out 1** jack ❸.



You achieve the best results with external signals when you set **Input Gain** in the **Global Edit** to 1 or 2 for line level signals.

A. Lo Frq and A. Hi Frq 10.9Hz...16.7kHz

Set the frequency of the lowest and highest analysis bands respectively. You should set **A. Lo Frq** to around 220Hz and **A. Hi Frq** to 14kHz for voice analysis (the default values) or to around 100Hz and 16kHz for drum loops or other signals with a lot of bass and treble.

All other analysis bands are spread equally between these two bands.



If you find that the Vocoder isn't tracking quite right, then you might want to narrow the frequency range of the analysis bands.



If you want to extract one instrument from a complex sum, you should set **Bands** to 2 and change **A. Lo Frq** and **A. Hi Frq** until you find the signal's main frequency range. So you can, for example, process a full sounding String Pad to be emphasized on the Snare Drum or Hihat figure of a drum loop.

S. Offset -64...+63

Sets the relative offset of the lowest *synthesis* band compared with the lowest *analysis* band. A setting of *0* means that the lowest *synthesis* band has the same frequency as the lowest *analysis* band. *+63* means that the lowest *synthesis* band has the same frequency as the highest *analysis* band. Negative values mean that the lowest *synthesis* band is even lower than the *analysis* band.

Hi Offset -64...+63

Sets the relative offset of the highest *synthesis* band compared with the highest *analysis* band. When you set it to *-64*, it is tuned to the lowest *analysis* band.

All other *synthesis* bands are spread equally between these two bands.

 When you set **S. Offset** (the low offset) to *+63* and **Hi Offset** to *-64*, the *synthesis* frequency bands are arranged inversely compared with the *analysis* bands, so you get a flipped Vocoder.

Bandwidth -64...+63

Controls the width of the *synthesis* bands. Negative values result in wider bands while positive values result in narrower bands. *0* is the *ideal* Vocoder setting but it's up to you if you want other widths.

Resonance -64...+63

Controls the impulse response of the *synthesis* bands. Again, *0* results in an *ideal* Vocoder effect while you can remove resonance to make the vocoded signal less defined, or add resonance to get bell-like sounds.

Attack 000...127

Controls the rate of rise of the *synthesis* bands until they reach the level evaluated by the respective *analysis* band. For real Vocoder sounds, set it between *0* and *15*.

Decay 000...127

Controls the decay rate of the *synthesis* bands until they reach minimum volume. For real Vocoder sounds, set it between *10* and *25*. Shorter values might result in uneven volume changes of individual bands while longer values smear the signal. Both can be nice, but if the results aren't as you've expected, try changing this parameter.

 When you set **Decay** to *127*, you get a Resonator effect. Be careful with the input signal volume when doing so.

EQ Low Band Level and EQ High Band Level -64...+63

Control the overall weighting of all *synthesis* bands by ± 18 dB. When you set both to the same level, the filters are all equal in volume, if you set one of them to a different value, all filters in-between are scaled proportionally.

EQ Middle 001...025

Selects the band that is emphasized or attenuated by Mid Level. The surrounding bands are scaled to match the level of the Middle EQ.

Mid Level -64...+63

Emphasizes or attenuates the band selected with **EQ Middle** by ±18dB.

i The following FX types are not available for the microQ lite and can only be selected for **FX2**.

Reverb

The Reverb effect is probably the most widely used effect in music production. It is used to add a realistic ambience to clean and dry audio recorded in a studio. Very complicated mathematical algorithms are needed to simulate the complexity of a natural reverb. As a result, good reverb processors are very expensive. The microQ’s reverb effects don’t intend to simulate the perfect natural room, rather they are an addition to the microQ’s sound synthesis to make it more 3 dimensional and expressive.

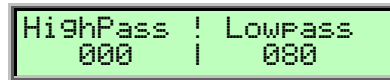

HighPass 0...127

Determines the frequency where the lower frequency parts are divided from the effect signal. This parameter works in the same way as the highpass filter in the microQ’s sound synthesis. A natural reverb doesn’t produce all frequencies equally so the highpass cuts the lower frequencies to produce a more realistic reverb effect.

Lowpass 0...127

Determines the frequency where the higher frequency parts are divided from the effect signal. This parameter works in the same way as the lowpass filter in the microQ’s sound synthesis. A natural reverb doesn’t produce all frequencies equally so the lowpass cuts the higher frequencies to produce a more realistic reverb effect.

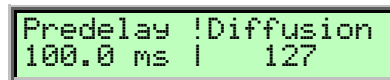

Predelay 0...300ms

Determines the delay in milliseconds between the direct sound and the reverb effect output. A natural reverb contains a reflexion which is heard later than the original signal. The predelay determines this delay so that the reverb is separated from the original sound. Lower settings connect the reverb more to the original signal while higher settings separate the effect signal to produce a more spacious sound.

Diffusion 0...127

Determines the consistency of different room materials. Lower settings produce a cold strong reflection like a metal or tile wall. Higher settings make a warm and thick reverb as if the signal were reflected by a uneven surface. Settings above 100 change the room characteristic even further.



Size 3m...20m

Determines the length of the longest room side in meters. Lower settings simulate a normal room while higher settings simulate a big hall or church.

Shape *0...127*

Changes the characteristic of the reverb. In most effect units you can select different rooms and reverb types like plate or echo chamber. The **Shape** parameter enables stepless changes of these reverb types. Lower settings simulate a more natural reverb while higher settings simulate a plate reverb.

```
Decay | Damping
100  | 100
```

Decay *0...127*

Determines the length of the reverb reflections. To simulate a big room choose higher Decay settings, to simulate a smaller room choose lower settings.

Damping *0...127*

Determines how fast the room simulation dampens the higher reverb frequencies. Higher frequencies are not dampened not as much as lower frequencies. This phenomenon makes a natural echo sound somewhat hollow. Higher values of the Damping parameter mean more high frequencies will be dampened.

Surround Delay Types

Along side current wide-spread use of stereo recording technology, multiple channel recording techniques have recently established themselves particularly in film audio. Thanks to the rise of DVD, consumer expectations of audio in general have increased. Music-only recordings done as surround productions are not unusual anymore. For this reason, the effects in the microQ have been expanded to include two Surround Delays.

The term „5.1“ means that 6 channels will be supported at the same time; 2 front speakers, 2 rear speakers, and one center channel speaker build up the normal 5 tone channels (5.x) where the loudspeakers surround the listener in a circle. The sixth channel supports the so-called LFE channel (Low Frequency Effects) which is almost always connected to a subwoofer (x.1).

To use the full performance of the surround delays please connect the microQ’s audio outputs to your mixing unit or to a special surround amplifier as follows:

 **Output setup of the microQ when using the surround delays:**

- Main Out L+R outputs the signal for the front speaker L+R
- Sub Out 1 L+R outputs the signal for the rear speaker L+R
- Sub Out 2 L outputs the signal for the center speaker
- Sub Out 2 R outputs the LFE signal for the subwoofer

5.1 Delay

This delay type produces different echoes of the input signal and sends them to the corresponding audio outputs of the microQ (refer to the text above).

```
Delay | Feedback
1.48 s | 100.0 %
```

Delay *1.4ms...1.48s*

Sets the length of the SurroundDelay in milliseconds.

Feedback *0...100%*

Controls the amount of signal that is routed back into the Delay line. Lower values therefore produce fewer echoes than higher values.

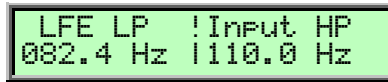

LFE LP *10.9Hz...16.7kHz*

Determines the crossover frequency below which the effect signal is routed to the LFE channel output (Sub Out 2 R). If you want to make a typical „5.1 mix“ a setting of *80 Hz* is recommended.

Input HP *10.9Hz...16.7kHz*

Determines the highpass crossover frequency for all effect signals except for the LFE. The **Input HP** is used to adjust the bass frequencies for all channels independently from the LFE channel.



FSL Volume *0...127*

Determines the volume of the effect signal for the left Front Speaker (Main Out L).

Delay ML *0%...400%*

Determines the relative delay of the effect signal pertaining to the setting of the **Delay** parameter.

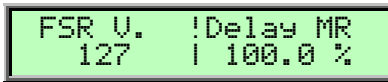

FSR Volume *0...127*

Determines the volume of the effect signal for the right Front Speaker (Main Out R).

Delay MR *0%...400%*

Determines the relative delay of the effect signal pertaining to the setting of the **Delay** parameter.

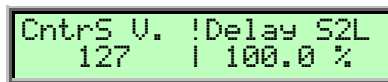

CntrS Volume *0...127*

Determines the volume of the effect signal for the Center Speaker (Sub Out 2 L).

Delay S2L *0%...400%*

Determines the relative delay of the effect signal pertaining to the setting of the **Delay** parameter.

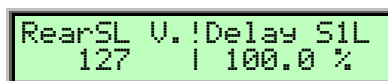

Rear SL Volume *0...127*

Determines the volume of the effect signal for the left Rear Speaker (Sub Out 1 L).

Delay S1L *0%...400%*

Determines the relative delay of the effect signal pertaining to the setting of the **Delay** parameter.

```
RearSR V. !Delay S1R
127 | 100.0 %
```

Rear SR Volume *0...127*

Determines the volume of the effect signal for the right Rear Speaker (Sub Out 1 R).

Delay S1R *0%...400%*

Determines the relative delay of the effect signal pertaining to the setting of the **Delay** parameter.

5.1 D.Clk

This surround delay type is similar to the **5.1 Delay**. With this delay type, the delay time is synchronized to the microQ's internal tempo. For more information about tempo settings refer to the chapter „The Tempo“ on page 124.

```
Delay !Feedback
1/4 | 100.0 %
```

Delay *1/128...8/4.*

Sets the length of the delay tap in note values. A „t“ behind the number means a triplet note value while a „.“ Behind means a dotted note.



All other parameter of the **5.1 D.Clk** Delay are identical to the **5.1 Delay**.

Arpeggiator

An Arpeggiator is a device that splits an incoming MIDI chord into its single notes and repeats them rhythmically. Different sequence modes can be defined for the Arpeggiator to cover a wide range of applications. In addition to the synthesis features, the microQ offers a deeply programmable Arpeggiator for every sound program. It can play a wide range of different rhythm patterns including accents and different timings, and allows creating sophisticated custom rhythm patterns.

The arpeggiator uses a so-called note list that can store up to 16 notes. This list is set up depending on the Arpeggiator parameter settings. For example, when **Sort Order** is set to *Num Lo>Hi*, the list is rearranged so that the lowest note is placed at the first position, the second lowest note at the next and so on. Refer to the individual parameter descriptions to see if and how a parameter alters the list.

Arpeggiator Parameter Controls

The most commonly used controls of the Arpeggiator can be directly accessed via the Amp/FX/Arp section.

Arp Mode *Off / On / One Shot / Hold*

This parameter sets the way the Arpeggiator works.

- If *Off* is selected, the arpeggiator is not active.
- If *On* is selected, the arpeggiator is active. When you press a note or a chord on the keyboard, it is split up and repeated rhythmically. As soon as you release a note, it is removed from the arpeggio rhythm. Conversely, as soon as you add another note to the existing chord, it is inserted into the arpeggio. When you release all notes, the arpeggiator stops.
- If *One Shot* is selected, the arpeggiator splits up all played notes and plays back an arpeggio. The actual length of this arpeggio is set by the **Pattern Length** parameter. After the arpeggio rhythm is played once, it is stopped automatically unless you hit a new chord. This mode is especially useful in a live performance where you might have to “synchronize” yourself, for example, to a drummer. Just hit a chord at each new bar.
- If *Hold* is selected, the arpeggiator splits up all played notes and generates a continuous arpeggio even when the chord is released. This gives you two ways of entering a chord:
 1. Press all keys of the chord simultaneously. This is the normal procedure you would follow with the other Arpeggiator Modes, too.or
 2. Press and hold the first key of the chord. While holding this key, enter the other keys sequentially. After playing all keys, you can release the first key. On one hand this method is practical for playing difficult chords, and on the other hand it is essential when using the *as played* setting of the **Sort Order** parameter. This setting allows you to create arpeggios in the sequence of played notes. You can even hit the same note several times and it will appear in the note list accordingly.



You can stop playback of the Arpeggiator by pressing the **Power/Panic** button, by setting **Mode** to *Off*, *On* or *One Shot*, or by sending an All Notes Off message from your sequencer.

Range *1 Oct...10 Oct*

Determines the range of the single notes in octaves. When it is set to *1 Oct*, the note list will be played back in the same octave as originally entered. Greater values mean that the note list is repeated in higher or lower octaves. The octave in which the arpeggio starts is determined by the **Direction** parameter. If you play notes that span more than one octave, they are still kept in the note list and played back before the note list is transposed. The following table shows some possible arpeggios, all set to **Sort Order** as played:

Note input	Range	Direction	Resulting Arpeggio
C1 E1 G1	1 Oct	Up	C1 E1 G1 C1 E1 G1
C1 E1 G1	2 Oct	Up	C1 E1 G1 C2 E2 G2 C1 E1 G1 C2
E1 G1 C1	3 Oct	Up	E1 G1 C1 E2 G2 C2 E3 G3 C3 E1
C1 G1 E2	3 Oct	Up	C1 G1 E2 C2 G2 E3 C3 G3 E4 C1
C1 E1 G1	3 Oct	Down	G3 E3 C3 G2 E2 C2 G1 E1 C1 G3
C1 E1 G1	2 Oct	Alt Down	G2 E2 C2 G1 E1 C1 E1 G1 C2 E2

Table 10: Arpeggio results depending on note input

Tempo *40...300*

The basic tempo of the Arpeggiator is set by this global **Tempo** control that also controls the behaviour of the LFOs and Envelopes. This allows you to change all tempo-related aspects of the sound with one single turn of the **Tempo** control. Please refer to the chapter “The Tempo” on page 99.

Clock

Please refer to the chapter “The Tempo” on page 124.

Arpeggiator Parameter of the Amp/FX/Arp Edit Menu

To reach the Arpeggiator parameters in the Amp/FX/Arp Edit Menu, press the **Edit** button and choose the parameter pages you wish to edit.

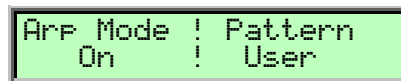
**Arp Mode** *Off / On / One Shot / Hold*

See "Arpeggiator Parameter Controls" in the Amp/FX/Arp section on page 100.

Pattern *Off / User / 1...15*

Sets the rhythm pattern that is used for generating the arpeggio. If **Pattern** is set to *Off* or to one of the 15 ROM patterns and **T.Factor** is set to a value greater than 0, the sequence is played back with a Shuffle or Swing effect. This means that the off-beat steps are played back slightly later in time.

- If *Off* is selected, the arpeggiator plays back a continuous sequence of notes with the current **Clock** setting.
- *User* gives you the ability to create your own custom rhythm pattern. This pattern is stored in the sound. See the section "Arpeggiator Step Data Pages" below about the pattern settings you can create.
- *1...15* selects one of the 15 internal ROM rhythm patterns. See the table below for an overview of each ROM rhythm pattern:

Pattern	1	2	3	4	5	6	7	8	9	10	11	12	13	14	15	16
1	●		●	●	●		●	●	●		●	●	●		●	●
2	●		●		●			●	●		●		●			●
3	●		●		●		●	●	●		●		●		●	●
4	●		●	●	●		●		●		●	●	●		●	
5	●		●		●	●		●	●		●		●	●		●
6	●	●		●		●	●		●	●		●		●	●	
7	●		●		●		●		●	●		●		●		●
8	●		●		●		●	●		●		●	●		●	
9	●	●	●		●	●	●		●	●	●		●	●	●	
10	●	●		●	●		●	●		●	●		●	●	●	
11	●	●		●	●		●	●		●	●		●		●	
12	●	●		●	●		●		●	●		●		●		
13	●		●		●		●		●	●		●		●	●	●
14	●			●			●		●	●			●			●
15	●		●		●		●		●			●		●		

Picture 29: Arpeggiator patterns

i Note that you can edit a ROM pattern to create your own rhythms starting from an existing ROM pattern. As soon as you do so, the ROM pattern is copied to the User pattern and the previous User pattern is overwritten.

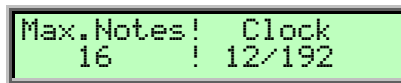

Max. Notes 1...16

Sets the maximum number of notes that are used for the note list. When you press more notes than set up here, the oldest notes are removed from the list. This feature is particularly interesting in Multi Mode. When you set it to 1 on a Bass sound, for example, the Arpeggiator only stores the last entered note and plays back sequentially. All other notes might still be used by other sounds, but the Bass sound plays back only this one particular note.

Clock 1/32t...1/1

Sets the note value for the steps of the rhythm pattern in a range from whole notes to thirty-second triplet notes. Triplets (e.g. 1/8T) and dotted notes (e.g. 1/16.) are available for every note value.

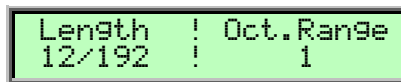

Length 1/192...127/192 / legato

Sets the length of the generated arpeggio notes. When **Length** is set to a value between 1/192 and 127/192, the **Arp Steplen** parameter lets you change the relative length of each step. However, when **Length** is set to *legato*, all arpeggio notes are played without pauses between each step and **Arp Steplen** therefore has no effect.

Oct.Range 1...10

See "Arpeggiator Parameter Controls" in the Amp/FX/Arp section on page 92.

```

Direction!SortOrder
UP      !as Played

```

Direction *Up / Down / Alt Up / Alt Down*Sets the direction that is used to play back the arpeggio. This parameter is closely related to **Oct.Range** and **Sort Order**.

- If *Up* is selected, the note list is played forward and the octaves are transposed upward. The arpeggio starts in the original octave and goes up to the highest octave set by **Range**. Then the arpeggio is repeated.
- If *Down* is selected, the note list is played backward and the octaves are transposed downward. The arpeggio starts in the highest octave set by **Range** and goes down to the original octave. Then the arpeggio is repeated.
- If *Alt Up* is selected, the note list is first played forward and the octaves are transposed upward. After reaching the last note of the note list in the highest octave to play, the note list is played backward and the octaves are transposed downward down to the first note of the note list in the original octave. Then the arpeggio is repeated.
- If *Alt Down* is selected, the note list is first played backward and the octaves are transposed downward. The arpeggio starts in the highest octave set by **Range**. After reaching the first note of the note list in the original octave, the note list is played forward and the octaves are transposed upward up to the last note of the note list in the highest octave to play. Then the arpeggio is repeated.

SortOrder *as played / reversed / Num Lo>Hi / Num Hi>Lo / Vel Lo>Hi / Vel Hi>Lo*

Sets the order in which the note list is arranged. With this parameter, you can determine how the notes you originally play are split up for the arpeggio.

- If *as played* is selected, the notes are sorted in the exact order you played them. If you e.g. press E1, G1 and C1, the note list looks exactly like that.
- If *reversed* is selected, the notes are sorted to the reverse order in which you played them. If you e.g. press E1, G1 and C1, the note list is sorted to C1, G1 and E1.
- If *Num Lo>Hi* is selected, the notes are sorted from the lowest note to the highest note. If you e.g. press E1, G1 and C1, the note list is sorted to C1, E1 and G1.
- *Num Hi>Lo* is the opposite of *Num Lo>Hi*. The example would be sorted as G1, E1 and C1.
- If *Vel Lo>Hi* is selected, the notes are sorted from the softest to the loudest velocity. If you press notes with velocities 64, 120 and 96, the note list will be sorted to 64, 96 and 120.
- *Vel Hi>Lo* is the opposite of *Vel Lo>Hi*. The above notes would be sorted as 120, 96 and 64.

```

Vel Mode !T.Factor
EachNote ! 000

```

Vel Mode *Each Note / First Note / Last Note*Determines how velocity is interpreted in the arpeggio. Note that each arpeggio step might have an additional positive or negative offset set by the **Arp Accent** parameter.

- If *Each Note* is selected, each note of the arpeggio is played back with the velocity that you originally played.
- If *First Note* is selected, the first note you played sets the velocity for all arpeggio steps.
- If *Last Note* is selected, the last note you played sets the velocity for all arpeggio steps.

T. Factor 0...127

Determines how much the **Arp Timing** parameter affects an arpeggio step. If **T. Factor** is set to 0, the settings in **Arp Timing** are completely ignored and the arpeggio is played back without any shuffled timing. Settings from 1 to 127 increase the shuffling of the notes depending on the setting in the **Arp Timing** parameter. **T. Factor** also works on ROM patterns; these are set up with standard swing rhythm.

Same Note Overlap Off / On



Due to the various **Length** parameters, it might happen that two notes having equal pitch overlap, e.g. when you play only one single note on a 16 beat rhythm with lengths set to 1/8.

Note that this parameter only affects notes of the same pitches. If you want to control the lengths of notes of different pitches, use the **Length** or **Arp Steplen** parameters.

- If *On* is selected, the Note Off message of the previous note is allowed to be sent after a Note On message of the next note with the same pitch. This setting can be nice with arpeggios triggering sounds with slow attack.
- If *Off* is selected, the Note Off message of the previous note is sent right before the next note with the same pitch is started.

Pattern Reset Off / On



When all steps of an arpeggio pattern are played back, the pattern is repeated from the beginning so that the arpeggio is looped. With **Pattern Reset**, you can decide if the note list is also restarted from the beginning when the rhythm pattern is reset.

- If *Off* is selected, the note list is not restarted, so that there is no synchronization between rhythm and note list. E.g., when you have a pattern where four steps are set and you play three notes, the pattern and the note list are repeated differently. The pattern restarts after the fourth step while the note list restarts after the third step. The arpeggio might look like this:

Pattern Step	1	2	3	4	1	2	3	4	1	2	3	4	1	2	3	4
Note	C1	E1	G1	C1	E1	G1	C1	E1	G1	C1	E1	G1	C1	E1	G1	C1

Table 11: Arpeggio with Pattern Reset set to On

- If *On* is selected, the note list will be restarted as soon as the rhythm pattern is restarted. The same arpeggio might now look like this (note the two C1s in sequence):

Pattern Step	1	2	3	4	1	2	3	4	1	2	3	4	1	2	3	4
Note	C1	E1	G1	C1	C1	E1	G1	C1	C1	E1	G1	C1	C1	E1	G1	C1

Table 12: Arpeggio with Pattern Reset set to Off

Pattern Length 1...16



Sets the length of the rhythm pattern. This parameter is also valid when **Pattern** is set to *Off* or if one of the ROM patterns is selected. Note that you can only edit a particular step in the **Step Data** pages when its position is within the range of the **Pattern Length** parameter.

Arpeggiator Step Data Pages

The following Arpeggiator menu pages all behave similarly. The left value dial sets the step that should be changed while the right value dial changes the value of the step according to the possible value range.

i You can only select the steps that are in the range set by **Pattern Length**. E.g., when you have set **Pattern Length** to 8, you can't change a value of step 9 or above.

Arp Accent *, ♯, ♭, ♮, -, +, ◊, ◻



Sets the accent of a particular step. This accent is interpreted as a velocity offset that is added or subtracted from the original velocity stored in the note list. However, the generated velocities can never exceed the maximum MIDI velocity 127 or minimum MIDI velocity 1. This means when you have already played notes with a high velocity, **Arp Accent** might not be able to further offset them positively, so you will only hear differences with negative accent offsets. Conversely, low velocities might not be able to be lowered by **Arp Accent**. The only exception is *. See the following description:

- If * is selected, the current step is actually played, but inaudible. This means that the note list is advanced by one note, but you are not able to hear it. This feature is the opposite to **Arp Step** set to *Off*, which doesn't generate any note and therefore doesn't advance the note list.
- If - is selected, the velocity of the current step is not altered. The arpeggio steps are played back with their original velocity.
- If **Arp Accent** is set to any positive or negative value, the velocity is raised or lowered accordingly. Each step adds or subtracts 15 from the original velocity.

Arp Glide off / ~



For each step in the arpeggio pattern you can activate the glide effect individually. This gives you the ability to create the classic "Bass Line" melody character. Make sure that you set up a reasonable glide effect in the Oscillator Edit menu.

- If *off* is selected (empty space), the glide effect is disabled for this step.

- If  is selected (legato symbol), the glide effect is enabled for this step. This means that the previous note glides to the note that has to be played at this particular position in the arpeggio.

 Please note that **Glide** in the Oscillators Edit menu must be set to *Off* when you want to set Arp Glide for individual pattern notes. Otherwise, the glide effect will occur on all notes.

Arp Step

* / - / < / > / * /  / ?

```
Arp Step
01[*?***-**-?*?*]
```

This parameter can have a pronounced effect on the resulting arpeggio, so you should read the following paragraphs carefully. **Arp Step** basically determines which note of the note list is played at a particular step. You can also force the Arpeggiator to play a whole chord or part of a chord or set it up to play a random note from the list.

- If * is selected (asterisk symbol), the Arpeggiator plays the step unaltered. The note list is advanced beforehand, except when you press a new chord.
- If *off* is selected (empty space), the Arpeggiator plays nothing at this step position. When **Length** or **Steplen** is set to *legato*, the previous step that isn't set to *Off* is still held to create the legato effect. The note list is not advanced.
- If - is selected, the Arpeggiator plays the same note as it had to play in the previous step that was set to * or ?. With this setting, you can repeat a particular note of the note list several times. The note list is not advanced.
- If < is selected, the Arpeggiator plays the very first note of the note list. This might be interesting if you want to only play the "root note" of a chord in a bass sound. The note list is not advanced.
- If > is selected, the Arpeggiator plays the very last note of the note list. The note list is not advanced.
- If * is selected, the Arpeggiator plays a chord with two notes, the first and the last one of the note list. This means that you have to play at least two notes to hear the effect. Otherwise, you would hear only one note anyway. The note list is not advanced.
- If  is selected (notes symbol), the Arpeggiator plays a chord with all notes from the note list. This means that you have to play at least two notes to hear the effect. The note list is not advanced.
- If ? is selected, the Arpeggiator plays a random note from the note list. This doesn't mean that it creates a note randomly; instead it uses one note of the existing note list. The note list is not advanced.

As you can see, the effects can differ greatly depending on what you set up here. The following arpeggio shows an example of the effect when the notes C1, E1 and G1 are pressed:

*		*	-	*	*	*	<	*	*	>	∞	*	♩	*	?
C1	-	E1	E1	G1	C1	E1	C1	G1	C1	G1	C1+ G1	E1	C1+ E1+ G1	G1	C1 or E1 or G1

Table 13: Arp Step example

Arp Timing

? / † / # ... #



Moves the playback time of a step forward or backward. Forward means that a step is played later while backward means that it is played earlier. The overall strength of this parameter is set by **T. Factor**. If **T. Factor** is set to 0, **Arp Timing** has no effect on the rhythm at all. If **T. Factor** is set to maximum, **Arp Timing** can move the step by a maximum of half the clock division. This means that it can move the step by 1/32 forward or backward when clock is set to 1/16.

- ? moves the step forward or backward at random. It might also be played without being moved.
- Values pointing to the left (# , # and †) move the step backward so that it is played earlier. † means that the step is moved by a third, # means that it is moved by two third and # means that it is moved fully.
- If a vertical line (†) is shown, the step isn't moved at all. It is played at the standard clock position.
- Values pointing to the right move the step forward so that it is played later. † means that the step is moved by a third, # means that it is moved by two third and # means that it is moved fully.

Arp Steplen

~ / † / # ... #



Changes the length of the note of a particular step. The overall length of the arpeggio depends on the **Length** setting. If **Length** is set to *legato*, **Arp Steplen** doesn't have any effect at all. Also, if **Length** is set to a very small value, **Arp Steplen** might not have an audible effect when you set it to a negative value. You can create very nice staccato and legato effects with this parameter.

- If ~ is selected, the notes of this step are held until the next step is played. Empty steps force any step notes set to legato to remain held.
- Values pointing to the left († , # , #) shorten the length of the notes of this step.
- If a vertical line (†) is shown, the step is held for the time set in the Length parameter.
- Values pointing to the right († , # , #) extend the note duration of this step.

Envelopes Section

The microQ's envelopes allow you to manipulate sound parameters via rate or timed modulations. The microQ offers four independent programmable envelopes for every sound program:

- A Filter Envelope. This envelope is designed to control the filter but can also be used for other modulations.
- An Amplifier Envelope. This envelope is designed to control the sound volume, but can also be used for other modulations.
- Two additional Envelopes, Env 3 and Env 4. These envelopes can be used freely to perform additional modulations on any module.

The following picture of the microQ's parameter matrix shows the Envelopes section:



Picture 30: Envelope Section

Before you make any edits to the envelopes, you must select whether to edit the Filter and the Amplifier Envelope or Envelope 3 and 4. This is done by pressing the left or right navigation button. The four LED in the Envelope section indicate which envelopes are selected for editing:

- **F** means the Filter envelope
- **A** means the Amplifier Envelope
- **3** means Envelope 3
- **4** means Envelope 4



To edit more than one envelope at the same time, hold down the left navigation button and push the right navigation button once for as many envelopes as you wish to select.

Envelope Parameter Controls

All parameters of the microQ's envelopes can be edited via the Parameter Matrix.

The microQ offers 5 different envelope types. Their parameters are described here in order. Some envelope types do not use the full number of parameters available to the envelope section.

Mode

ADSR / ADS1DS2R / One Shot / Loop S1S2 / Loop All

Switches between the various envelope types. The following chapters explain the types in detail.

ADSR Envelope

Most traditional synthesizers feature ADSR envelopes. These envelopes are made up of four parameters that determine their response: **Attack**, **Decay**, **Sustain** and **Release**. The other parameters of the Envelope section have no function, so they can not be edited. The following picture illustrates the structure of an ADSR envelope:

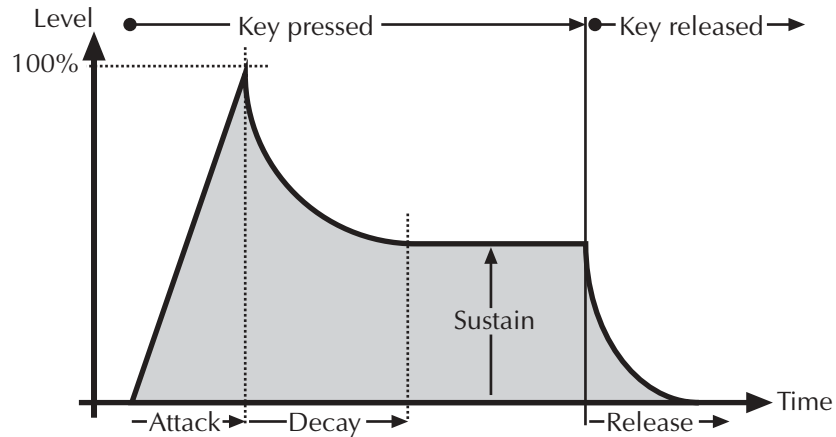

Picture 31: ADSR Envelope

The envelope is started by pressing a key. It ascends to its maximum value at the rate determined by the **Attack** parameter. It then descends at the rate determined by the **Decay** value until it reaches the predetermined **Sustain** value. It remains at this value until the key is released. The envelope then descends to zero at the rate determined by the **Release** parameter.

Attack $0..127$

Determines the attack rate or amount of time it takes for a signal to go from zero to maximum level.

Decay $0..127$

Determines the decay rate or amount of time it takes for a signal to reach the **Sustain** level.

Sustain $0..127$

Determines the sustain level which is held until a note ends.

Release $0..127$

Once the note has ended, the release phase begins. During this phase, the envelope fades to zero at the rate determined by the Release value.

ADS1DS2R Envelope

A difficult name for an envelope that is quite easy to understand. Besides the parameters an ADSR envelope features, it offers an adjustable attack level and a second Decay and Sustain pair. With these additional parameters, you can create much more complex envelopes. The additional envelope parameters are accessed through the **Shift** button.

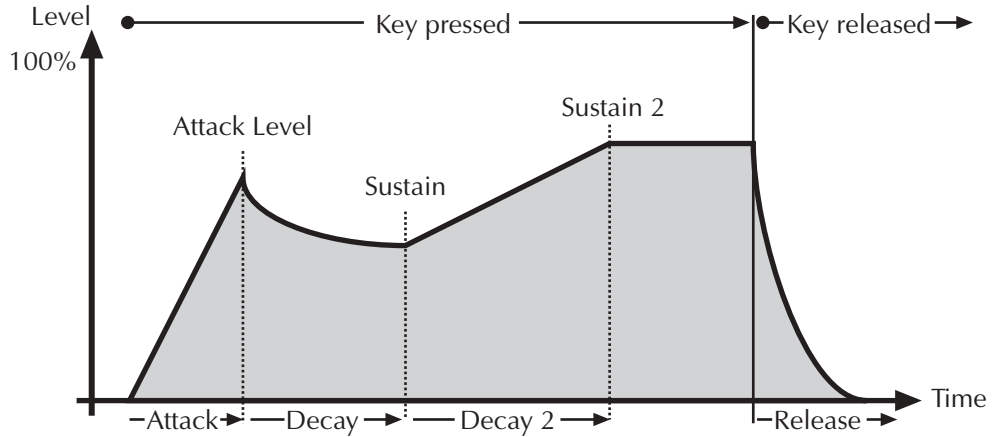

Picture 32: ADS1DS2R Envelope

Attack *0...127*

Determines the attack rate or amount of time it takes for a signal to go from zero to Attack level.

Attack Level *0...127*

Controls the level at each the **Attack** phase ends and the **Decay** phase starts.

Decay *0...127*

Determines the decay rate or amount of time it takes for a signal to reach the **Sustain** level.

Sustain *0...127*

As soon as the **Sustain** level is reached, the envelope proceeds with the second **Decay/Sustain** pair as explained below.

Decay 2 *0...127*

Determines the decay rate or amount of time it takes for a signal to reach the **Sustain 2** level.

Sustain 2 *0...127*

Determines the level which is maintained until a note ends.

Release *0...127*

Once the note is released, the release phase begins. During this phase, the envelope fades to zero at the rate determined by the Release value.

One Shot Envelope

The One Shot envelope type is designed for percussive sounds that don't need a stage maintained as long as a note is played. In other words: the envelope goes through all its stages, no matter how long a key is pressed. This includes even the Attack phase. It uses the parameter set of the ADSR envelope type in which the **Sustain** parameter is used to set a level breakpoint. This allows creation of One Shot envelopes with a very percussive attack or with a "Gate" effect. Some parameters of the Envelope section have no function so they can not be edited.

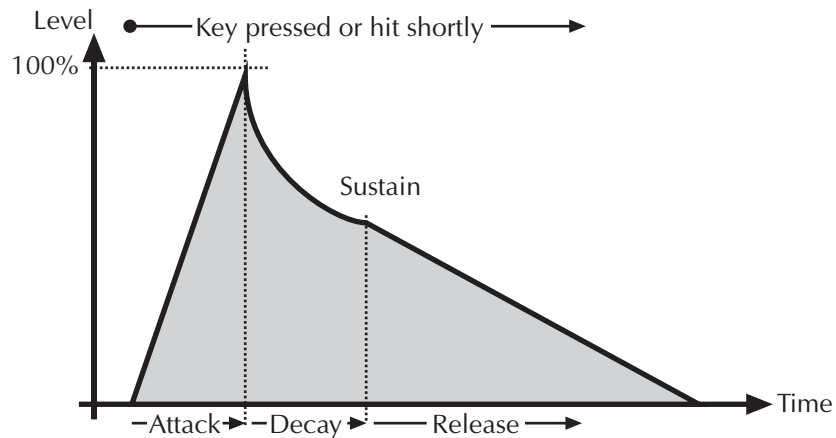

Picture 33: One Shot Envelope

Attack $0..127$

Determines the attack rate or amount of time it takes for a signal to go from zero to maximum level.

Decay $0..127$

Determines the decay rate or amount of time it takes for a signal to reach the **Sustain** level.

Sustain $0..127$

Sets a breakpoint level between the Decay and the Release rate.

Release $0..127$

The Release phase fades the envelope to zero after the Sustain level is reached.

Loop S1S2 Envelope

The Loop S1S2 envelope type loops the envelope between **Sustain 1** and **Sustain 2** as long as a note is held, after has been through the **Attack** phase once. This means that when **Sustain 2** is reached, **Decay 1** is used to reach **Sustain 1** again, then **Decay 2** is used to reach **Sustain 2**, and so on. As soon as the note is released, the envelope proceeds with the **Release** phase. It uses the parameter set of the ADS1DS2R envelope.

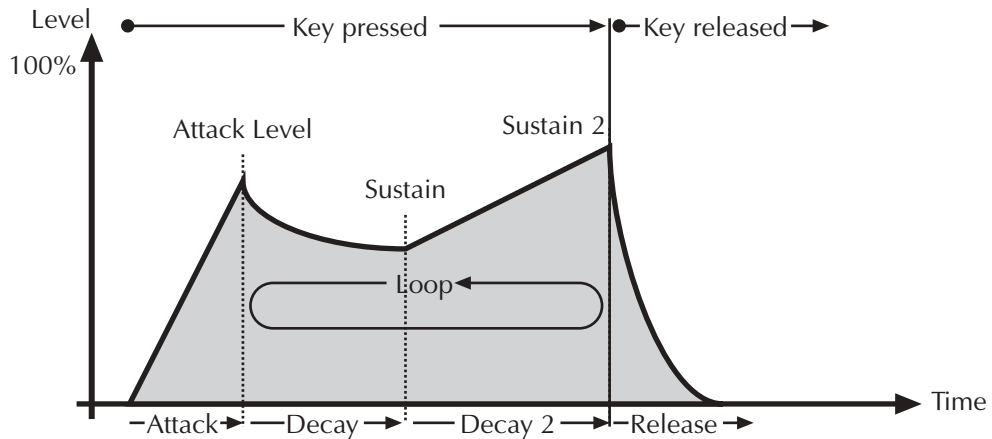

Picture 34: Loop S1S2 Envelope

Attack *0...127*

Determines the attack rate or amount of time it takes for a signal to go from zero to **Attack** level.

Attack Level *0...127*

Controls the level at which the **Attack** phase ends and the **Decay** phase starts.

Decay *0...127*

Determines the **Decay** rate or amount of time it takes for a signal to reach the **Sustain** level. This phase is also used in the loop to go from **Sustain 2** to **Sustain**.

Sustain *0...127*

As soon as the **Sustain** level is reached, the envelope proceeds with the second **Decay/Sustain** pair as explained below.

Decay 2 *0...127*

Determines the decay rate or amount of time it takes for a signal to reach the **Sustain 2** level.

Sustain 2 *0...127*

Sets the second **Sustain** level. As soon as this level is reached, the loop starts by using the first **Decay** rate to go to the first **Sustain** level.

Release *0...127*

Once the note is released, the release phase begins. During this phase, the envelope fades to zero at the rate determined by the Release value.

Loop All Envelope

The Loop All envelope type is similar to the Loop S1S2 envelope type but it loops through all envelope stages as long as a note is held. This means that it goes through all envelope stages first, and if it ended with the **Release** phase, the envelope restarts from zero and goes through all its phases again. As soon as the note is released, the looping stops and the envelope goes into its **Release** phase.

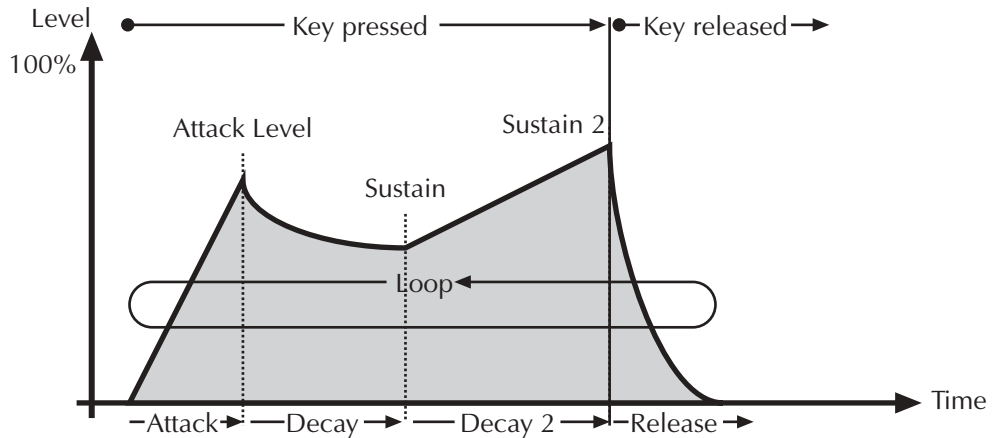

Picture 35: Loop All Envelope

Attack $0..127$

Determines the attack rate or amount of time it takes for a signal to go from zero to **Attack** level.

Attack Level $0..127$

Controls the level at which the **Attack** phase ends and the **Decay** phase starts.

Decay $0..127$

Determines the **Decay** rate or amount of time it takes for a signal to reach the **Sustain** level. This phase is also used in the loop to go from **Sustain 2** to **Sustain**.

Sustain $0..127$

As soon as the **Sustain** level is reached, the envelope proceeds with the second **Decay/Sustain** pair as explained below.

Decay 2 $0..127$

Determines the decay rate or amount of time it takes for a signal to reach the **Sustain 2** level.

Sustain 2 $0..127$

Sets the second **Sustain** level. As soon as this level is reached, the envelope goes into the **Release** phase.

Release $0..127$

The Release phase takes effect while the note is pressed, as last stage before the loop restarts with the Attack phase. When the note is released, the loop stops and the Release phase is used to fade the envelope to zero.

Envelope Edit Menu

You can select the edit menu for the envelopes by pressing the **Edit** button as soon as any envelope is selected.



Unlike all of the Edit Menus of the other sections, you cannot change any of these values with the knobs below the display. This Edit Menu simply serves as an overview. Parameter changes are done with the four endless dials ⑪ below the Parameter Matrix.

There are one or two Menu pages depending on what envelope type is chosen. The upper row of the display shows the chosen envelope and the type, and the lower row shows the corresponding values.

Filter Envelopes are shown here as an example for a normal ADSR-Type with corresponding values:

A rectangular LCD display with a green background and black text. The text is arranged in two lines. The first line reads 'F-Env:ADSR' and the second line reads 'A000 D010 S127 R030'.

```
F-Env:ADSR  
A000 D010 S127 R030
```

LFO Section

In addition to the main oscillators, the microQ is equipped with three low frequency oscillators (LFO) that can be used for modulation purposes. Each LFO generates a periodic waveform with adjustable frequency and shape.

The following picture of the microQ's parameter matrix shows the LFO section:



Picture 36: LFO section

LFO Parameter Controls

The most commonly used controls of the LFO can be found in the parameter matrix.

LFO 1 Speed *0...127 or 256 bars...1/96*

Determines the frequency of LFO 1. At low values, it might take several minutes for the LFO to perform a complete cycle while higher values are in the audible range. Very high values are scaled in semitone steps. With **LFO Keytrack** set to *100%*, a **Speed** setting of *122* delivers an *8'* LFO oscillation. *16'* oscillation can therefore be generated with a **Speed** setting of *110*, and so on.

When the LFO **Clocked** parameter is set to *On*, you can adjust the **LFO Speed** in musical values. The lowest possible value is *256 bars*, meaning that a complete LFO cycle would need 256 bars.

LFO 1 Shape *Sine / Triangle / Square / Saw / Random / S & H*

Sets the type of waveform generated by LFO 1. The following picture shows the available shapes:

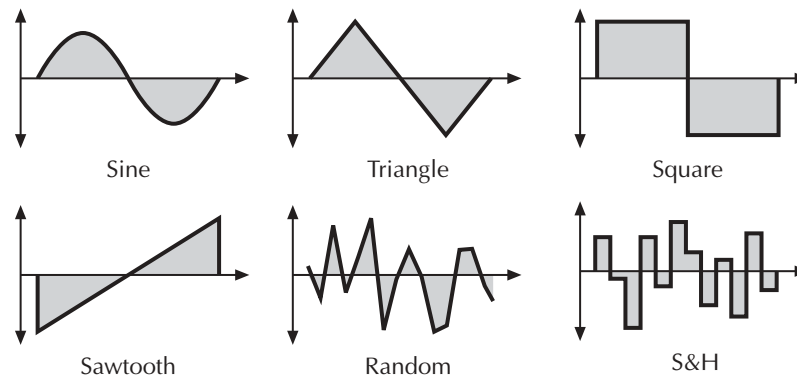

Picture 37: LFO Shapes

- The *Sine* shape is best suited for oscillator FM or pan modulations.
- The *Triangle* shape is perfect for smooth pitch, filter or volume modulations.
- The *Square* shape can be interesting for hard pan modulations or special effects.
- The *Sawtooth* shape can generate interesting filter or volume changes. If you need a modulation with inverted slope, just apply the Sawtooth shape with negative amount.
- The *Random* shape generates random values and glides to them linearly.
- *S&H* (Sample & Hold) samples a random value and holds it until the next value is generated. If **Speed** is set to *0*, a random value is generated on each new note.

Sync *Off, On*

When **Sync** is set to *On*, the LFO phases of all voices are synced so that they sound as one LFO. This can be interesting when the LFO is applied to modulate **Filter Cutoff** or **Panning**.

When **Sync** is set to *Off*, the LFOs run independently ; this is better suited for pitch modulation to obtain thicker sounds.

i **Sync** does not mean that the LFO is synced to MIDI Clock or to note start. This is done with the **Clocked** parameter or the **Phase** parameter.

LFO 2 Speed *0...127 or 256 bars...1/96*

Determines the frequency of LFO 2. See "LFO 1 Speed" above.

LFO 2 Shape *Sine / Triangle / Square / Saw / Random / S & H*

Sets the type of waveform generated by LFO 2. See "LFO 1 Shape" above.

LFO 3 Speed *0...127 or 256 bars...1/96*

Determines the frequency of LFO 3. See "LFO 1 Speed" above.

LFO 3 Shape *Sine / Triangle / Square / Saw / Random / S & H*

Sets the type of waveform generated by LFO 3. See "LFO 1 Shape" above.

LFO Edit Menu

The following parameters can be accessed via the LFO Edit menu. If you are in the LFO section press the **Edit** button to activate the display menu.

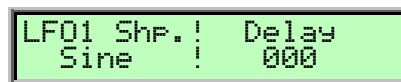

LFO1 Shp.–LFO1 Shape *Sine / Triangle / Square / Saw / Random / S & H*

Sets the type of waveform generated by LFO 1. For the sake of completeness this parameter can be also found here in the LFO Edit Menu. See "LFO 1 Shape" above.

Delay *0...127*

The **Delay** parameter works in different ways depending on the setting of the **Fade** parameter in the LFO edit menu:

- When **Fade** is set to *+00...+63*, the LFO signal output is zero for the time set with the **Delay** parameter. After this time, the LFO is faded in and then runs with full magnitude.
- When **Fade** is set to *-64...-01*, the LFO runs with full magnitude for the time set with the **Delay** parameter. After this time, the LFO is faded out to zero.

```

LF01 Spd. ! Fade
056      ! +20

```

LF01 Spd. – LFO 1 Speed *0...127*

Determines the frequency of LFO 1. For the sake of completeness this parameter can be also found here in the LFO Edit Menu. See "LFO 1 Speed" above.

Fade *out 64...in 63*

Controls the speed with which the LFO is faded in or out. With this parameter you can create slowly rising or falling modulations that might create interest when routed to pitch or volume.

i Please see the **LFO Delay** parameter on page 108 for further information.

```

LF01 Sync ! StartPhase
Off      ! free

```

LF01 Sync *On / Off*

For the sake of completeness this parameter can be also found here in the LFO Edit Menu. See "Sync" above.

Phase *free, 000°...360°*

Controls the initial phase of the LFO when a new note is started. *Free* means that the LFO isn't restarted on a new note but runs freely while other values set the LFO phase to the respective offset in degrees.

```

LF01 Clk ! Keytrack
Off      ! +000%

```

LF01 Clk - LFO 1 Clocked *Off / On*

When **LF01 Clk** is activated, the LFO is synced to the global **Tempo** of the microQ. The **LFO Speed** setting for LFO 1 is changed to offer musically meaningful values.

i Please read the section "The Tempo" on page 124 for further information.

Keytrack *-200%...+196%*

Determines how much the speed of the LFO depends on MIDI note number. The reference note for Keytrack is E3, note number 64. For positive settings, the LFO speeds up on notes above the reference note, for negative settings the LFO slows down when higher notes are played and vice versa. A setting of *+100%* corresponds to a 1:1 scale, e.g. when the keyboard is played an octave higher, the LFO speed is doubled.

```

LF02 Shp. ! Delay
Sine      ! 000

```

LF02 Shp. – LFO 2 Shape *Sine / Triangle / Square / Saw / Random / S & H*

Determines the shape of LFO 2. For the sake of completeness this parameter can be also found here in the LFO Edit Menu. See "LFO 2 Shape" above.

Delay *0...127*

The **Delay** parameter works differently depending on the setting of the **Fade** parameter in the LFO edit menu:

- When **Fade** is set to *+00...+63*, the LFO signal output is zero for the time set with the **Delay** parameter. After this time, the LFO is faded in and then runs with full magnitude.
- When **Fade** is set to *-64...-01*, the LFO runs with full magnitude for the time set with the **Delay** parameter. After this time, the LFO is faded out to zero.

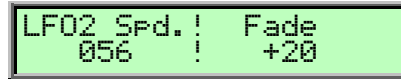

LFO2 Spd. – LFO 2 Speed *0...127*

Determines the frequency of LFO 2. For the sake of completeness this parameter can be also found here in the LFO Edit Menu. See "LFO 1 Speed" above.

Fade *out 64...in 63*

Controls the speed with which the LFO is faded in or out. With this parameter you can create slowly rising or falling modulations that might create interest when routed to pitch or volume.

i Please see the **LFO Delay** parameter on page 116 for further information.

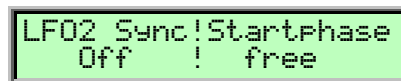

LFO2 Sync *On / Off*

For the sake of completeness this parameter can be also found in the LFO Edit Menu. See "LFO 1 Sync" above.

Phase *free, 000°...360°*

Controls the initial phase of the LFO when a new note is started. *Free* means that the LFO isn't restarted on a new note but runs freely while other values set the LFO phase to the respective offset in degrees.



LFO2 Clk - LFO 2 Clocked *Off / On*

When **LFO2 Clk** is activated, the LFO is synced to the global **Tempo** of the microQ. The **LFO Speed** setting for LFO 2 is changed to offer musically meaningful values.

i Please read the section "The Tempo" on page 124 for further information.

Keytrack *-200%...+196%*

Determines how much the speed of the LFO depends on the MIDI note number. The reference note for Keytrack is E3, note number 64. For positive settings, the LFO speeds up on notes above the reference note, for negative settings the LFO slows down when higher notes are played and vice

versa. A setting of +100% corresponds to a 1:1 scale, e.g. when the keyboard is played an octave higher, the LFO speed is doubled.

```
LF03 Shp.! Delay
Sine ! 000
```

LF03 Shp. – LFO 3 Shape *Sine / Triangle / Square / Saw / Random / S & H*

Determines the shape of LFO 3. For the sake of completeness this parameter can be also found here in the LFO Edit Menu. See "LFO 1 Shape" above.

Delay *0...127*

The **Delay** parameter works in different ways depending on the setting of the **Fade** parameter in the LFO edit menu:

- When **Fade** is set to +00...+63, the LFO signal output is zero for the time set with the **Delay** parameter. After this time, the LFO is faded in and then runs with full magnitude.
- When **Fade** is set to -64...-01, the LFO runs with full magnitude for the time set with the **Delay** parameter. After this time, the LFO is faded out to zero.

```
LF03 Spd.! Fade
056 ! +20
```

LF03 Spd. – LFO 3 Speed *0...127*

Determines the frequency of LFO 3. For the sake of completeness this parameter can be also found here in the LFO Edit Menu. See "LFO 1 Speed" above.

Fade *out 64...in 63*

Controls the speed with which the LFO is faded in or out. With this parameter you can create slowly rising or falling modulations that might create interest when routed to pitch or volume.

i Please see the **LF0 Delay** parameter on page 116 for further information.

```
LF03 Sync!StartPhase
Off ! free
```

LF0 3 Sync *On / Off*

For the sake of completeness this parameter can be also found in the LFO Edit Menu. See "LFO 1 Sync" above.

Phase *free, 000°...360°*

Controls the initial phase of the LFO when a new note is started. *Free* means that the LFO isn't restarted on a new note but runs freely while other values set the LFO phase to the respective offset in degrees.

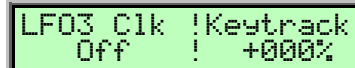

LFO3 C1k !Keytrack
Off ! +000%

LFO3 C1k - LFO 3 Clocked *Off / On*

When **LFO1 C1k** is activated, the LFO is synced to the global **Tempo** of the microQ. The **LFO Speed** setting for LFO 3 is changed to offer musically meaningful values.



Please read the section "The Tempo" on page 124 for further information.

Keytrack*-200%...+196%*

Determines how much the speed of the LFO depends on the MIDI note number. The reference note for Keytrack is E3, note number 64. For positive settings, the LFO speeds up on notes above the reference note, for negative settings the LFO slows down when higher notes are played and vice versa. A setting of +100% corresponds to a 1:1 scale, e.g. when the keyboard is played an octave higher, the LFO speed is doubled.

Mod Matrix Section

A modulation can be described as a signal-generating unit's influence upon a sound parameter. The terms used in this context are "source" and "destination". The microQ offers 16 independent modulation assignments (slots) each with individual settings of source, destination and amount. The Modulation Matrix (Mod Matrix) is the key of the power of each Waldorf synthesizer, so start experimenting with it *right now*.

The following picture of the microQ's parameter matrix shows the Mod Matrix section:



The Modulation Matrix is split into two basic kinds of modulations:

Fast Modulation Matrix (M1F...M8F)

These slots feature a high internal update rate, intended to be used for modulations that require very fast calculations.

Standard Modulation Matrix (M1S...M8S)

These slots are calculated at normal speed, which is still fast enough for most modulation purposes, e.g. when dealing with the modulation wheel or velocity. The Standard Modulation Matrix slots offer an extended set of modulation sources and destinations compared with the Fast Modulation Matrix.



For in-depth information about modulation speed and tables of the various available sources and destinations, read the chapter "Modulation Speed Levels" on page 46.

Mod Matrix Parameter Controls

All parameters related to the Modulation Matrix can be edited with the endless dials of the Mod Matrix section.

Select

Select the respective slots **M1F...M8F** or **M1S...M8S**.

Source

see Tables "Fast Modulation Sources" and "Standard Modulation Sources"

Defines the modulation source.



Please take into consideration that the number of modulation sources available depends on the type of modulation slot you're using.

Amount

-64...+63

Determines the amount of modulation applied to the destination. Since the modulation is in fact a multiplication of the source signal and this parameter, the resulting amplitude depends on the type of modulation source you select:

- For the so-called unipolar modulation sources, the resulting amplitude lies within the range of 0...+1, if Amount is positive or 0...-1, if Amount is negative. These sources are: all envelopes,

all MIDI controllers including Modwheel, Foot control etc., Velocity, Release Velocity, Aftertouch (Pressure) and Polyphonic Pressure.

- For the so-called bipolar modulation sources, the resulting amplitude lies within the range of -1...0...+1. These sources are: all LFOs, Keytrack, Pitchbend and the Modifiers.

Destination *see Tables “Fast Modulation Matrix Destinations” and “Standard Modulation Matrix Destinations”*

Defines the modulation destination.

 Please take into consideration that the number of modulation sources available depends on the type of modulation slot you’re using.

Mod Matrix Edit Menu

The following settings can be accessed via the Mod Matrix Edit Menu. To activate, please press the **Edit** button for the Mod Matrix Parameter Level.

```
M1F Src.
LFO1
```

```
M1F Dst. ! Amount
Pitch ! +10
```

You will find all “slots” reiterated here. The first page for each slot displays the Modulation source, the second page the Modulation destination as well as the amount level. The first 16 pages deal with the Fast Modulations, the next 16 pages with the Standard Modulations.

 You can set up Modulations either with the Parameter Matrix or the Mod Matrix Edit Menu. The result will be the same.

Following the Modulation Matrix parameters you will find the Modifier Matrix:

Modifier Matrix

Modifiers allow you to apply mathematical functions on modulation signals. Depending on the function type selected, calculation will affect two source signals or a source signal and a constant parameter. You can use up to four independent modifier units. The result of each operation is not directly audible, but is used as input source for the Standard Modulation Matrix. Moreover, you can use it as source for yet another modifying process.

The parameter for the modifiers can be found after the pages of the Mod Matrix Edit Menu for the Modulation slots. Please select these pages with the **Page Dial**.

```
Md1 Src1 !Source 2
LFO1 !constant
```

Md1 Src - Source #1 *see Table “Standard Modulation Sources”*

Selects the first source signal used for the calculation.

Source #2 *see Table “Standard Modulation Sources”*

Selects the second source signal when two sources are required for the calculation. See description of modifier functions for further details. The possible settings are the same as for **Source #1** with one exception: “Off” is replaced by “constant” meaning that the calculation is performed with a constant value that you can set up with the **Constant** parameter.



Md1 Oper. - Operation *see Table “Modifier functions”*

Determines which kind of operation will be performed on the selected input sources. The following types are available:

Setting	Description
+	Addition
-	Subtraction
*	Multiplication
XOR	Exclusive OR function
OR	OR function
AND	AND function
min	Minimum value
MAX	Maximum value

Table 14: Modifier functions

The result of a modifier operation always lies within the range - max...0...+max. When it is assigned to a parameter in the Modulation Matrix, it is scaled to the range of the selected parameter.

The following paragraph describes the function and the result of each modifier function in detail:

- + Returns the sum of **Source #1** and **Source #2**.
- - Returns the difference of **Source #1** and **Source #2**.
- * Returns the product of **Source #1** and **Source #2**.
- AND Returns the binary and operation of **Source #1** and **Source #2**.
- OR Returns the binary or operation of **Source #1** and **Source #2**.
- XOR Returns the binary exclusive-or operation of **Source #1** and **Source #2**.
- min Returns the minimum value of either **Source #1** or **Source #2**. If **Source #1** is smaller than **Source #2**, the value of **Source #1** is returned and vice versa.
- MAX Returns the maximum value of either **Source #1** or **Source #2**. If **Source #1** is greater than **Source #2**, the value of **Source #1** is returned and vice versa.

Constant *-64...+63*

Defines a value for modifier functions that require a constant parameter. See the **Operation** parameter described above for further details.

 The three other Modifiers **Md2**, **Md3** and **Md4**, are available to you on the remaining pages of this menu. They can be edited in the same way as **Md1**.

The Tempo

Tempo 40...300

The **Tempo** control is one of the most important parameters in all operation modes of the microQ. It controls the tempo of the Arpeggiator, some Effect types and the LFOs for which **Clocked** is activated.

In Multi Mode, **Tempo** controls the overall tempo of the current Multi, affecting all Sounds that are used in its Instruments.

These parameters are affected by **Tempo**:

- **LFO 1...3 Speed**, when the respective **Clocked** parameter is activated
- Effect type **Delay**, when its **Tempo** parameter is set to *Internal*
- The Arpeggiator

Clock *Internal / Send / Auto / Auto-Thru*

Tempo goes hand in hand with the **Clock** parameter in the **Global** menu. It determines how the microQ reacts to incoming MIDI Clock messages and whether it sends them. Depending on the setting of **Clock**, the actual sound tempo is set as follows:

- *Internal* means that the microQ doesn't react to incoming MIDI Clock nor does it send MIDI Clock. The microQ only syncs to its own tempo base that is set by **Tempo**.
- *Send* means that the microQ doesn't react to incoming MIDI Clock but sends it as MIDI Clock messages through its MIDI Out. Use this setting when you want to sync other devices to the microQ's **Tempo** setting but want the microQ to disregard sync from any other device.
- *Auto* means that the microQ automatically syncs to incoming MIDI Clock if it is sent to it by an external device like a sequencer or drum machine. If there is no MIDI Clock present, the microQ generates its internal tempo base and sends it as MIDI Clock messages through its MIDI Out. **This is the recommended setting that works in almost all situations.**

Now, how does *Auto* really work? When you select a Sound or a Multi, the programmed tempo is used as long as no MIDI Clock is received. As soon as the microQ receives MIDI Clock, the **Tempo** parameter is changed to match the incoming MIDI Clock. This tempo is still valid when no MIDI Clock is no longer received. You can now change the Tempo manually starting from the calculated value or perform the **Recall** function for the Sound or Multi to get back to the stored tempo.

- *Auto-Thru* means that the microQ automatically syncs to incoming MIDI Clock and always sends out MIDI Clock, no matter if it received it or if it generated the tempo base itself. This setting is only useful for special setups where you need to control a device through the microQ's MIDI Out including sync, e.g., when you use the microQ in a live performance in which the microQ itself is synced to a sequencer but needs to send MIDI Clock to a hardware sequencer, too.



The recommended setting for Clock is Auto. This setting works in almost all situations. Please read the description above for a detailed explanation of it.

Drum Map

The microQ allows you to create Drum Maps, which represent an array of 32 sounds mapped over the keyboard. You can use them to trigger drum or effect sounds that you don't need to play polyphonically with different pitches. Each Multi program can hold one Drum Map which, combined with the 16 part Multi mode of the microQ, gives you $15 + 32 = 47$ different sounds simultaneously.

To select a Drum Map, refer to the chapter "Selecting Programs" on page 28. Drum Maps are stored in Bank D. After you've selected a Drum Map, you can edit its parameters in the Sound menu accessed by pressing the **Sound** button in the **Master Section**.

Drum Map Sound Menu

Selecting a Drum Map entry for editing is done by simply playing a key on your keyboard. The upper left corner of the display shows the Drum Sound you are about to edit like this:

```
#01 Q BD 4      jh
C      |      C045
```

With the **Page Dial** you can select the various pages for the displayed Drum Sound. When you reach the last page, the microQ automatically jumps to the next Drum Sound's first page and vice versa.

```
#02 TR66 Sidestk WMF
C      |      C070
```

Sound Bank and Number *A...C 001...100*

Each Drum Map entry points to one Sound in memory. The display shows the Sound name in the upper row and the Sound bank and number in the lower row as follows:

☞ **To select a Sound for an Instrument:**

- Use the **left display dial** to select *Bank A...C* from which the Sound program is taken.
- Use the **right display dial** to select the Sound program *001...100*.

```
#01 Pan | Output
center |Main Out
```

Pan *L64...center...R63*

Controls the stereo position of the selected Drum Map entry.

Output *Main Out / Sub Out 1 / Sub Out 2*

Sets the audio output for the selected Drum Map entry.

```
#01 Key |Transpose
C#1   |  +00
```

Key *C-2...G8*

Defines the lowest key for the selected Drum Map entry. A Drum Map entry can span over more than one note. I.e., when you set entry #01 to C1 and entry #02 to E1, entry #01 can be played from C1 to D#1.

i Be careful with this parameter. As soon as you change it to another note, you have to press this new note to call up the entry again. This sounds obvious, but it might cause confusion.

Transpose *-60...+60*

Controls the transposition offset of the selected Drum Map entry. In the Drum Map, Sound programs still keep their various keytrack settings, so melodic sounds still play the pitch of the notes they are mapped to. With Transpose, you can change the keytrack offset to the tuning you like.

i Please note that this parameter shifts the incoming note. When you've set the oscillators of the selected Sound to ignore keytrack (**O1...O3 Keytrack 0%**), this parameter also has no effect on the pitch of the oscillators.



Volume *0...127*

Sets the maximum output volume of the selected Drum Map entry.

Global Parameters

Global parameters are settings that affect the microQ's general response. They are valid for all programs but might be overridden by other more specific settings. Global parameters are stored automatically when you modify them, so you are not required to save them manually.



The Global menu of the microQ Keyboard contains additional parameters.

Global Menu

All Global parameters are located in the Global Menu. Press the Master section's **Global** button and select the various pages with the **Page Dial** or by pressing the **Global** button again. The menu parameters are changed with the corresponding knobs below the display.

```
GlobalChn|SysEx ID
  01      !000 (00)
```

Global Chn - Global MIDI Channel *omni / 1...16*

Sets the basic send and receive channel for the microQ. This setting is valid for all Sound programs and for Instruments of a Multi program whose Channel parameter is set to *global*. If *omni* is selected, the microQ sends on channel 1 and receives on all channels.



Please use *omni* only for test purposes if you wish to check the basic MIDI send and receive functionality. As soon as you know that the microQ receives MIDI properly, set Global MIDI Channel to any other value than *omni*.

Sysex ID *0...126*

Defines the device identification number for system exclusive data transmission. The number in brackets shows the current ID in hexadecimal number format.

System Exclusive data contains no MIDI channel information so this ID is used to distinguish between several microQs, if you have more than one Waldorf microQ in your setup.

Transmission will only be executed successfully if the sender and receiver are set to the same ID. ID 127 is a so-called broadcast ID that addresses all connected microQs. The microQ can receive Sysex data broadcast from other devices, but cannot send it itself. This function is limited to special computer software.



Operating System upgrades are stored with a Device ID of 127, so you don't need to change the **Sysex ID** on your microQ when you want to upgrade it to a newer OS.



If you have only one microQ, leave Sysex ID on 0. There is no need at all to change this setting to any other value.



After you have bought your 128th microQ, please contact Waldorf Electronics. You will receive a personal device number that authorizes you to have dinner with our Managing Director.

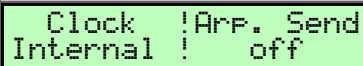

```
Clock !Arp. Send
Internal ! off
```

Clock*Internal / Send / Auto / Auto-Thru*

Please read the chapter "The Tempo" on page 124 for in-depth information about the **Clock** parameter.

Arpeggiator Send*Off / On*

Determines whether Arpeggiator notes are sent by the microQ over MIDI.

- If *Off* is selected, no notes are sent.
- If *On* is selected, all notes are sent over MIDI Out (whenever the Arpeggiator is active).

Local (microQ Keyboard only)*Off / On*

```
Local
On
```

Determines, if the keyboard, pitch bend and modulation wheel are coupled to the internal tone generation. When set to *On*, the microQ Keyboard sends all note information and controller data to the tone generation and eventually over MIDI. When set to *Off*, the microQ Keyboard doesn't send any note information to its tone generation but works similar to a MIDI master keyboard.



This is one of the most important parameters when working in a MIDI setup. As soon as you connect the microQ Keyboard to a sequencer by MIDI, you should set **Local** to *Off*. The MIDI data flow then is as follows: when you play a note on the microQ Keyboard, it is sent to the sequencer. The sequencer eventually maps the note to a different MIDI channel and sends it out through a specific MIDI port. With this method you can control your whole MIDI setup and also play the microQ's tone generation if you set the sequencer to send MIDI notes to the microQ.

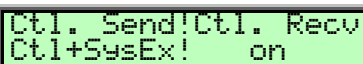

```
Ctl. Send!Ctl. Recv
Ctl+SysEx! on
```

Controller Send*Off / Ctl / SysEx / Ctl+SysEx*

Determines how Real-Time Sound Parameter Changes are sent by the microQ over MIDI.

- If *Off* is selected, no data is sent.
- If *Ctl* is selected, only controller messages are sent. Parameters without a dedicated controller are not sent at all.
- If *SysEx* is selected, all Sound parameters are sent as system exclusive messages. This has the advantage that the parameter change is not channel based but instrument based, which can prevent unwanted parameter changes in layered sounds. The disadvantage is that a larger amount of data is transferred.
- If *Ctl+SysEx* is selected, all Sound parameters with a dedicated controller assignment are sent as controller messages. All other Sound parameters are sent as system exclusive messages. **This is the recommended setting.**

i Set **Controller Send** to *Ctl+SysEx* during normal operation. Only switch it to *SysEx* when you work with layered Multis, or to *Ctl* if your sequencer can't work with system exclusive data anyway.

Controller Recv *Off / On*

Determines whether Real-Time Sound Parameter Changes are received over MIDI by the microQ.

- If *Off* is selected, no Sound Parameter Changes are received.
- If *On* is selected, all Sound Parameter Changes are received, whether or not they were sent as controller or system exclusive messages.

i Set **Controller Recv** to *On* during normal operation. You should only set it to *Off* for diagnostic purposes.

Ctrl W...Ctrl Z *0...120*

```
Ctrl W | Ctrl X
000 (00) 1000 (00)
```

```
Ctrl Y | Ctrl Z
000 (00) 1000 (00)
```

These parameters are used to define arbitrary MIDI Continuous Controllers as modulation sources for Sounds. You can setup four Controls, W, X, Y and Z, for this purpose. Each value represents a MIDI Continuous Controller number that is used when you assign its parameter as modulation source in the Modifiers or the Modulation Matrix. The highest possible Controller number is 120 because all higher numbers are reserved for non-real-time purposes.

i The most important Sound parameters of the microQ can be controlled by MIDI Continuous Controller messages. If you set one of the Ctrl W...Ctrl Z to a Controller that is also used for a Sound parameter, the microQ disables this Controller as Sound parameter Controller and uses it exclusively for one of the Ctrl W...Ctrl Z. This is an important issue when you send Sound parameter changes by tweaking parameters on the front panel. The Sound parameter is sent out as Controller but can't be received as long as you don't change Ctrl W...Ctrl Z to other MIDI Continuous Controller messages.

```
Rx PrgChg!Tx PrgChg
off ! off
```

Rx PrgChange *off / Number / Nmb.+Bank*

Determines how incoming Midi Program and Bank Changes will be handled.

- Incoming program and bank changes will be ignored if *Off* is selected.
- If *Number* is selected, the microQ only reacts to incoming program change commands. Bank change messages will be ignored. This setting can be used in case you wish to work with only one sound bank.
- With *Nmb.+Bank* being active the microQ reacts to program as well as bank changes. This setting is recommended for normal use.

 When filter is set to *Number*, in multi mode only the multi program itself can be changed, not the instrument sounds.

Tx PrgChange

off / Number / Nmb.+Bank

Determines the Midi Program and Bank Changes that the microQ will send through its Midi Out ports.

- If *Off* is selected, no program and bank change commands will be send.
- When set to *Number* the microQ only sends program change messages. Bank change messages won't be send.
- The setting *Nmb.+Bank* will cause the microQ to send program as well as bank change messages when selecting programs.

```
Tuning | Transpose
440Hz | +00
```

Tuning

430...450 Hz

Controls the microQ's overall pitch in Hertz. The value specified here is the reference pitch for MIDI note A3. The default setting is 440Hz, which is commonly used by most instruments.

 **You should only change this setting if you really know what you're doing. You will have to adjust all your other instruments, too. Don't forget to set it back again!**

Transpose

-12...+12

Allows a global pitch transposition for the tone generator. Incoming MIDI notes are shifted by the number of semitones.

FX2 (glb) link - FX2 global link

none / Inst. 1...4

```
FX2 (glb) link
Inst.1
```

The microQ has 5 DSP effect blocks. The effect blocks 1...4 are always coupled to instruments 1...4 (in single and multi mode). Effect block 5 is called **FX2**. You can share **FX2** between the first 4 instruments if you use the settings *Inst. 1...4*. In this case **FX2** is always stored and recalled for every sound on the coupled instrument.

If you choose the setting "*none*" **FX2** is stored and recalled globally.

 Normally the **FX2 (glb) link** parameter should be set to *Inst.1*, in this case the FX2 will be stored & recalled for Inst. 1 changes.

Input Gain

1...4

```
Input Gain
2
```

Sensitivity of the Stereo External In . The different Input Gain settings attenuate or amplify the input signal as follows:

Input Gain Setting	Gain	max. Input Level	Remarks
1	-8dB	+14dBm	For very high level signals.
2	0dB	+6dBm	Studio level signals. This is the recommended setting.
3	+10dB	-4dBm	Line level signals.
4	+29dB	-23dBm	Low level signals such as microphone, guitar etc.

Table 15: Input Gain Settings



Connecting a microphone or guitar directly to the microQ is not recommended. Low signal level instruments should be amplified by a special pre-amplifier before they are routed to the microQ's External In.

Mix In to (not available for microQ lite) *Main out/Sub out 1/Sub out 2/Inst.1...4 FX/FX2 wet*

```
Mix In to!MixLevel
Inst.1 FX! 082
```

This parameter allows you to send an external audio signal directly into the microQ's effect section without the need of a note trigger.

- *Main out* will route an external signal directly to the microQ's Main Out.
- *Sub out 1* will route an external signal directly to the microQ's Sub Out 1.
- *Sub out 2* will route an external signal directly to the microQ's Sub Out 2.
- *Inst.1 FX...Inst.4 FX* will route an external signal into the effect sections of instruments 1...4 and to the corresponding audio output.
- *FX2 wet* will route an external signal into the effect section of slot 2.

Mix Level (not available for microQ lite) *0...127*

Determines the volume of the audio signal selected in the **Mix In to** menu.

On Velocity Curve (microQ Keyboard only) *exp 2 / exp 1 / linear / log 1 / log 2 / fix 32...127*

```
On Velocity Curve
exp 1
```

Sets the curve that is used for Note On Velocities when played on the keyboard. It changes the velocity behaviour of the internal tone generation and the outgoing MIDI Note messages. It doesn't affect incoming MIDI Note messages.

The following picture shows the response of the different curves:

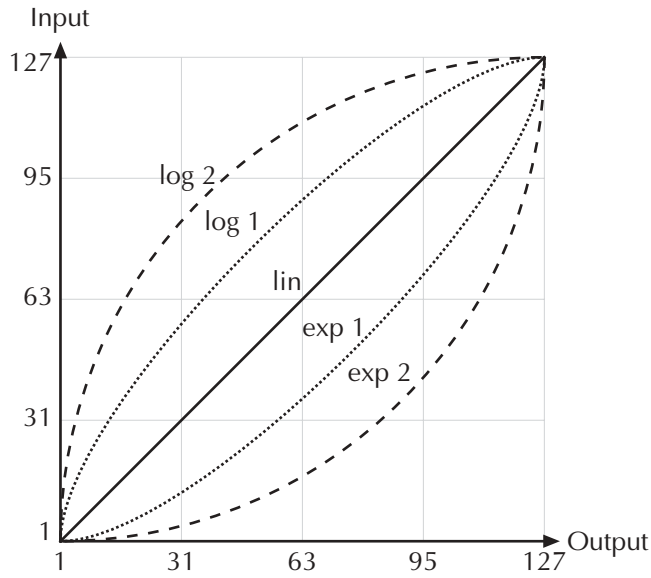

Response of the different Curve settings

The 4 *fix* values only use its corresponding velocity setting.

i For a standard keyboard velocity response, you should set **On Velocity Curve** to *linear* or *exp 1*. Other curves might be applicable under special circumstances only.

Rel. Velocity Curve (microQ Keyboard only) *Off / exp 2 / exp 1 / linear / log 1 / log 2 / fix 32...127*

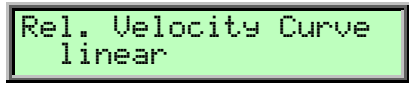

Sets the curve that is used for release velocities when played on the keyboard. It changes the release velocity behaviour of the internal tone generation and the outgoing MIDI Note Off messages. It doesn't affect incoming MIDI Note Off messages.

The various curves are identical to the ones shown under "**On Velocity Curve**".

i For a standard keyboard release velocity response, you should set **Rel. Velocity Curve** to *linear* or *log 1*. Other curves might be applicable under special circumstances only.

Pressure Curve (microQ Keyboard only) *exp 2 / exp 1 / linear / log 1 / log 2*



Sets the curve that is used for aftertouch when played on the keyboard. It changes the aftertouch behaviour of the internal tone generation and the outgoing MIDI Aftertouch messages. It doesn't affect incoming MIDI Aftertouch messages.

The various curves are identical to the ones shown under "**On Velocity Curve**".

i For a standard keyboard aftertouch response, you should set **Pressure Curve** to *linear* or *exp 1*. Other curves might be applicable under special circumstances only.

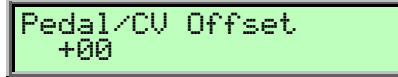
Pedal/CV Offset (microQ Keyboard only) -64...+63

 A screenshot of a digital display showing the text "Pedal/CV Offset" on the top line and "+00" on the bottom line. The display has a green background and a black border.

Sets the initial gain for Control Pedal/CV that is used when the pedal is at its **minimum** position. To find out which value is suited for the Control Pedal/CV you want to use, do the following:

 **To adjust Pedal/CV Offset:**

1. Set **Pedal/CV Ctrl.** to *Control W*.
2. Set an empty Standard Modulation Matrix slot of the current sound as follows: **Source:** *Control W*, **Destination:** *Pitch*, **Amount:** +63.
3. Move the Pedal to its minimum position or make sure that the CV is at its minimum voltage.
4. Adjust **Pedal/CV Offset** until the pitch is the same no matter if the **Amount** in the Matrix slot is set to +00 or +63.

Pedal/CV Gain (microQ Keyboard only) 0...127

 A screenshot of a digital display showing the text "Pedal/CV Gain" on the top line and "127" on the bottom line. The display has a green background and a black border.

Sets the maximum gain for Control Pedal/CV that is used when the pedal is at its **maximum** position. To find out which value is suited for the Control Pedal/CV you want to use, do the following:

 **To adjust Pedal/CV Gain:**

1. Perform the steps under **Pedal/CV Offset**.
2. Set the Matrix slot **Source** to *MAXIMUM* and adjust **Amount** so that you can just hear the sound with a very high pitch.
3. Move the Pedal to its maximum position or make sure that the CV is at its maximum voltage.
4. Adjust **Pedal/CV Gain** until the pitch is the same no matter if you set **Source** to *MAXIMUM* or *Control W*.

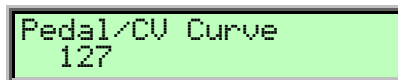
Pedal/CV Curve (microQ Keyboard only) 0...127

 A screenshot of a digital display showing the text "Pedal/CV Curve" on the top line and "127" on the bottom line. The display has a green background and a black border.

Sets the curve that is used for the Control Pedal/CV. It changes the behaviour of the internal tone generation and the outgoing MIDI messages. It doesn't affect incoming MIDI messages.

You can change the settings from 0 to 127 continuously.

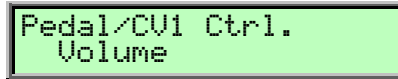
 Depending on the Control Pedal/CV you use, different values might apply. Please try to find out the best setting yourself.

Pedal/CV Ctrl. (microQ Keyboard only) *Off/Volume/Control W...Z/Filter 1 Cutoff/Filter 2 Cutoff*

Pedal/CV1 Ctrl.
Volume

Sets the controller that is used for the Control Pedal/CV. The respective controller is sent to the internal tone generation and over MIDI. The following settings are available:

- If *Off* is selected, no controller is sent.
- If *Volume* is selected, the volume controller #7 is sent to the internal tone generation and over MIDI.
- If *Control W...Z* is selected, the respective controller as set in the Control W...Z setting page is sent to the internal tone generation and over MIDI.
- If *Filter 1 Cutoff* is selected, the filter cutoff controller for Filter 1 is sent to the internal tone generation and over MIDI.
- If *Filter 2 Cutoff* is selected, the filter cutoff controller for Filter 2 is sent to the internal tone generation and over MIDI.

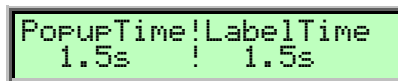

PopupTime!LabelTime
1.5s ! 1.5s

PopupTime*0.1s...15.5s*

Here you can adjust for how long a time the name and value are shown in the upper right corner of the display when you perform any parameter edits.

 As a newcomer to the microQ you should choose a higher setting, around 5-10 sec. After you have had more experience with the microQ, you might lower this value to around 1.5 sec.

LabelTime*0.1s...15.5s*

Here you can adjust for how long a time the menu page name is shown in the upper right corner of the display when you activate any edit menus.

 As a newcomer to the microQ you should choose a higher setting, around 5-10 sec. After you have had more experience with the microQ, you might lower this value to around 1.5 sec.

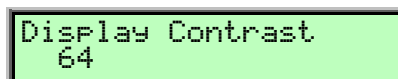
Display Contrast*0...127*

Display Contrast
64

Sets the display contrast. If you accidentally set this parameter to 0, you may not be able to read the display any more. If you then switch the microQ off and back on later, it might appear that the microQ is defective. If this should ever happen, open this manual and proceed as follows:

 **To restore the Display Contrast to a normal setting:**

1. Power the microQ up.
2. Press **Global**.
3. Turn the **Page Dial** clockwise several times and then exactly 4 clicks counterclockwise.

4. Turn the **left display dial** clockwise until you can read the display. Now the display should work as usual. If not, turn the **Page Dial** counterclockwise for a short while and repeat the procedure from step 3.

Operating System (OS) page

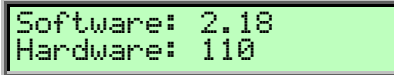

```
Software: 2.18
Hardware: 110
```

This menu page shows the latest Operating system (SW) and the hardware version (HW) of your microQ. For more information about updating your microQ please read "Updating the System software" on page 132.

Board/Serial Number page

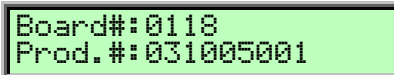

```
Board#:0118
Prod.#:031005001
```

This menu page shows you the Board and Serial number of your microQ.

Upgrade-Code (only microQ lite)

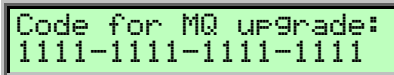

```
Code for MQ upgrade:
1111-1111-1111-1111
```

On this menu page the upgrade code for the microQ lite can be found. It is used when making an upgrade to a fullrange microQ. For more information about prices and handling please refer to our website: <http://www.waldorf-music.com>



On the menu pages that follow you will find other important information. Please read and follow these instructions.

Utility menu

Aside from the different Midi Dump Options, the Utility Menu contains further helpful functions.

You can access the Utility Menu by pressing **Shift + Global/Utility**. In the display a page for selecting the desired function will appear:



```
DUMP Sound A001
[Utility]
```

Turn the page dial until you reach the appropriate function.

MIDI Dump functions

Please read the chapter "Sending System Exclusive Data" on page 140.

Init Sound



```
Init Sound A001
[Utility]
```

The microQ provides a special function for setting all parameters of a Sound program to initial values. You can use it to create a new program from scratch.

 **This is how you initialize a Sound program:**

- Select the designated Sound program.
- Press **Shift + Global/Utility** and choose the option **Init Sound**.
- Press **Shift + Global/Utility** again to activate the function.

The selected program is now initialized.

 When you initialize a program, all action takes place inside an edit buffer. Therefore no data will be lost until you store the program.

Init Multi

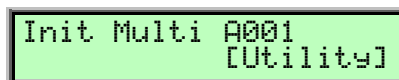

```
Init Multi A001
[Utility]
```

The microQ provides a special function for setting all parameters of a Multi program to initial values. You can use it to create a new Multi program from scratch. This function is only available in Multi mode.

 **This is how you initialize a Multi program:**

- Select the designated Multi program.
- Press **Shift + Global/Utility** and choose the option **Init Multi**.
- Press **Shift + Global/Utility** again to activate the function.

The selected Multi program is now initialized.

 When you initialize a Multi program, all action takes place inside an edit buffer. Therefore no data will be lost until you store the program.

Init Drums

```
Init Drums D01
[Utility]
```

The microQ provides a special function for setting all parameters of a Drum Map to initial values. You can use it to create a new Drum Map from scratch. This function is only available if a Drum Map is selected.



This is how you initialize a Drum Map:

- Select the designated Drum Map.
- Press **Shift + Global/Utility** and choose the option **Init Drums**.
- Press **Shift + Global/Utility** again to activate the function.

The selected Drum Map is now initialized.



When you initialize a Drum Map, all action takes place inside an edit buffer. Therefore no data will be lost until you store the program.

Random Sound

```
Random Sound A001
[Utility]
```

This function initializes all parameters of a Sound Program with random values.



This is how you randomize a program:

- Select the appropriated Sound program.
- Press **Shift + Global/Utility** and choose the option **Random Sound**.
- Press **Shift + Global/Utility** again to activate the function.

The selected program is now randomized.



When you randomize a program, all action takes place inside an edit buffer. Therefore no data will be lost until you store the program.



Use **Random Sound** as much as possible. This is how most of the microQ's preset sounds are programmed ;-)

MIDI Control

This chapter describes the MIDI functions of the Waldorf microQ.

Channel Based MIDI Messages

In Single Mode, the microQ receives and sends (microQ keyboard) channel based MIDI messages like Notes, Aftertouch, Pitchbend and Controllers on the selected **Global MIDI Channel**. If it is set to *omni*, the microQ sends channel based MIDI messages on channel 1 but receives them on any channel. All received channel based MIDI messages are played back by the active Instrument or Layer.

In Multi Mode, the microQ can send and receive on all 16 MIDI Channels at once, depending on the Instrument settings of the current Multi program.

Program Change Messages

MicroQ Sound and Multi programs can be selected by MIDI Program Change messages together with MIDI Bank Select messages. As the microQ contains 100 programs in each bank, it recognizes the program numbers 1...100 (on zero-based MIDI senders, this means 0...99). The Bank Select LSB message (Controller #32) is used to switch between different banks:

- Bank 0 contains Sound Programs A001...A100.
- Bank 1 contains Sound Programs B001...B100.
- Bank 2 contains Sound Programs C001...C100.
- Bank 3 contains Drum Maps D01...20

In Multimode, the microQ changes the Sound on individual Instruments.



Please take into consideration that only 20 Drum Maps are available. Program Changes with higher values than 20 will be ignored.

Note On and Note Off Messages

The microQ receives Note On and Note Off Messages in the entire MIDI Note Number range with Velocity and Release Velocity. The microQ keyboard also sends Note On and Note Off Messages. Note On with Velocity 0 (simple note off) is evaluated as Note Off with Release Velocity 64.

Aftertouch Messages

The microQ receives monophonic Aftertouch messages. The microQ evaluates incoming Aftertouch messages as "Pressure" modulation source. The microQ keyboard also sends Aftertouch messages.

Poly Pressure Messages

The microQ receives Poly Pressure Messages but can't send them. Poly Pressure Messages are evaluated as "Poly Prs." modulation source.

Pitchbend Messages

The microQ receives Pitchbend Messages with a resolution of 14 bits. Pitchbend ranges are controlled by the **BendRg** parameters in the Oscillator Edit menu. Pitchbend Messages can also be used as "Pitchbend" modulation source. The microQ keyboard also sends Pitchbend Messages.

Modulation Wheel

The microQ receives Modulation Wheel MSB Messages and evaluates them as “Modwheel” abbreviated as “MW” modulation source. The microQ keyboard also sends Modulation Wheel MSB Messages.

Breath Control Messages

The microQ receives Breath Control MSB Messages and evaluates them as “BreathCtr” modulation source.

Foot Controller Messages

The microQ receives Foot Control MSB Messages and evaluates them as “Foot Ctr” modulation source.

Channel Volume Messages

The microQ receives Channel Volume Messages (Controller #7) and scales the output of the respective Sound to that value. The maximum Sound volume depends on the settings in the Sound, Instrument and Multi. Channel Volume changes the volume relative to these settings.

Pan Messages

The microQ receives Pan Messages (Controller #10) and balances the two Filter outputs according to this value. A value of 64 means that the Filter Pan settings are kept as they are while smaller values weigh the signal towards the left output and larger values weigh the signal towards the right output.

Sustain Pedal Messages

The microQ receives Sustain Pedal Messages (Controller #64) and evaluates them as follows: if a value greater or equal than 64 is received, the “Key Pressed” envelope phases of all voices of the respective MIDI channel are played. If a value smaller than 64 is received, the “Key Off” envelope phases are played. Sustain Pedal Messages can also be used with the “Sust. Ctr” modulation source.

Sostenuto Pedal Messages

The microQ receives Sostenuto Pedal Messages (Controller #65) and evaluates them as follows: if a value greater or equal than 64 is received, the “Key Pressed” envelope phases of the currently playing voices of the respective MIDI channel are played. Voices that are played afterwards are not affected by the Sostenuto Pedal message. If a value smaller than 64 is received, the “Key Off” envelope phases of the affected voices are played.

All Notes Off Message

The microQ sends an All Notes Off Message to the internal tone generator and over MIDI on all channels when the **Power** button is pressed briefly.

When the microQ receives an All Notes Off Message, it forces the envelopes of all sounding voices to go into their release phases. Furthermore, Arpeggiators are stopped if they were running.

All Sound Off Message

The microQ sends an All Sound Off Message to the internal tone generator and over MIDI on all channels when the **Power** button is pressed until the power down countdown starts.

When the microQ receives an All Sound Off Message, it closes the amplifiers of all sounding voices and stops the output of all effects immediately.

Reset All Controllers Message

When the microQ receives a Reset All Controllers Message, it resets all controllers mentioned above, as well as Aftertouch, Poly Pressure and Pitchbend, to their default values (usually 0 except for Pan=64, Volume=127, Pitchbend=64).

Modifying / Editing Sounds over MIDI

Controllers as Modulation Sources

The controllers mentioned above are always used as modulation sources. The freely definable Control W...Z can also be used as modulation source. W...Z represent definable controller numbers 1...120. Use these controllers in the Modifiers and the Modulation Matrix.

Changing Sound Parameters with Controllers

Every Sound parameter that has a control in the parameter matrix is assigned to a MIDI Controller through which the parameter can be changed. If a parameter matrix control is turned, this change is sent with the appropriate controller number over MIDI. With this feature, you can easily record matrix parameter changes with a MIDI sequencer.

All controller messages are sent and received on the MIDI channel defined in the Global menu or, if in Multi Mode, on the MIDI channel selected for the corresponding Instrument.

Please read the sections "Controller Send" and "Controller Recv" in the chapter "Global Menu" on page 128 for further information.

Changing Sound Parameters with System Exclusive Data

All Sound parameters of the microQ can be controlled by system exclusive data.

Please read the sections "Controller Send" and "Controller Recv" in the chapter "Global Menu" on page 128 for further information.

System Exclusive Data Transmission

System Exclusive data transmission lets you send and receive the contents of the microQ's memory via MIDI (dump).

Sending System Exclusive Data

When you activate the send functions, the microQ sends the contents of its memory to the MIDI Out jack. Using a sequencer or a special sound editor program, you can record and archive this data.

 **To activate the dump function:**

1. Press **Shift + Global/Utility**. The display shows a page where you can select the dump type:

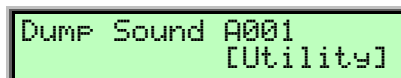

```
DUMP Sound A001
[Utility]
```

2. Use the page dial to select the desired dump function:

- If *Sound* is selected, the current Sound program will be sent. When used in Multimode, the Sound program of the currently selected instrument will be sent.
- If *Multi* is selected, the current Multi program will be sent. The Sound programs that made up the Multi are not sent. This function is only available in Multimode.
- If *Arrangement* is selected, the current Multi program with all its used Sound and Pattern programs is sent. Use this function to dump all settings of a Multi. This function is only available in Multimode.
- If *Drum Map* is selected, the current Drum Map will be sent. When used in Multimode, the Drum Map of the currently selected instrument will be sent.
- If *Global Data* is selected, all Global parameters are sent.
- If *all Sounds* is selected, all Sound programs of the microQ are sent.
- If *all Multis* is selected, all Multi programs of the microQ are sent.
- If *all Drum Maps* is selected, all Drum Maps of the microQ are sent.
- If **All** is selected, all Sounds, Multis, Drum Maps and the Global parameters are sent.

3. Press **Shift + Global/Utility** again to activate the dump.



Depending on the selected type, the dump may take some time. The microQ cannot be played during this time.

Receiving System Exclusive Data

You are not required to activate a special receive mode of the microQ in order to receive system exclusive data through MIDI. However, there are a few things you should check before you transmit system exclusive data to the microQ:

- Make sure none of the microQ's programs is in Edit mode. The edit buffers might be cleared or overridden depending on the type of dump that is sent to the microQ.
- Check out the parameter **SysEx ID**. Data transmission will only be executed successfully if the sender and receiver settings match.

As soon as the dump from the sending device is activated, the microQ will receive data and store these in its memory.

If a single Sound, Multi, Drum Map or Arrangement dump is received, it is temporarily stored in its respective edit buffer. If you want to keep such edits, you have to store them. Otherwise they are when you switch the microQ off.



The microQ is able to receive a sound dump from the Waldorf Q series via MIDI. According to that please refer to the chapter „System Exclusive Data Transmission“ in the Q manual.

Other Functions

Updating the System Software

The microQ has a service-friendly feature that makes it possible to update the system software without changing any parts.

All software updates come in the form of a standard MIDI file that can be read by every sequencer. The fastest way to get this file is by downloading it from our web site at:

<http://www.waldorf-music.com>

Please make sure to download the following files:

- os_xxxxx.mid (if it is newer than the one installed in your microQ)
- changelog.txt (always download this one, because it explains the latest changes)

i Possibly there can be a .zip file containing the new OS, new sounds and a manual addendum.

If you don't have Internet access, please ask your local dealer for a disk copy.

i The microQ keyboard and rack version are using the **same** operating system! It is possible to update a microQ lite, but there won't be no new features at all.

i The microQ series and the Q series **do not** using the same operating system!

 **To update the microQ's system software:**

1. Load the respective Standard MIDI File into your sequencer. Follow the instructions from your sequencer's manual.
2. The MIDI file consists of one single track with several sysex messages in it. Make sure that this track is assigned to the microQ so that it can receive the data.
3. Make sure that any Cycle or Loop mode is switched off. Also make sure that any Metronome clicks and MIDI Clock are switched off.
4. Start the sequencer playing the file, and send the track data to the microQ.
5. The microQ will display a message that informs you that the update is in progress:

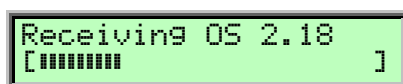

```
Receiving OS 2.18  
[##### ]
```

The progress line in the lower part of the display will show the amount of data already received.

6. After the file is received correctly, the microQ burns the update into its FLASH memory. This is shown by the following display:



⚠ Do not under any circumstances turn off the microQ while this step is in progress. A complete loss of data may occur and it will be impossible for you to make your machine work again!

7. Wait until the operation is completed. If updating was successful, the microQ will perform a system reset and start up.

If an error occurs in the process of updating, the microQ displays an error message, e.g.:



If this happens, try updating again. In some cases it can be helpful to adjust the sequencer tempo before playing the file so that the data events are sent more slowly.

If this message appears:



the file wasn't transmitted completely to the microQ or played back too slowly. Try to download the file from the Internet again.

i New functions in future OS will be documented in PDF files which are available on our website (<http://www.waldorf-music.com>) or at our ftp-server (<ftp://ftp.waldorf-gmbh.de/pub/waldorf/microq>).

Erasing internal data flash memory (not for microQ lite)

Holding down the **Global + Inst.3** buttons during power-up erases all data flash memory. All programs will be set to initial settings.

i We recommended to use this function before dumping a complete new sound set into your microQ.

⚠ Attention – By using this function you will lose all your stored programs. Please be sure backup your programs before.

Appendix

Tips & Tricks

- Noise as FM Source for an oscillator gives a colored noise output whose character can be changed with FM Amount, the oscillator waveform and the pitch of the oscillator.
- Use Envelope 3 or 4 to blend in one of the oscillators. E.g, if you need a small blip in the attack phase, just use a free oscillator and a short percussive envelope to create this effect. You can do that in the Modulation Matrix by setting the source to Env3 or Env4, the destination to Osc1, Osc2 or Osc3 level and setting up a positive amount. If this blip should be noisy, use FM with Noise as source for this oscillator to control the strength of the noise.
- For a classic “Filter Trigger” sound, you don’t need to actually use a filter. You can also use a sine oscillator that is pitch modulated by an envelope. This frees up the two filters and you can use them to perform other tasks, e.g. filtering noise for a snare drum sound or the like.
- Use the LFOs as FM Sources. With this technique, you get up to six oscillators frequency-modulating each other to create extremely complex timbres. Just keep in mind that the LFOs have a maximum speed of around 2500Hz and that they can produce aliasing side effects.
- Use the wavetables as FM sources. If a LFO modulates the wavetable at the same time, you will create *really* amazing sounds.
- For extremely wide sounds, you can do the following: Create a sound that uses only Filter 1 with the desired settings. Now set Routing to *serial* so that both filters are routed to the panning stages with equal volume. Set Filter 2 to a comb filter type with middle or low cutoff and no resonance. Now set the Pan parameters of the filters to opposite directions and you should get a very fat sound. You can create further movement by applying an LFO to the comb filter cutoff.
- The perfect place to read this user manual is your favorite bathroom. We recommend 5 pages per session!

Tips for better voice performance

The dynamic voice management of the microQ makes optimal use of its processing power. The following table shows you how to set up your microQ for the best voice performance.

Sound Parameter	Setup Tips
Oscillators	<ul style="list-style-type: none"> • Use oscillators in the order 1, 2, 3. • Turn off unused oscillators with the Shape parameter. Turning off oscillator 1 or 2 but leaving oscillator 3 turned on will not help. • Alt1/2 waveforms and the suboscillators use more processor power than other oscillator types.
Noise	<ul style="list-style-type: none"> • When you not use Noise turn the N/E Select F1/F2 feed parameter to an external setting.
Filter	<ul style="list-style-type: none"> • Use the filters in the order 1, 2. • Set unused filters <i>bypass</i> with the Type parameter. • Comb filters need more processor power as other filter types.
FM	<ul style="list-style-type: none"> • Turn off FM when you don't need it (Oscillator and Filter FM). Either set FM Source to <i>off</i> or FM Amount to <i>0</i>.
Effects	<ul style="list-style-type: none"> • Set unused effects to <i>Bypass</i>.
LFOs/Envelopes/Modulation	<ul style="list-style-type: none"> • LFOs, Envelopes and Modulation can be used without changing the number of voices at all.

Parameter Index

	Parameter	Page		Parameter	Page		Parameter	Page		Parameter	Page
A	AE (mono)	51	E	Env (Filter)	75	P	Pan (Filter)	76	T	Tempo (Delay FX)	92
	A.Hi.Frq (Vocoder FX)	94		EQ HiBnd (Vocoder FX)	95		Pan Mod (Filter)	77		Tempo (Main Parameter)	124
	A.Lo.Frq (Vocoder FX)	94		EQ LoBnd (Vocoder FX)	95		Pan Mod Source (Filter)	77		T.Factor (Arpeggiator)	104
	Alt1/Alt2 (Oscillator)	62		EQ Middle (Vocoder FX)	95		Panning (Multi)	40		Transpose (Global)	130
	Amount (ModMatrix)	121		EQ Mid Level (Vocoder FX)	96		Pattern (Arpeggiator)	101		Transpose (Multi)	41
	M1F... M8F...M1S...M8S		F	Fade (LFO)	117		Pattern Length (Arp)	105		Triangle (Oscillator)	57
	Amp Mod (Amplifier)	85		Feedback (5.1 Delay FX)	98		Pattern Reset (Arp)	104		Tuning (Global Menu)	130
	Amp Mod Source (Amplifier)	84		Feedback (Delay FX)	92		Pedal (Global Menu)	133		Tx.PrgChg (Global)	130
	Analysis Signal (Voc.)	94		Feedback (Flanger FX)	88		Pitch Mod (Oscillator)	66		Type (Filter)	76
	Arp Accent (Arp.)	105		Feedback (Phaser FX)	88		Pitch Mod Source (Oscillator)	66	V	Vel.Mode (Arpeggiator)	103
	Arp Glide (Arp.)	105		FM (Filter)	77		Polarity (Delay FX)	92		Velo (Filter)	75
	Arp Mode (Arp.)	100		FM Source (Filter)	77		Polarity (Flanger FX)	88		Velo (Amplifier)	84
	Arp Send (Global Menu)	128		FM (Oscillator)	60		Polarity (Phaser FX)	88		Volume (Amplifier)	84
	Arp Step (Arp.)	106		FM Source (Oscillator)	64		Post Gain (Overdrive FX)	89		Volume (Multi)	40
	Arp Steplen (Arp.)	107		Footsw. Parmtr (Global)	133		Predelay (Reverb FX)	96		VU Mode (Multimixer)	44
	Arp Timing (Arp.)	107		Frq.divide (Oscillator)	67		Pressure Curve (Global Menu)	132	W	Waldorf	;-)
	Attack (Envelope)	109		FSL V. (5.1 Delay FX)	98		Pulse (Oscillator)	56			
	Attack (Vocoder FX)	95		FSR V. (5.1 Delay FX)	98		Pulsewidth (Oscillator)	61			
B	Balance (Mixer)	68	G	Glb.Chnl. (Global Menu)	127		PWM (Oscillator)	63			
	Bands (Vocoder FX)	94		Glide Mode (Oscillator)	66		PWM Source (Oscillator)	63			
	Bandwidth (Vocoder FX)	95		Glide Rate (Oscillator)	67	R	Rear SL/R V. (5.1 Delay FX)	98			
	Bank (Multi)	39		H High Key (Multi)	42		Release (Envelope)	109			
	BendRg (Oscillator)	64		HighPass (Reverb FX)	96		Release Vel. Curve (Global Menu)	132			
	Bypass (FX)	87		Hi Offset (Vocoder FX)	95		Resonance (Filter)	75			
C	Center (Phaser FX)	88		Hi Velo (Multi)	42		Resonance (Vocoder FX)	95			
	Channel (Multi)	40	I	Input Gain (Global)	130		RingMod (5 FX)	90			
	Chor/Dlay (Five FX)	90		Input HP (5.1 Dly FX)	98		RingMod (Mixer)	70			
	Clock (Arpeggiator)	101	K	Keytrack (Filter)	75		Routing (Filter)	68			
	Clock (Global Menu)	128		Keytrack (LFO)	117		Rx.Prg Chg (Global Menu)	129			
	Clocked (Delay FX)	91		Keytrack (Oscillator)	64	S	Same Note Overlap (Arpeggiator)	104			
	Clocked (LFO)	117	L	Length (Arpeggiator)	102		Sample & Hold (5 FX)	90			
	Cntr.S V. (5.1 Delay FX)	98		Length (Delay FX)	91		Saw (Oscillator)	54			
	Contrast (Global Menu)	134		Level (Envelope)	110		Semi (Oscillator)	59			
	Ctrl. W...Z (Global Menu)	129		Level Mode (Multimixer)	44		Shape (LFO)	115			
	Ctrl. W...Z (Multi)	42		LFE LP (5.1 Delay FX)	98		Shape (Oscillator)	60			
	Ctr. Send/Recv (Global)	128		Local Ctr. (Global Menu)	128		Shape (Reverb FX)	97			
	Cutoff (Delay FX)	92		Low Key (Multi)	42		Sine (Oscillator)	53			
	Cutoff (Filter)	74		Lowpass (Reverb FX)	96		Size (Reverb FX)	96			
	Cutoff (Overdrive FX)	89		Low Velo (Multi)	42		S. Offset (Vocoder FX)	95			
	Cutoff Mod (Filter)	76	M	Max.Notes (Arpeggiator)	102		Sort Order (Arpeggiator)	103			
D	Damping (Reverb FX)	97		Mix 1/2 (FX)	86		Sound (Multi)	39			
	Decay (Envelope)	109		Mix In to (Global Menu)	131		Source (5 FX)	90			
	Decay (Reverb FX)	97		Mix Level (Global Menu)	131		Source (ModMatrix)	121			
	Decay (Vocoder FX)	95		Mode (Envelope)	108		M1F...M8F...M1S...M8S				
	Delay (5.1 Delay FX)	97		Multi Volume (Multi)	43		Spacing (Phaser FX)	88			
	Delay (5 FX)	91	N	N/E Select (Mixer)	69		Speed (5 FX)	91			
	Delay (Chorus FX)	87		Noise(Ext. (Mixer)	69		Speed (Chorus FX)	87			
	Delay ML/MR (5.1 FX)	99	O	Octave (Oscillator)	59		Speed (Flanger FX)	87			
	Delay S1L/R (5.1 FX)	99		Oct.Range (Arpeggiator)	103		Speed (LFO)	115			
	Depth (5 FX)	91		OnVel.Curve (Global)	131		Speed (Phaser FX)	88			
	Depth (Chorus FX)	87		OS (Global Menu)	135		Startphase (LFO)	117			
	Depth (Flanger FX)	88		Osc 1/2/3 (Mixer)	68		Status (Multi)	41			
	Depth (Phaser FX)	88		Output (Multi)	40		Sub Vol (Oscillator)	67			
	Detune (Multi)	42		Overdrive (5FX)	90		Sustain (Envelope)	109			
	Detune (Oscillator)	60					Sync (Oscillator)	65			
	Diffusion (Reverb FX)	96					Sync (LFO)	116			
	Direction (Arpeggiator)	103					SysEx ID (Global)	127			
	Disp.Time (Global Menu)	134									
	Drive (Filter)	75									
	Drive (Overdrive FX)	89									

Technical Data

Power Supply

Nominal voltage:	AC 12V
Maximum current consumption:	1.0A
Maximum power consumption:	12W

Audio Outputs

(3 x stereo)	
Maximum level:	+10dBm
Dynamic range:	110dB
Frequency range:	0Hz-24kHz

Audio Input

(1 x stereo)	
Maximum level:	+0dBm

Dynamic range: 86dB

Frequency range: 5Hz-24kHz

CV Inputs (microQ Keyboard only)

Hold Pedal: Stereo Jack with a connection to +5V on the ring, for standard Sustain Pedal with open state

CV: 0-5V, 5V out at Ring, Stereo Jack

Dimensions and Weight (microQ Keyboard/Rack version)

Width: 622mm/483mm

Depth (incl. rotary controls): 331mm/92mm

Height: 93mm/89mm

Total weight: 4,5kg/1,7kg

Glossary

Aftertouch

The majority of contemporary keyboards are capable of generating aftertouch messages. On this type of keyboard, when you press harder on a key you are already holding down, a MIDI Aftertouch message is generated. This feature makes sounds even more expressive (e.g. through vibrato).

Aliasing

Aliasing is an audible side effect arising in digital systems as soon as a signal contains harmonics higher than half the sampling frequency.

Amount

Describes to which extent a modulation influences a given parameter.

Amplifier

An amplifier is a component that influences the volume level of a sound via a control signal. This control signal is often generated by an envelope or an LFO.

Arpeggiator

An arpeggiator is a device that splits an incoming MIDI chord into its single notes and repeats them rhythmically. Most arpeggiators feature different sequence modes to cover a wide range of applications. Typical controls for an arpeggiator are the octave range, the direction, the speed and the clock, which means the repetition interval. Some arpeggiators also feature preset or programmable rhythm patterns.

Attack

An envelope parameter. "Attack" is a term that describes the ascent rate of an envelope from its starting point to the point where it reaches its highest value. The Attack phase is initiated immediately after a trigger signal is received, i.e. after you play a note on the keyboard.

Band Pass Filter

A band pass filter allows only those frequencies around the cutoff frequency to pass. Frequencies both below and above the cutoff point are damped.

Band Stop Filter

A band stop filter does the opposite of a band pass filter, i.e. it dampens only the frequencies around the cutoff point and lets all other frequencies pass through.

Clipping

Clipping is a sort of distortion that occurs when a signal exceeds its maximum value. The curve of a clipped signal is dependent of the system where the clipping takes place. In the analog domain, clipping effectively limits the signal to its maximum level. In the digital domain, clipping is similar to a numerical overflow and so the polarity of the signal's part above the maximum level is negated.

Control Change (Controllers)

MIDI messages enable you to manipulate the response of a sound generator to a significant degree.

This message essentially consists of two components:

- The Controller number, which defines the element to be influenced. It can be between 0 and 120.
- The Controller value, which determines the extent of the modification.

Controllers can be used for effects such as slowly swelling vibrato, changing the stereo panorama position and influencing filter frequency.

CV

CV is the abbreviation for control voltage. In analog synthesizers, control voltages are used to control sound parameters like pitch, cutoff frequency etc. E.g. to get a tremolo effect, the output signal of a LFO must be routed to the CV input of one or more oscillators.

Decay

"Decay" describes the descent rate of an envelope once the Attack phase has reached its zenith and the envelope drops to the level defined for the Sustain value.

Filter

A filter is a component that allows some of a signal's frequencies to pass through it and dampens other frequencies. The most important aspect of a filter is the filter cutoff frequency. Filters generally come in four categories: low pass, high pass, band pass, and band stop. A low pass filter dampens all frequencies above the cutoff frequency. A high pass filter in turn

dampens the frequencies below the cutoff. The band pass filter allows only those frequencies around the cutoff frequency to pass, all others are dampened. A band stop filter does just the opposite, i.e. it dampens only the frequencies around the cutoff frequency. The most common type is the low pass filter.

Filter Cutoff Frequency

The filter cutoff frequency is a significant factor for filters. A low pass filter dampens the portion of the signal that lies above this frequency. Frequencies below this value are allowed to pass through without being processed.

Envelope

An envelope is used to modulate a sound-shaping component within a given time frame so that the sound is changed in some manner. For instance, an envelope that modulates the cutoff frequency of a filter opens and closes this filter so that some of the signal's frequencies are filtered out. An envelope is started via a trigger, usually a fixed trigger. Normally, the trigger is a MIDI Note. The classic envelope consists of four individually variable phases: Attack, Decay, Sustain and Release. This sequence is called an ADSR envelope. Attack, Decay and Release are time or slope values, and Sustain is a variable volume level. Once an incoming trigger is received, the envelope runs through the Attack and Decay phases until it reaches the programmed Sustain level. This level remains constant until the trigger is terminated. The envelope then initiates the Release phase until it reaches the minimum value.

Gate

The term "Gate" has different meanings in a technical context. Like a real gate, it describes something that can be open or closed, or - to use a technical term - active or inactive. A gate in sense of a device is a unit, that damps a signal passing through corresponding to specific conditions. For example, in a noise gate a signal is cut off when its level falls above a predetermined threshold.

Gate stands also for a control signal of analog synthesizer systems. A keyboard generates an active gate signal as long as a key is held down. When the key is released, the gate signal becomes inactive again. An envelope generator can use this signal for its trigger purposes, and as a result a VCA unit can be controlled.

High Pass Filter

A high pass filter dampens all frequencies below its cutoff frequency. Frequencies above the cutoff point are not affected.

LFO

LFO is an acronym for low-frequency oscillator. The LFO generates a periodic oscillation at a low frequency and features variable waveshapes. Similar to an envelope, an LFO can be used to modulate a sound-shaping component.

Low Pass Filter

Synthesizers are often equipped with a low pass filter. A low pass filter dampens all frequencies above its cutoff frequency. Frequencies below the cutoff point are not affected.

MIDI

The acronym MIDI stands for "musical instrument digital interface." It was developed in the early '80s so that diverse types of electronic musical instruments by different manufacturers could interact. At the time a communications standard for heterogeneous devices did not exist, so MIDI was a significant advance. It made it possible to link all devices with one another through simple, uniform connections. Essentially, this is how MIDI works: One sender is connected to one or several receivers. For instance, if you want to use a computer to play the Pulse, then the computer is the sender and the Pulse acts as the receiver. With a few exceptions, the majority of MIDI devices are equipped with two or three ports for this purpose: MIDI In, MIDI Out and in some cases MIDI Thru. The sender transfers data to the receiver via the MIDI Out jack. Data are sent via a cable to the receiver's MIDI In jack.

MIDI Thru has a special function. It allows the sender to transmit to several receivers. It routes the incoming signal to the next device without modifying it. Another device is simply connected to this jack, thus creating a chain through which the sender can address a number of receivers. Of course it is desirable for the sender to be able to address each device individually. Consequently, there is a rule which is applied to ensure each device responds accordingly.

MIDI Channel

This is a very important element of most messages. A receiver can only respond to incoming messages if its receive channel is set to the same channel as the one the sender is using to transmit data. Subsequently, the sender can address specific receivers individually. MIDI Channels 1 through 16 are available for this purpose.

MIDI Clock

The MIDI Clock message determines the tempo of a piece of music. It serves to synchronize processes based on time.

Modulation

A modulation influences or changes a sound-shaping component via a modulation source. Modulation sources include envelopes, LFOs or MIDI messages. The modulation destination is sound-shaping component such as a filter or a VCA.

Note on / Note off

This is the most important MIDI message. It determines the pitch and velocity of every generated note. The time of arrival is simultaneously the start time of the note. Its pitch is derived from the note number, which lies between 0 and 127. The velocity lies between 1 and 127. A value of 0 for velocity is similar to "Note Off".

Panning

The process of changing the signal's position within the stereo panorama.

Pitchbend

Pitchbend is a MIDI message. Although pitchbend messages are similar in function to control change messages, they are a distinct type of message. The reason for this distinction is that the resolution of a pitchbend message is substantially higher than that of a conventional Controller message. The human ear is exceptionally sensitive to deviations in pitch, so the higher resolution is used because it relays pitchbend information more accurately.

Program Change

These are MIDI messages that switch sound programs. Program numbers 1 through 128 can be changed via program change messages.

Release

An envelope parameter. The term "Release" describes the descent rate of an envelope to its minimum value after a trigger is terminated. The Release phase begins immediately after the trigger is terminated, regardless of the envelope's current status. For instance, the Release phase may be initiated during the Attack phase.

Resonance

Resonance is an important filter parameter. It emphasizes a narrow bandwidth around the filter cutoff frequency by amplifying these frequencies. This is one of the most popular methods of manipulating sounds. If you substantially increase the resonance, i.e, to a level where the filter begins self-oscillation, then it will generate a relatively clean sine waveform.

Sustain

An envelope parameter. The term "Sustain" describes the level of an envelope that remains constant after it has run through the Attack and Decay phases. Sustain lasts until the trigger is terminated.

System Exclusive Data

System exclusive data allow access to the heart of a MIDI device. They enable access to data and functions that no other MIDI messages are able to address. "Exclusive" in this context means that these data pertain only to one device type or model. Every device has unique system exclusive data. The most common applications for SysEx data include transfer of entire memories and complete control of a device via a computer.

Trigger

A trigger is a signal that activates events. Trigger signals are very diverse. For instance, a MIDI note or an audio signal can be used as a trigger. The events a trigger can initiate are also very diverse. A common application for a trigger is its use to start an envelope.

VCA

VCA is the acronym for voltage-controlled amplifier. A VCA is a component that influences the volume level of a sound via a control voltage. This is often generated by an envelope or an LFO.

VCF

VCF is the acronym for voltage-controlled filter. It is a filter component that allows you to manipulate the filter parameters via control voltages.

Volume

The term describes a sound's output level.

Controller Numbers

Controllers marked with * don't change the Sound program but can perform temporary modulations or other tasks.

Ctrl #	Controller Range	Controller Name or Sound Parameter	Value Range
0	- not used -	Bank Select MSB	- not used -
1	0...127	Modulation Wheel*	0...127
2	0...127	Breath Control*	0...127
3	- not used -	<i>undefined</i>	- not used -
4	0...127	Foot Control*	0...127
5	0...127	Glide Rate	0...127
6	- not used -	Data Entry	- not used -
7	0...127	Channel Volume*	0...127
8	- not used -	Balance	- not used -
9	- not used -	<i>undefined</i>	- not used -
10	0...127	Pan*	L64...R63
11	- not used -	Expression	- not used -
12	0...9	Arp Range	1...10 octaves
13	0...15	Arp Length	1...16 steps
14	0...3	Arp Active	off, on, one shot, hold
15	0...5	LFO 1 Shape	sine, triangle, square, sawtooth, random, S&H
16	0...127	LFO 1 Speed	0...127 or 256 bars...1/96
17	0...1	LFO 1 Sync	off, on
18	0...127	LFO 1 Delay	0...127
19	0...5	LFO 2 Shape	sine, triangle, square, sawtooth, random, S&H
20	0...127	LFO 2 Speed	0...127 or 256 bars...1/96
21	0...1	LFO 2 Sync	off, on
22	0...127	LFO 2 Delay	0...127
23	0...5	LFO 3 Shape	sine, triangle, square, sawtooth, random, S&H
24	0...127	LFO 3 Speed	0...127 or 256 bars...1/96
25	0...1	LFO 3 Sync	off, on
26	0...127	LFO 3 Delay	0...127
27	16, 28, 40...112	Osc 1 Octave	128'...1/2'
28	52...76	Osc 1 Semitone	-12...+12
29	0...127	Osc 1 Detune	-64...+63
30	0...127	Osc 1 FM	0...127
31	0...5	Osc 1 Shape	pulse, saw, triangle, sine, alt 1, alt 2

Ctrl #	Controller Range	Controller Name or Sound Parameter	Value Range
32	0...3	Bank Select LSB*	Bank A...D
33	0...127	Osc 1 PW	0...127
34	0...127	Osc 1 PWM	-64...+63
35	16, 28, 40...112	Osc 2 Octave	128'...1/2'
36	52...76	Osc 2 Semitone	-12...+12
37	0...127	Osc 2 Detune	-64...+63
38	0...127	Osc 2 FM	0...127
39	0...5	Osc 2 Shape	pulse, saw, triangle, sine, alt 1, alt 2
40	0...127	Osc 2 PW	0...127
41	0...127	Osc 2 PWM	-64...+63
42	16, 28, 40...112	Osc 3 Octave	128'...1/2'
43	52...76	Osc 3 Semitone	-12...+12
44	0...127	Osc 3 Detune	-64...+63
45	0...127	Osc 3 FM	0...127
46	0...5	Osc 3 Shape	pulse, saw, triangle, sine, alt 1, alt 2
47	0...127	Osc 3 PW	0...127
48	0...127	Osc 3 PWM	-64...+63
49	0...1	Sync	off, on
50	0...127	Pitchmod	-64...+63
51	0...9	Glide Mode	see "Glide Mode"
52	0...127	Osc 1 Level	0...127
53	0...127	Osc 1 Balance	F1 64...mid...F2 63
54	0...127	Ringmod Level	0...127
55	0...127	Ringmod Balance	F1 64...mid...F2 63
56	0...127	Osc 2 Level	0...127
57	0...127	Osc 2 Balance	F1 64...mid...F2 63
58	0...127	Osc 3 Level	0...127
59	0...127	Osc 3 Balance	F1 64...mid...F2 63
60	0...127	N/E Level	0...127
61	0...127	N/E Balance	F1 64...mid...F2 63
62	- not used -	<i>undefined</i>	- not used -
63	- not used -	<i>undefined</i>	- not used -

Ctrl #	Controller Range	Controller Name or Sound Parameter	Value Range
64	0...127	Sustain Pedal*	off, on
65	0...127	Glide Active	off, on
66	0...127	Sostenuto	off, on
67	0...127	Routing	serial/parallel
68	0...10	Filter 1 Type	see "Filter Types"
69	0...127	Filter 1 Cutoff	0...127
70	0...127	Filter 1 Resonance	0...127
71	0...127	Filter 1 Drive	0...127
72	0...127	Filter 1 Keytrack	-200%...+197%
73	0...127	Filter 1 Env. Amount	-64...+63
74	0...127	Filter 1 Env. Velocity	-64...+63
75	0...127	Filter 1 CutoffMod	-64...+63
76	0...127	Filter 1 FM	off, 1...127
77	0...127	Filter 1 Pan	L64...center...R63
78	0...127	Filter 1 Panmod	-64...+63
79	0...10	Filter 2 Type	see "Filter Types"
80	0...127	Filter 2 Cutoff	0...127
81	0...127	Filter 2 Resonance	0...127
82	0...127	Filter 2 Drive	0...127
83	0...127	Filter 2 Keytrack	-200%...+197%
84	0...127	Filter 2 Env. Amount	-64...+63
85	0...127	Filter 2 Env. Velocity	-64...+63
86	0...127	Filter 2 CutoffMod	-64...+63
87	0...127	Filter 2 FM	off, 1...127
88	0...127	Filter 2 Pan	L64...center...R63
89	0...127	Filter 2 Panmod	-64...+63
90	0...127	Amp Volume	0...127
91	0...127	Amp Velocity	-64...+63
92	0...127	Amp Mod	-64...+63
93	0...127	FX 1 Mix	0...127
94	0...127	FX 2 Mix	0...127
95	0...127	FE Attack	0...127

Ctrl #	Controller Range	Controller Name or Sound Parameter	Value Range
96	0...127	FE Decay	0...127
97	0...127	FE Sustain	0...127
98	0...127	FE Decay 2	0...127
99	0...127	FE Sustain 2	0...127
100	0...127	FE Release	0...127
101	0...127	AE Attack	0...127
102	0...127	AE Decay	0...127
103	0...127	AE Sustain	0...127
104	0...127	AE Decay 2	0...127
105	0...127	AE Sustain 2	0...127
106	0...127	AE Release	0...127
107	0...127	E3 Attack	0...127
108	0...127	E3 Decay	0...127
109	0...127	E3 Sustain	0...127
110	0...127	E3 Decay 2	0...127
111	0...127	E3 Sustain 2	0...127
112	0...127	E3 Release	0...127
113	0...127	E4 Attack	0...127
114	0...127	E4 Decay	0...127
115	0...127	E4 Sustain	0...127
116	0...127	E4 Decay 2	0...127
117	0...127	E4 Sustain 2	0...127
118	0...127	E4 Release	0...127
119	- not used -	<i>undefined</i>	- not used -
120	0	All Sound Off*	immediate silence
121	0	Reset All Controllers*	resets all controllers
122	0...127	Local Control	Local Control Off/On
123	0	All Notes Off*	releases all voices
124	- not used -	Omni Mode Off	- not used -
125	- not used -	Omni Mode On	- not used -
126	- not used -	Poly Mode On/Off	- not used -
127	- not used -	Poly Mode On	- not used -

MIDI Implementation Chart

Datum: March/28/2002

Version: 2.18

Modell: Waldorf microQ/microQ Keyboard

Function		Transmitted	Recognized	Remarks
Basic	Default	1	1	Memorized
Channel	Changed	1 – 16	1 – 16	
Mode	Default	3	3	Memorized
	Messages	×	×	
	Altered	3, 3b	1, 3, 3b	
Note		0 – 127	0 – 127	microQ: only transmitted when "Arp Send" is active
Number	True Voice	0 – 127	0 – 127	
Velocity	Note ON	○	○	v = 1 – 127
	Note OFF	○	○	v = 0 – 127
After Touch	Key's	×	○	Transmitted by microQ Keyboard only
	Ch's	○	○	
Pitch Bend		○	○	14bit resolution, transmitted by microQKeyboard only
Control Change *2	1	○	○	Modwheel *3
	2	×	○	Breath Control
	4	×	○	Foot Control
	5	×	○	Portamento Time
	7	×	○	Channel Volume
	10	×	○	Pan
	32	○	○	Bank Select LSB
	64	○	○	Sustain Pedal *4
	65	×	○	Portamento On/Off
66	×	○	Sostenuto Pedal	
Prog Change	True #	*****	1 – 100 1 – 100	*5
System Exclusive		○	○	
System Common	Song Pos	×	○	
	Song Sel	×	×	
	Tune	×	×	
System Real Time	Clock	○	○	MIDI Clock
	Commands	○	○	Start, Stop, Continue
Aux Messages	Local ON/OFF	×	○	Memorized
	All Notes OFF	○	○	
	Active Sense	×	○	
	Reset	×	○	
	All Sound OFF	○	○	Issued by Power button
Notes:		*1 Mode 3b is known as MULTI Mode. *2 Please see the chapters "Control W...Z", "MIDI Control" and "Appendix Controller Numbers" for all controllers that can be sent and received. *3 ModWheel is transmitted by microQ Keyboard only *4 Sustain Pedal is transmitted by microQ Keyboard only if additional pedal is connected *5 Bank Select LSB is used to switch between Banks A to D.		

Mode 1: OMNI ON, POLY

Mode 2: OMNI ON, MONO

○: Yes

Mode 3: OMNI OFF, POLY

Mode 4: OMNI OFF, MONO

×: No



Konformitätserklärung
Declaration of Conformity

Für das folgend bezeichnete Erzeugnis

For the following named product

Waldorf microQ Synthesizer

wird hiermit bestätigt, daß es den Schutzanforderungen entspricht, die in der Richtlinie 89/336/FWG des Rates zur Angleichung der Rechtsvorschriften der Mitgliedstaaten über die elektromagnetische Verträglichkeit festgelegt sind; außerdem entspricht es den Vorschriften des Gesetzes über die elektromagnetische Verträglichkeit von Geräten (EMVG) vom 30. August 1995.

will be hereby declared that it conforms to the requirements of the Council Directive 89/336/FWG for radio frequency interference. It also complies with the regulations about radio interference of electronic devices dated on August 30th, 1995.

Zur Beurteilung des Erzeugnisses hinsichtlich der elektromagnetischen Verträglichkeit wurden folgende einschlägige harmonisierte Normen herangezogen:

The following standards have been used to declare conformity:

- EN 50 082-1 : 1992 , EN 50 081-1 : 1992 , EN 60065 : 1993

Diese Erklärung wird verantwortlich für den Hersteller abgegeben:

This declaration has been given responsibly by the manufacturer:

Waldorf Electronics GmbH
Neustraße 12
D-53498 Waldorf

Waldorf, 01.07.2000

A handwritten signature in black ink, consisting of several loops and a long horizontal stroke, positioned below the printed name.

Wolfgang Düren, Geschäftsführer
Wolfgang Düren, Managing Director

FCC Information (U.S.A.)

1. IMPORTANT NOTICE: DO NOT MODIFY THIS UNIT! This product, when installed as indicated in the instructions contained in this Manual, meets FCC requirements. Modifications not expressly approved by Waldorf may void your authority, granted by the FCC, to use this product.

2. IMPORTANT: When connecting this product to accessories and/or another product use only high quality shielded cables. Cable/s supplied with this product **MUST** be used. Follow all installation instructions. Failure to follow instructions could void your FCC authorisation to use this product in the USA.

3. NOTE: This product has been tested and found to comply with the requirements listed in FCC Regulations, Part 15 for Class „B“ digital devices. Compliance with these requirements provides a reasonable level of assurance that your use of this product in residential environment will not result in harmful interference with other electronic devices. This equipment generates/uses radio frequencies and, if not installed and used according to the instructions found in the users manual, may cause interference harmful to the operation of other electronic devices. Compliance with FCC regulations does not guarantee that interference will not occur in all installations. If this product is found to be the source of interference, which can be determined by turning the unit „OFF“ and „ON“, please try to eliminate the problem by using one of the following measures:

Relocate either this product or the device that is being affected by the interference.

Utilise power outlets that are on branch (Circuit breaker or fuse) circuits or install AC line filter/s.

In the case of radio or TV interference, relocate/reorient the antenna. If the antenna lead-in is 300 ohm ribbon lead, change the lead-in to co-axial type cable.

If these corrective measures do not produce satisfactory results, please contact the local retailer authorised to distributed this type of product.

The statements above apply **ONLY** to products distributed in the USA.

CANADA

The digital section of this apparatus does not exceed the „Class B“ limits for radio noise emissions from digital apparatus set out in the radio interference regulation of the Canadian Department of Communications.

Le present appareil numerique n'emet pas de briut radioelectriques depassant les limites applicables aux appareils numeriques de la „Classe B“ prescrites dans la reglement sur le brouillage radioelectrique edicte par le Ministre Des Communications du Canada.

This only applies to products distributed in the USA.

Ceci ne s'applique qu'aux produits distribués dans Canada.

Other Standards (Rest of World)

This product complies with the radio frequency interference requirements of the Council Directive 89/336/EC.

Cet appareil est conforme aux prescriptions de la directive communautaire 89/336/EC.

Dette apparat overholder det gaeldenda EF-direktiv vedrørendareadiostøj.

Diese Geräte entsprechen der EG-Richtlinie 89/336/EC.



©Waldorf Electronics 2002 • All rights reserved • Printed in Germany
Waldorf Electronics GmbH • Schloß Ahrenthal • D-53489 Sinzig • Germany
Phone: +49-(0)180-5-874000-9764-0 • Fax +49-(0)2642-9940-77
<http://www.waldorf-music.com> • info@waldorf-music.com

